

Evaluation Board and Circuit

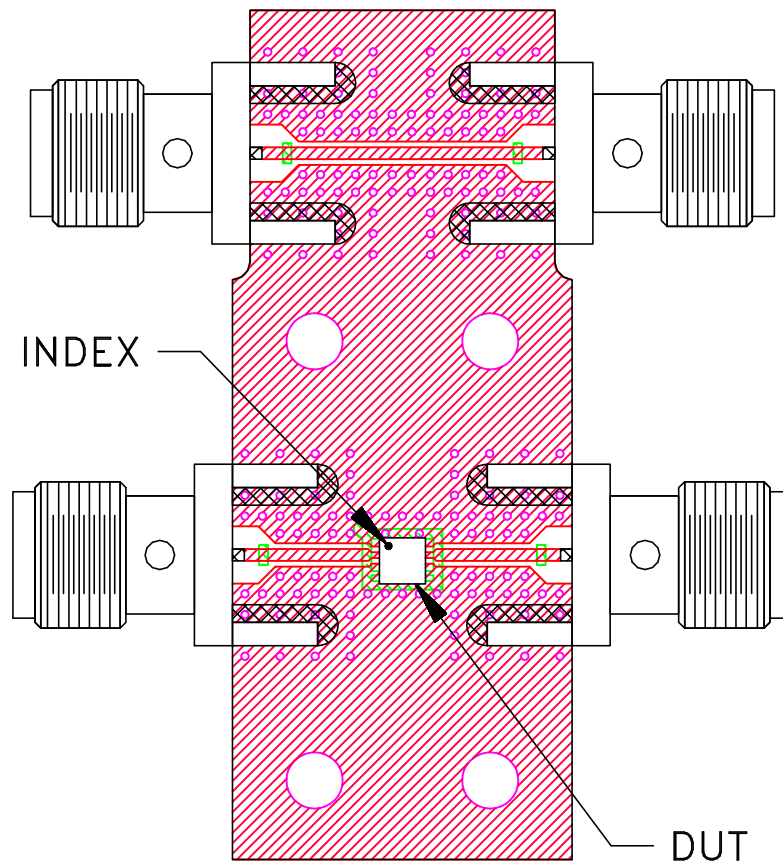

TB-1041-2-63+

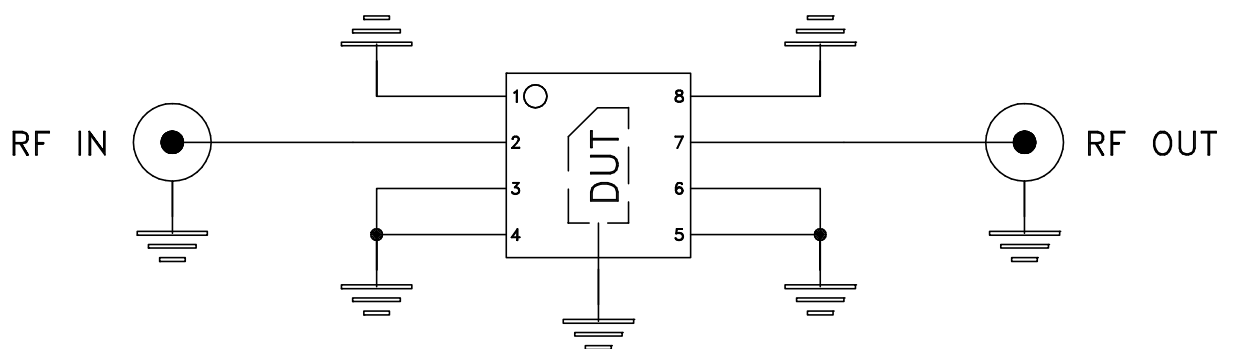

Schematic Diagram

Notes:

1. 50 Ohm SMA Female connectors.
2. PCB Material: R04350 or equivalent,
Dielectric Constant=3.5, Thickness=.010 inch.

 **Mini-Circuits®**