

Evaluation Board and Circuit

TB-1090+

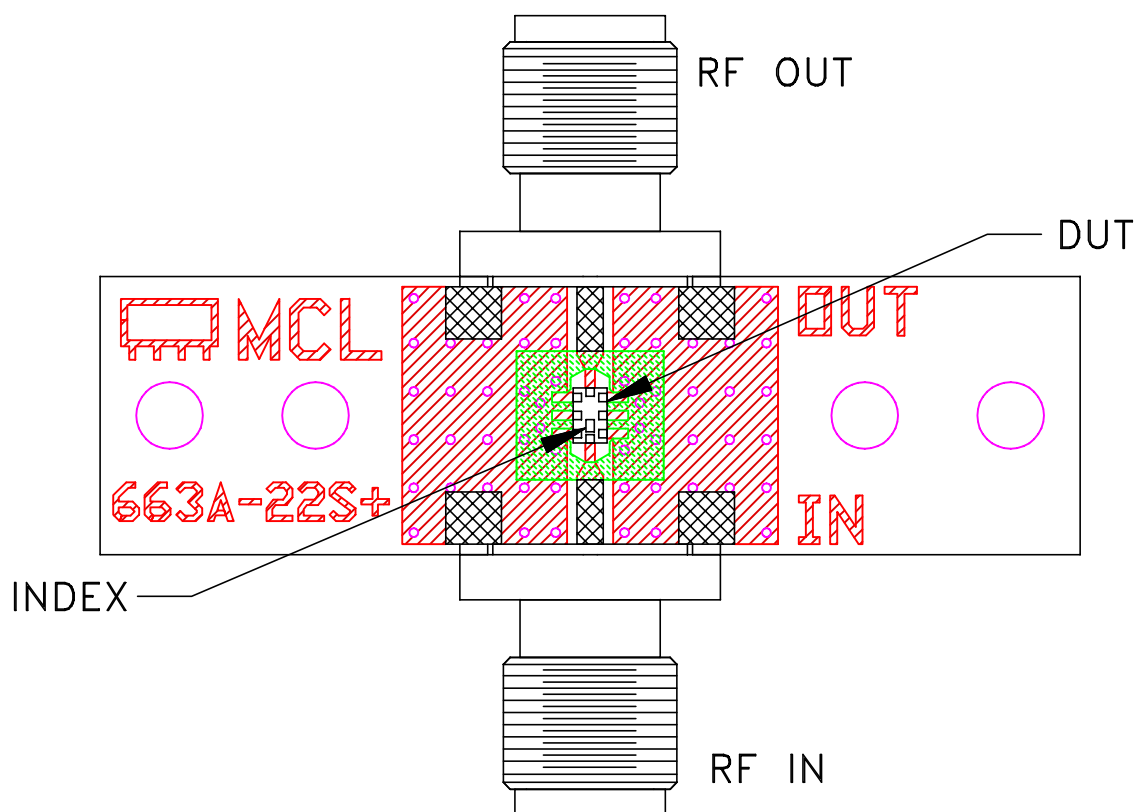

Schematic diagram

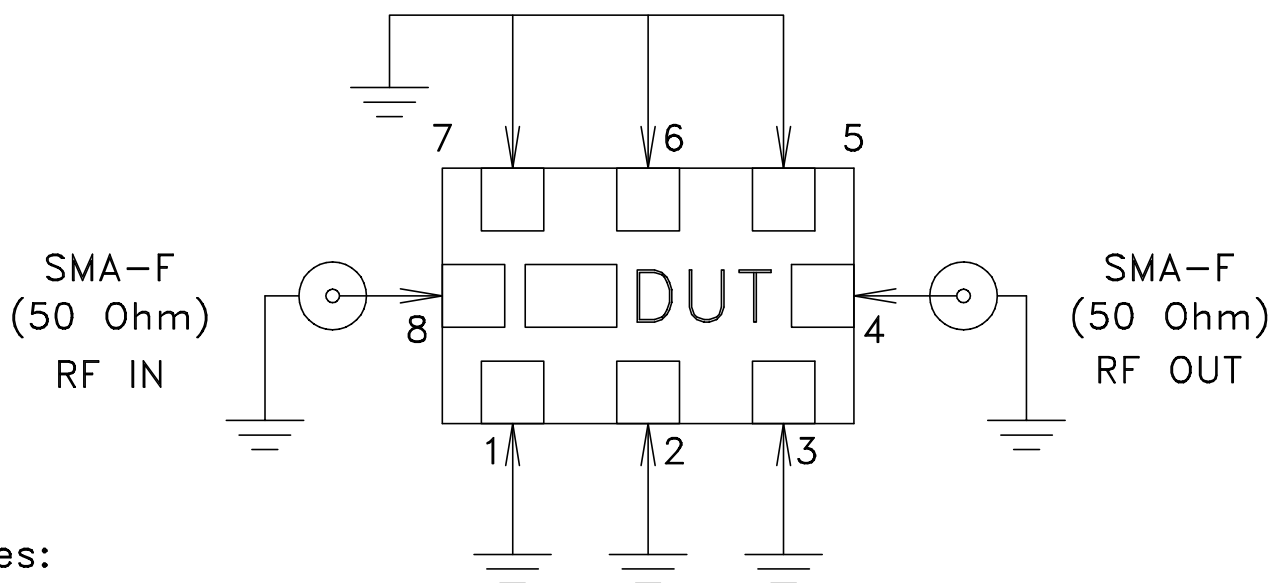

Notes:

1. 50 Ohm SMA Female connectors.
2. PCB Material: ROGERS (R04350B), OR Equivalent
Dielectric Constant=3.48, Thickness=.020inch.

 **Mini-Circuits®**