

Evaluation Board and Circuit

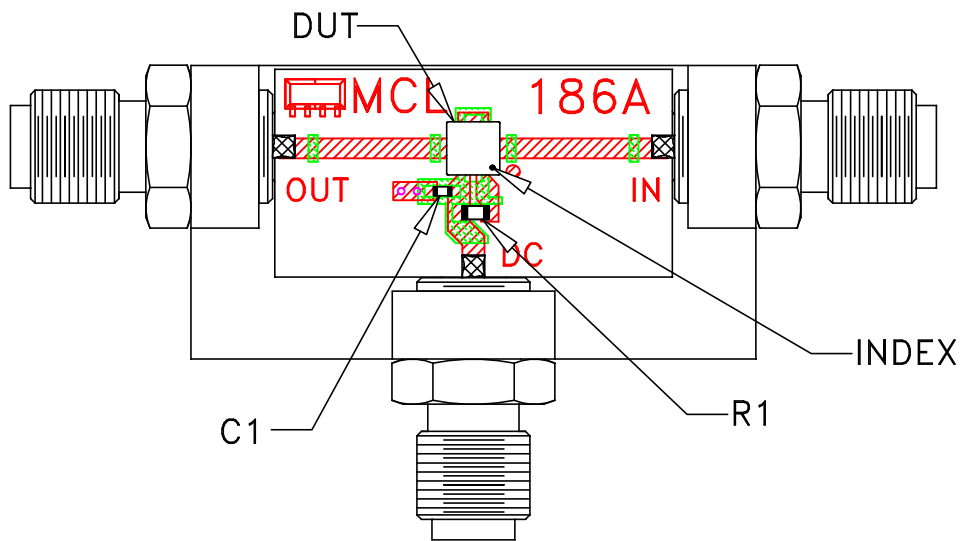

TB-186-5A+

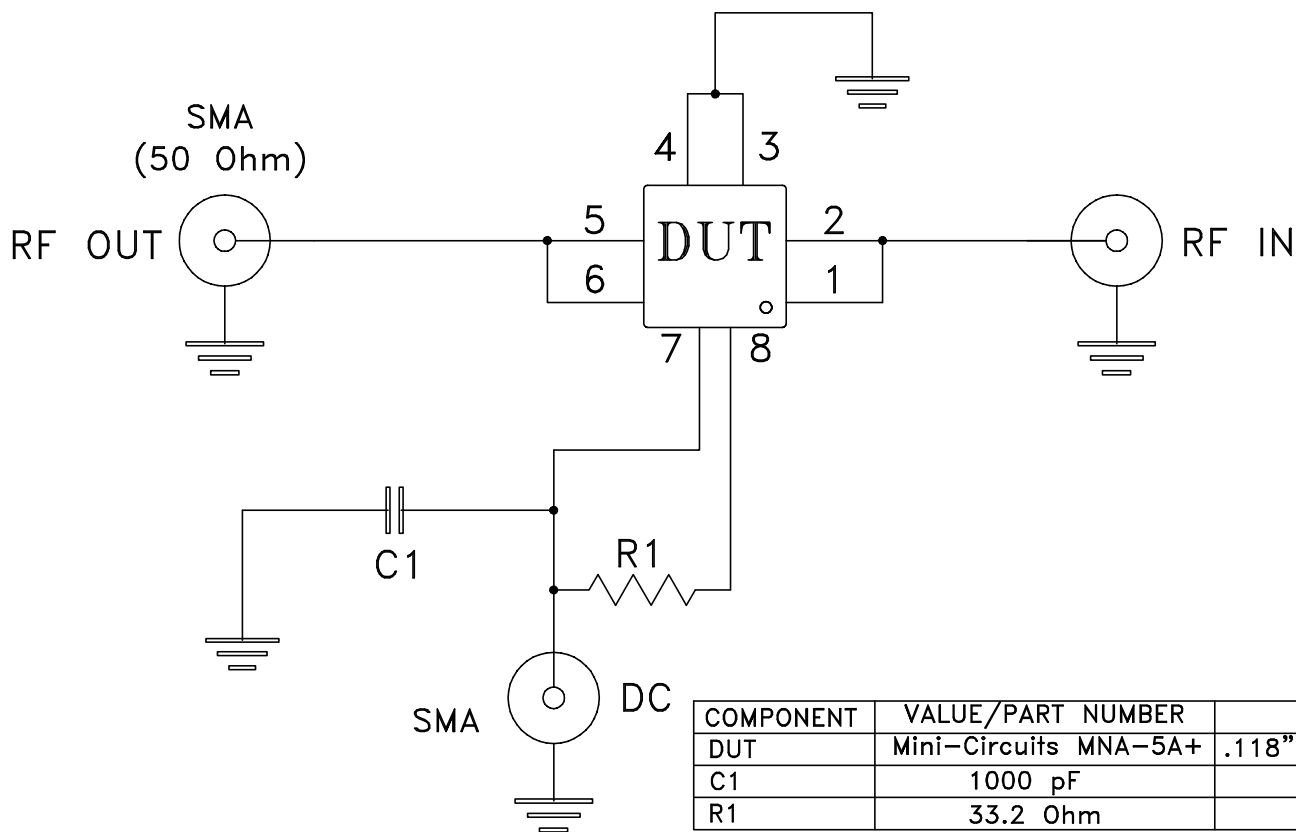

COMPONENT	VALUE/PART NUMBER	SIZE
DUT	Mini-Circuits MNA-5A+	.118"X.118"(3X3MM)
C1	1000 pF	0603
R1	33.2 Ohm	0805

Schematic Diagram

Notes:

1. SMA Female connectors.
2. PCB Material: Rogers R04350 or equivalent, Dielectric Constant=3.5, Thickness=.020 inch.
3. Pins 1 and 6 have no internal connecton.
4. Paddle underneath DUT must be grounded.

 **Mini-Circuits®**