

# Evaluation Board and Circuit

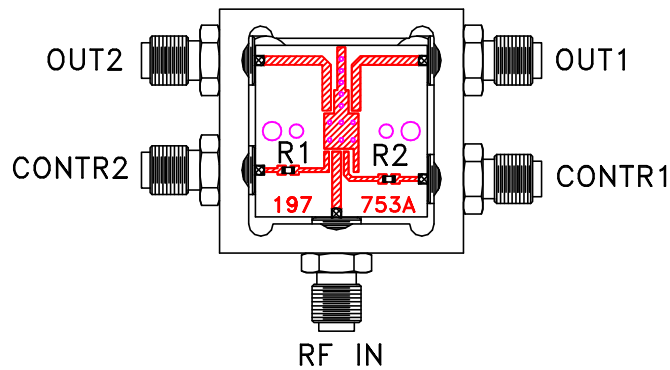

TB-204

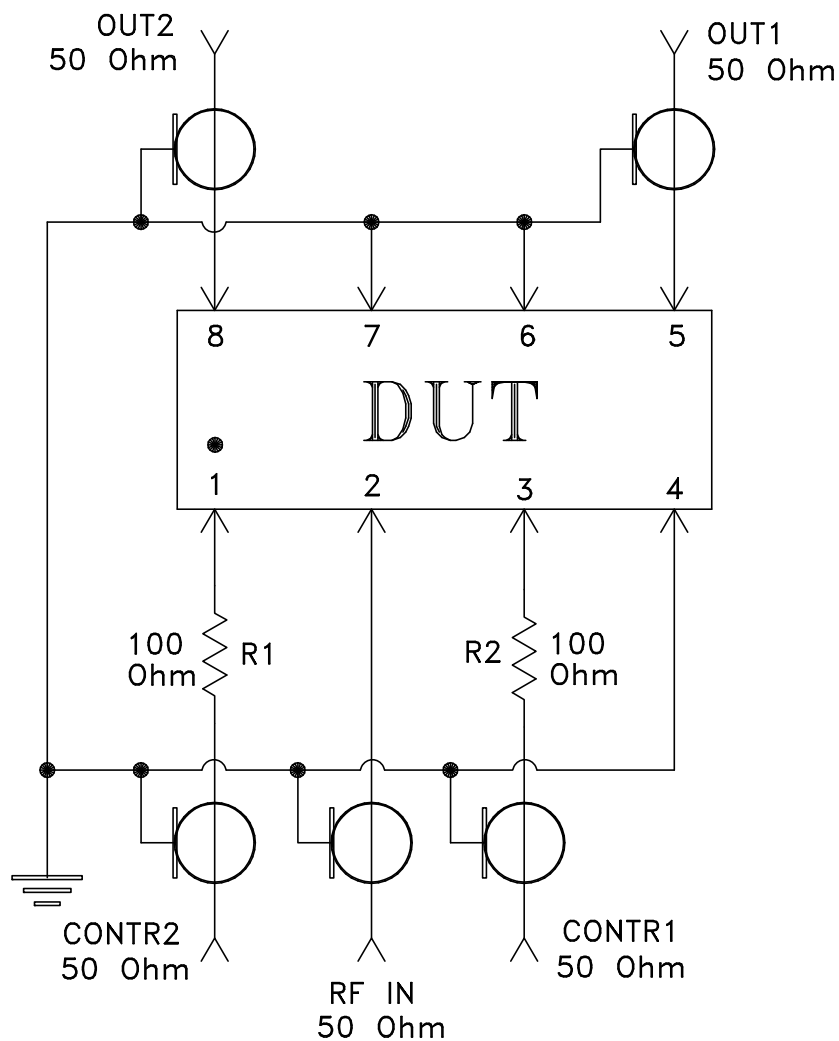

Schematic Diagram

## Notes:

1. SMA Female connectors.
2. PCB Material: Rogers RO4350 or equivalent,  
Dielectric Constant=3.5, Thickness=.020 inch.

 **Mini-Circuits®**