

Evaluation Board and Circuit

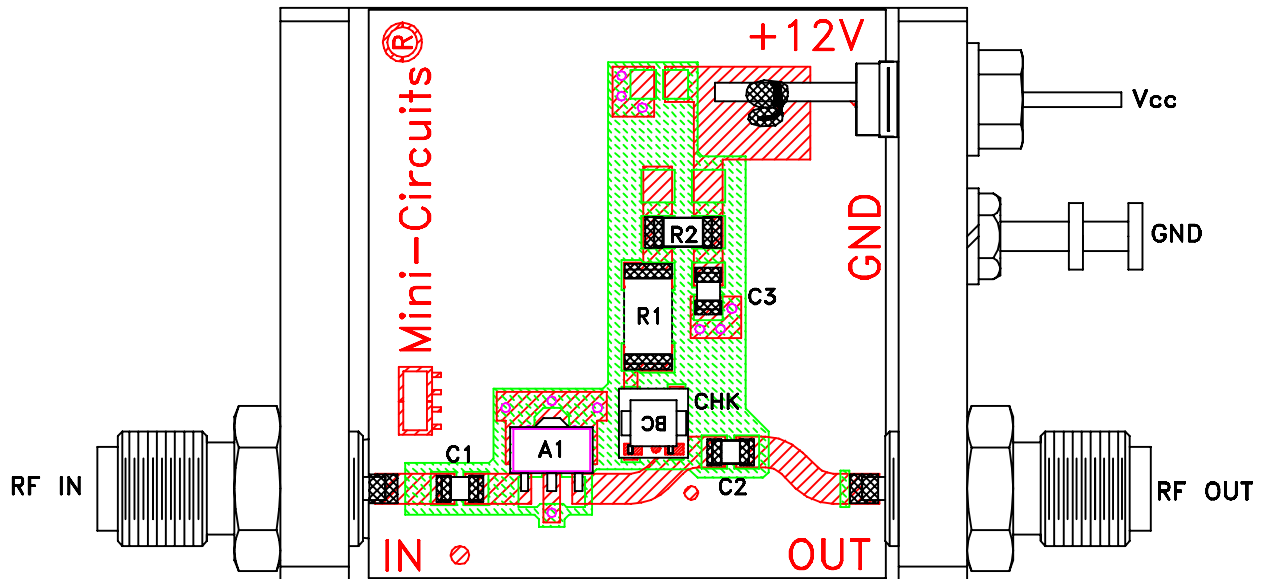

TB-409-5+

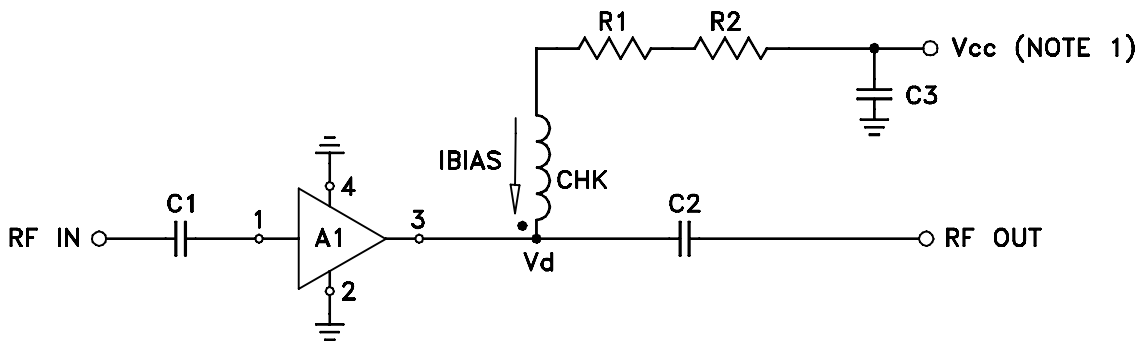

COMPONENT	VALUE
A1	Gali-5(+)
C1 (NOTE 4)	2400 pF
C2 (NOTE 4)	2400 pF
C3 (bypass)	0.1 uF
R1	115 Ohms, 0.75W
R2	2.21 Ohms, 0.25W
CHK	Mini-Circuits TCCH-80+

Schematic Diagram

NOTE:

1. Vcc voltage: $+12 \pm 0.2V$.
2. SMA Female connectors.
3. PCB material: Rogers R04350 or equivalent, dielectric constant=3.5, dielectric thickness=.030 inch.
4. Capacitors, C1 & C2 should be free of resonance up to the highest frequency specified.

 **Mini-Circuits®**