

# Evaluation Board and Circuit

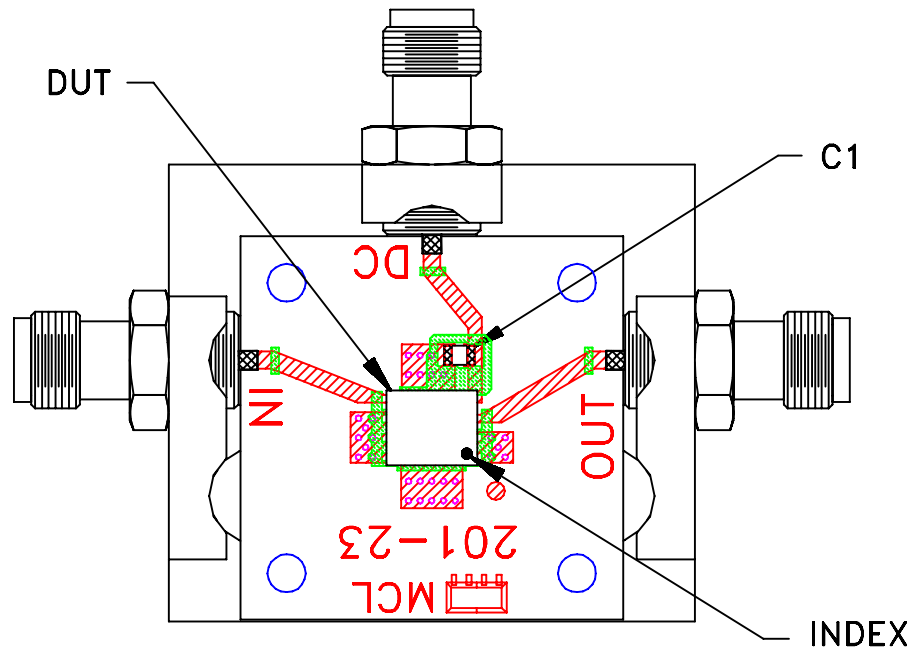

TB-616-4+

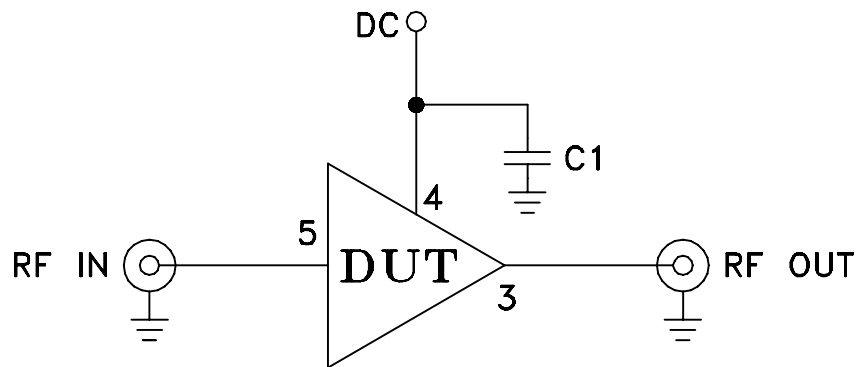

COMPONENT	VALUE
DUT	YSF-232+
C1	1000 pF

## Schematic Diagram

### Notes:

1. 50 Ohm SMA Female connectors.
2. PCB Material: R04350 or equivalent,  
Dielectric Constant=3.5, Thickness=.020 inch.

 **Mini-Circuits®**