

Evaluation Board and Circuit

To be used with Mini-Circuits 50 Ohm 2.92 connectors B20-118-F1+.
Connectors are sold separately.

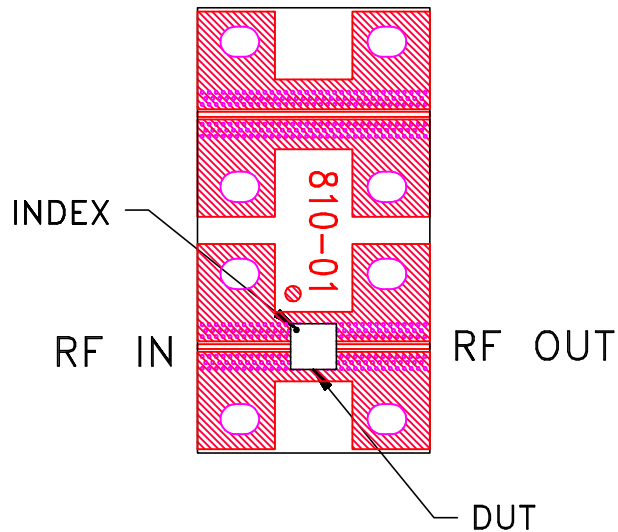

TB-844-962+

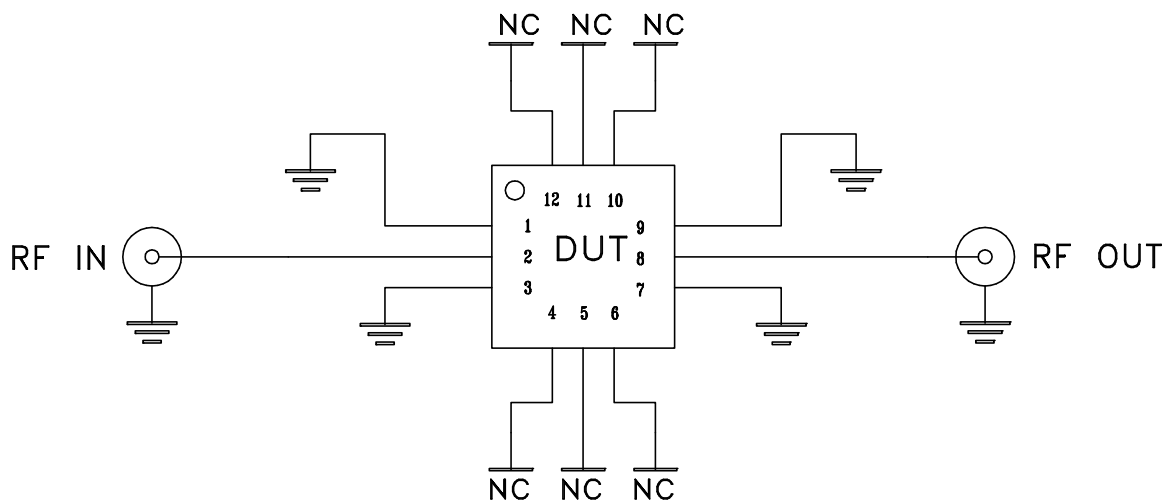

Schematic Diagram

Note:

PCB Material: R04350 or equivalent,
Dielectric Constant=3.5, Thickness=.0066 inch.

 **Mini-Circuits®**