

Evaluation Board and Circuit

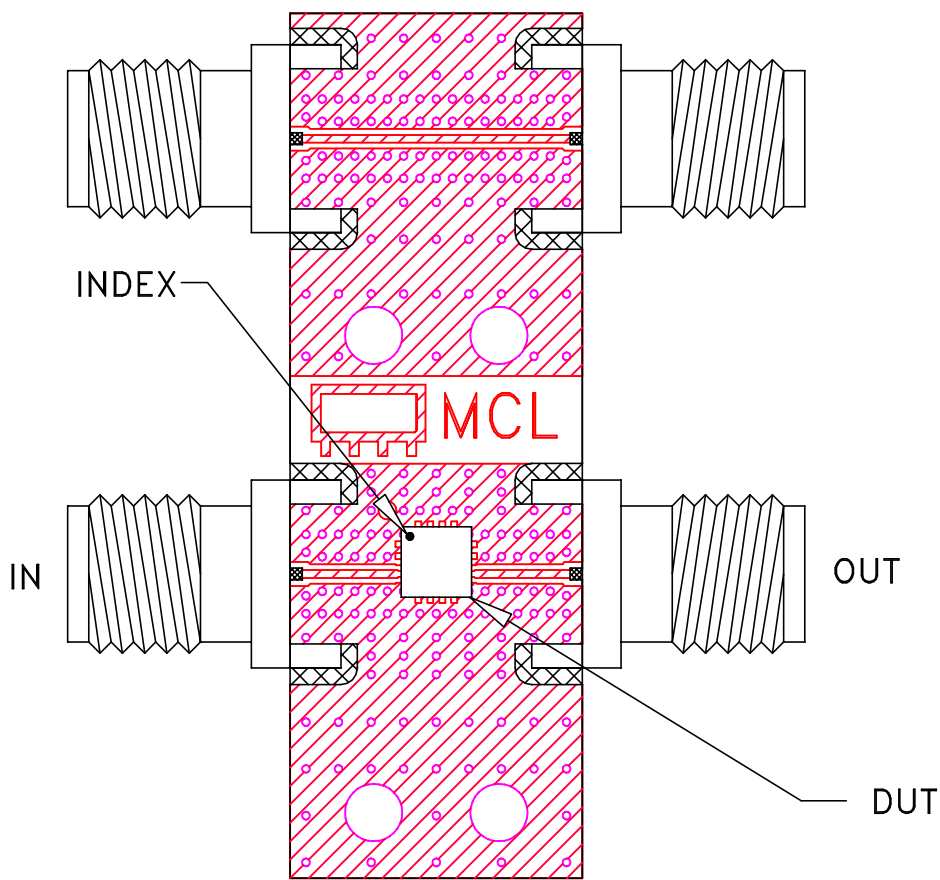

TB-967-63M+

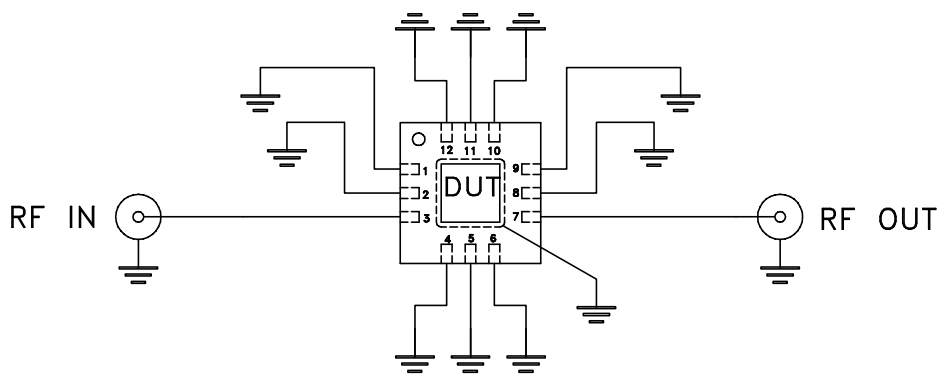

Schematic Diagram

1. 50 Ohm SMA Female connectors.
2. PCB Material: R04003 or equivalent,
Dielectric Constant=3.5, Thickness=.008 inch.

 **Mini-Circuits®**