

Evaluation Board and Circuit

SEE DETAIL "A"

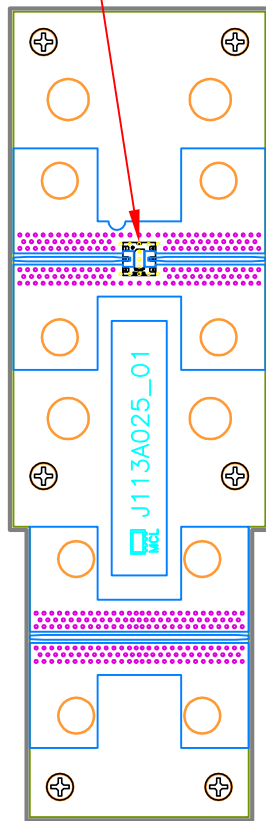

INDEX — DUT

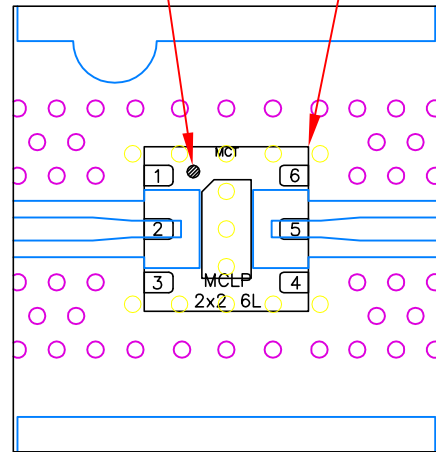

DETAIL "A"
(SCALE 5:1)

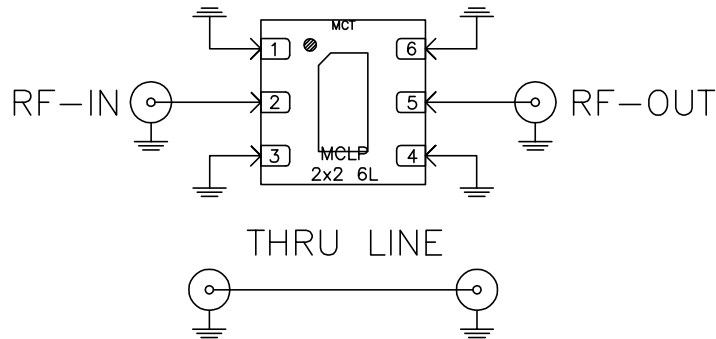

SCHEMATIC DIAGRAM

Function	Pad
RF-IN	2
RF-OUT	5
GND	1,3,4,6

Notes:

2. PCB Material: Roger R04350B or equivalent,
Dielectric constant=3.5, Thickness=0.0066 inch

 **Mini-Circuits®**