



CERAMIC

# Bandpass Filter

## BFHK-7851+

50Ω 6.7 to 8.6 GHz

### THE BIG DEAL

- Ultra-High Stopband Rejection Structure – 80 dB typical
- Surface mountable pick and place standard case style
- Standard small 1812 (4.5mm x 3.2mm) case style
- High quality distributed filter topology
- Wide rejection band
- Shielded construction preventing filter from de-tuning
- Reduced footprint area by employing LGA (land grid array)
- Suited for very high-volume production
- Patent Pending



Generic photo used for illustration purposes only

CASE STYLE: NM1812C-3

#### +RoHS Compliant

The +Suffix identifies RoHS Compliance. See our web site for RoHS Compliance methodologies and qualifications

### APPLICATIONS

- Test and Measurement
- Aerospace and Defense Signal Conditioning

### PRODUCT OVERVIEW

The BFHK-7851+ LTCC Band Pass Filter achieves a miniature size and high repeatability of performance by utilizing a proprietary LTCC material system and distributed filter topology. The passband loss at 6.7 – 8.6 GHz is as low as 3.2 dB, with typical stopband rejections at 80 dB up to 18.5 GHz. This model handles up to 1W RF input power, and provides a wide operating temperature range from -55 to +125°C. Utilizing a proprietary LTCC material system and a distributed filter topology, this filter is able to achieve repeatable performance on a lot-to-lot basis.

### KEY FEATURES

Feature	Advantages
Ultra-High Rejection	Typical stopband rejections at 80 dB up to 18.5 GHz
Cost effective	LTCC is scalable technology that is cost effective due to ease of production in high quantities.
Small size (4.5mm x 3.2mm)	Allows for high layout density of circuit boards, while minimizing effects of parasitics.
Surface Mountable	Suitable for very high volume automated assembly process.

REV. OR  
ECO-010132  
BFHK-7851+  
WY/CP/AM  
211214





CERAMIC

# Bandpass Filter

## BFHK-7851+

### ELECTRICAL SPECIFICATIONS<sup>1</sup> AT 25°C

Parameter	F#	Frequency (GHz)		Min.	Typ.	Max.	Units	
Center Frequency	—	—	—	—	7.6	—	GHz	
Pass Band	Insertion Loss	F1-F2	6.7	8.6	—	3.2	4.2	dB
	Return Loss	F1-F2	6.7	8.6	—	13.0	—	dB
Stop Band, Lower	Insertion Loss	DC-F3	0.1	4.6	70	80	—	dB
Stop Band, Upper	Insertion Loss	F4-F5	10.9	18.5	70	80	—	dB

1. Measured on Mini-Circuits Test Board TB-BFHK-7851+ with feedline losses removed by normalization of S12 and S21 traces to measurements of TB thru-line

### MAXIMUM RATINGS

Parameter	Ratings
Operating Temperature	-55°C to 125°C
Storage Temperature	-55°C to 125°C
RF Power Input	1W max.

Permanent damage may occur if any of these limits are exceeded

### TYPICAL FREQUENCY RESPONSE

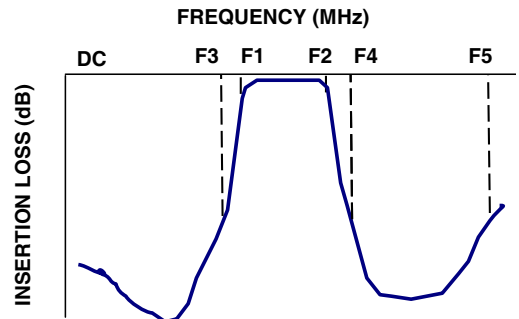

### FUNCTIONAL SCHEMATIC

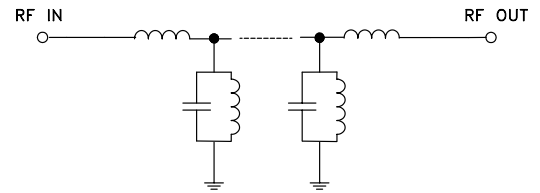



CERAMIC

# Bandpass Filter

# BFHK-7851+

## EVALUATION BOARD MCL P/N: TB-BFHK-7851+ SUGGESTED PCB LAYOUT: PL-714

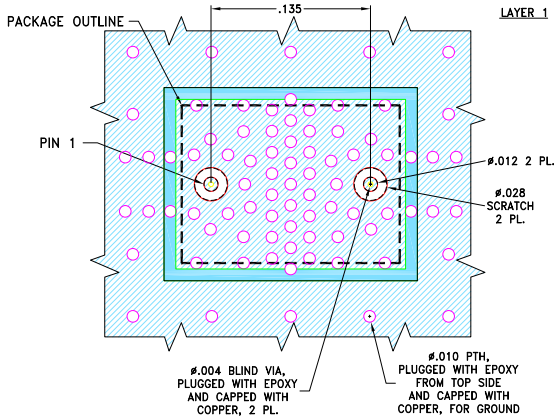

### NOTES:

1. PCB IS MULTILAYER PCB, SEE STACK-UP DIAGRAM.
2. TRACE WIDTH & GAP PARAMETERS ARE SHOWN FOR THE SPECIFIED STACKUP. FOR OTHER STACKUPS AND MATERIALS TRACE WIDTH AND GAP MAY NEED TO BE MODIFIED.
3. LAYER 4 OF THE PCB IS CONTINUOUS GROUND PLANE.

- DENOTES PCB COPPER LAYOUT WITH SMOBC (SOLDER MASK OVER BARE COPPER).
- DENOTES COPPER LAND PATTERN FREE OF SOLDER MASK.

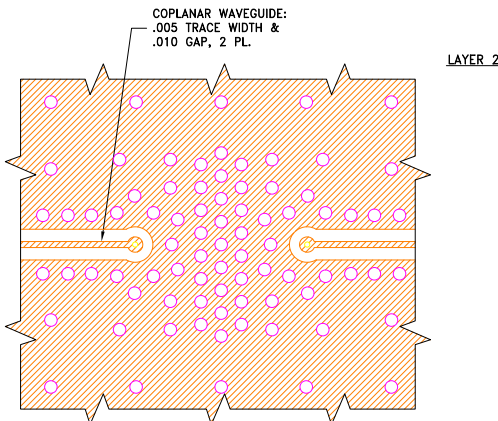

### STACK-UP DIAGRAM

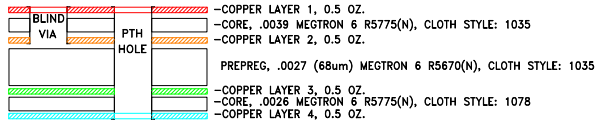

1. TOTAL FINISHED THICKNESS 0.015 ± 10%.
2. PTH PRESENT FROM COPPER LAYER 1 TO 4.
3. BLIND VIAS PRESENT FROM COPPER LAYER 1 TO 2.

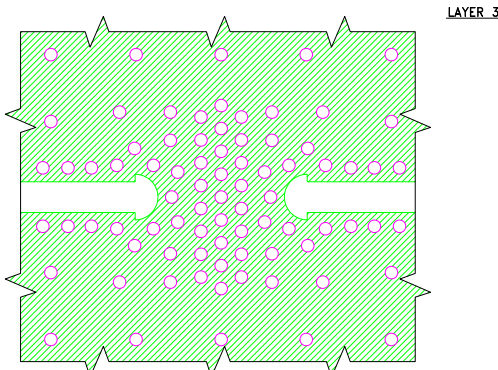

## PAD CONNECTIONS

INPUT	1
OUTPUT	2
GROUND	3

## PRODUCT MARKING: F477

## OUTLINE DRAWING

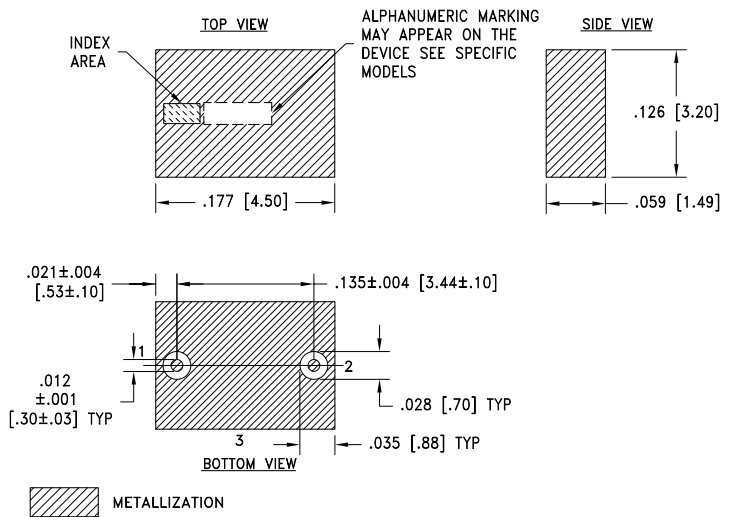

Weight: .126 grams.

Dimensions are in inches [mm]. Tolerances: 2Pl. ±.01; 3Pl. ±.005



CERAMIC

# Bandpass Filter

## BFHK-7851+

### TYPICAL PERFORMANCE DATA

Frequency (MHz)	Insertion Loss (dB)	Return Loss (dB)
100	120.55	0.08
4600	79.86	0.57
6700	2.16	19.51
7600	2.21	16.35
8600	3.12	16.09
11000	81.76	1.73
12000	85.36	1.17
13000	91.87	1.04
14000	92.62	1.19
15000	103.78	1.41
16000	103.25	1.66
17000	103.89	1.59
18000	92.98	1.42
19000	82.49	1.40
20000	72.89	1.66
21000	40.62	7.68
22000	9.09	8.84

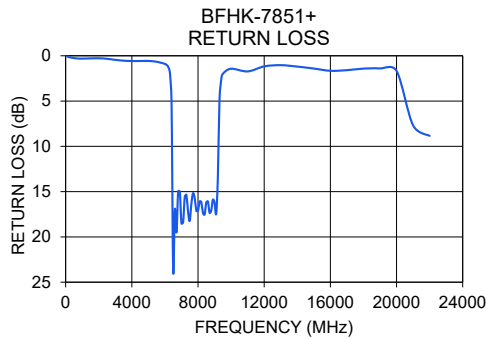
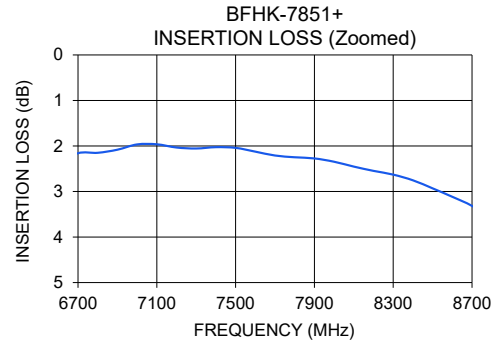
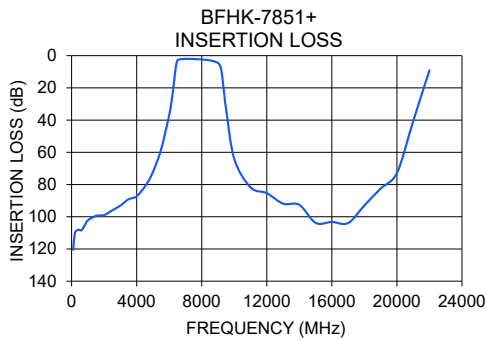

- NOTES**
- A. Performance and quality attributes and conditions not expressly stated in this specification document are intended to be excluded and do not form a part of this specification document.
  - B. Electrical specifications and performance data contained in this specification document are based on Mini-Circuit's applicable established test performance criteria and measurement instructions.
  - C. The parts covered by this specification document are subject to Mini-Circuits standard limited warranty and terms and conditions (collectively, "Standard Terms"); Purchasers of this part are entitled to the rights and benefits contained therein. For a full statement of the standard. Terms and the exclusive rights and remedies thereunder, please visit Mini-Circuits' website at [www.minicircuits.com/MCLStore/terms.jsp](http://www.minicircuits.com/MCLStore/terms.jsp)

