

Surface Mount Digital Step Attenuator

DAT-15R5A+ Series

50Ω 0 to 15.5 dB, 0.5 dB Step DC to 4.0 GHz

The Big Deal

- Wideband, operates up to 4 GHz
- Immune to latchup
- High IP3, 52 dBm



CASE STYLE: DG983-2

Product Overview

The DAT-15R5A+ series of 50Ω digital step attenuators provides adjustable attenuation from 0 to 15.5 dB in 0.5 dB steps. The control is a 5-bit serial/parallel interface, and the attenuators operate with either single positive or dual (positive and negative) supply voltage. DAT-15R5A+ series models are produced by a unique CMOS process on silicon, offering the performance of GaAs with the advantages of conventional CMOS devices.

Key Features

Feature	Advantages
Wideband operation, specified from DC to 4.0 GHz	Can be used in multiple applications such as communications, satellite and defense, reducing part count.
Serial or parallel interface	Models available with serial or parallel interface mode to suit customer demand.
Good VSWR, 1.2:1 typ.	Eases interfacing with adjacent components and results in low amplitude ripple.
Single positive supply models: (Model suffixes: -SN+ and -PN+) +2.3 to +3.6V	Use of single positive supply simplifies power supply design. An internal negative voltage generator supplies the desired negative voltage. Single positive supply results in excellent spurious performance, -140 dBm typical.
Dual supply models: (Model suffixes: -SN and -PN) +2.7 to +3.6V (Positive) and -3.6 to -3.2V (Negative)	Dual supply provides spurious-free operation. It also allows fast switching up to 1 MHz (vs. 25 kHz for single supply).
Useable over a wide range of supply voltages, +2.3/2.7 to 5.2V	Wide range of positive operating voltages allows the DAT-15R5A+ Series of models to be used in a wide range of applications. See Application Note AN-70-006 for operation above +3.6V
Footprint compatible to DAT-15R5-XX+ Series (XX=SN/SP/PN/PP)	Can fit into existing footprint and provide improved performance.
Safe attenuation transitions	The DAT-15R5A-XX+ series is designed to prevent any momentary positive 'spikes' in power during attenuation transitions



Digital Step Attenuator

50Ω DC-4000 MHz

15.5 dB, 0.5 dB Step

5 Bit, Serial control interface, Dual Supply Voltage

Product Features

- Immune to latch up
- Excellent accuracy, 0.1 dB Typ
- Serial control interface
- Fast switching control frequency, up to 1 MHz typ.
- Low Insertion Loss
- High IP3, +52 dBm Typ
- Very low DC power consumption
- Excellent return loss, 20 dB Typ
- Small size 4.0 x 4.0 mm



Generic photo used for illustration purposes only

DAT-15R5A-SN+

CASE STYLE: DG983-2

+RoHS Compliant

The +Suffix identifies RoHS Compliance. See our web site for RoHS Compliance methodologies and qualifications

Typical Applications

- Base Station Infrastructure
- Portable Wireless
- CATV & DBS
- MMDS & Wireless LAN
- Wireless Local Loop
- UNII & Hiper LAN
- Power amplifier distortion canceling loops

General Description

The DAT-15R5A+ series of 50Ω digital step attenuators provides adjustable attenuation of 0 to 15.5 dB in 0.5 dB steps. The control is a 5-bit serial interface, and the attenuator operates with dual (positive and negative) supply voltage. DAT-15R5A-SN+ is produced using a CMOS process on silicon, offering the performance of GaAs with the advantages of conventional CMOS devices.

Simplified Schematic

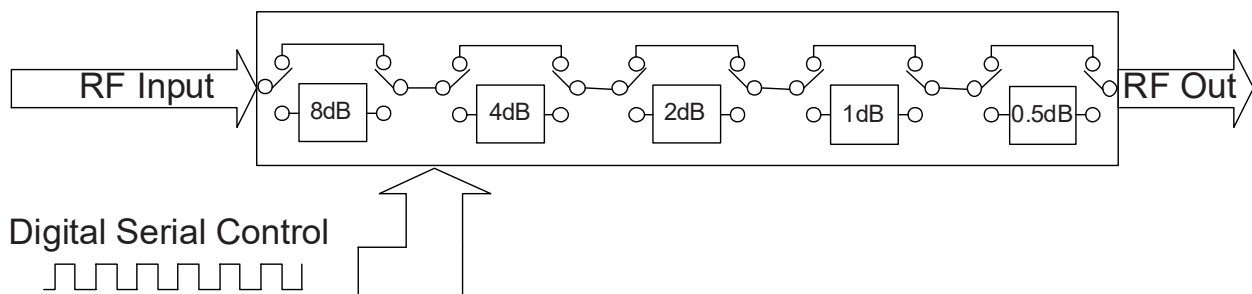

RF Electrical Specifications ^(Note1), DC-4000 MHz, $T_{AMB}=25^{\circ}C$, $V_{DD}=+3V$, $V_{SS}=-3.2V$

Parameter	Freq. Range (GHz)	Min.	Typ.	Max.	Units
Accuracy @ 0.5 dB Attenuation Setting	DC-1	—	0.03	0.1	dB
	1-2.4	—	0.05	0.15	
	2.4-4	—	0.07	0.2	
Accuracy @ 1 dB Attenuation Setting	DC-1	—	0.02	0.1	dB
	1-2.4	—	0.05	0.15	
	2.4-4	—	0.1	0.25	
Accuracy @ 2 dB Attenuation Setting	DC-1	—	0.05	0.15	dB
	1-2.4	—	0.15	0.25	
	2.4-4	—	0.15	0.35	
Accuracy @ 4 dB Attenuation Setting	DC-1	—	0.07	0.2	dB
	1-2.4	—	0.15	0.25	
	2.4-4	—	0.23	0.5	
Accuracy @ 8 dB Attenuation Setting	DC-1	—	0.03	0.2	dB
	1-2.4	—	0.15	0.5	
	2.4-4	—	0.6	0.8	
Insertion Loss ^(note 1) @ all attenuator set to 0dB	DC-1	—	1.3	1.9	dB
	1-2.4	—	1.6	2.4	
	2.4-4	—	2.1	3.0	
Input IP3 ^(note 2) (at Min. and Max. Attenuation)	DC-4	—	+52	—	dBm
Input Power @ 0.2dB Compression ^(note 2) (at Min. and Max. Attenuation)	DC-4	—	+24	—	dBm
Input Operating Power	10 kHz to 50 MHz	—	—	See Fig. 1	dBm
	>50 MHz	—	—	+24	
VSWR	DC-1	—	1.2	1.5	:1
	1-2.4	—	1.2	1.6	
	2.4-4	—	1.4	1.9	

Notes:

1. Tested on Evaluation Board TB-342. See Figure 3.
2. Insertion loss values are de-embedded from test board Loss (test board's Insertion Loss: 0.10dB @ 100MHz, 0.35dB @ 1000MHz, 0.60dB @ 2400MHz, 0.75dB @ 4000MHz).
3. Input IP3 and 1dB compression degrade below 1 MHz. Input power not to exceed max operating specification for continuous operation.

DC Electrical Specifications

Parameter	Min.	Typ.	Max.	Units
V_{DD} , Supply Voltage	2.7	3	3.6 ^(Note 4)	V
V_{SS} , Supply Voltage	-3.6	-3.3	-3.2	V
I_{DD} Supply Current	—	—	100	μA
I_{SS} Supply Current	—	16	40	μA
Control Input Low	-0.3	—	+0.6	V
Control Input High	1.17	—	3.6	V
Control Current	—	—	20 ^(Note 5)	μA

4. For operation above +3.6V, see Application Note AN-70-006

5. Except, 30 μA typ for C0.5 at +3.6V

Absolute Maximum Ratings ^(Note 6,7)

Parameter	Ratings
Operating Temperature	-40°C to 105°C
Storage Temperature	-65°C to 150°C
V_{DD}	-0.3V Min., 5.5V Max.
V_{SS}	-3.6V Min., 0.3V Max.
Voltage on any control input	-0.3V Min., 3.6V Max.
Input Power	+30dBm
Thermal Resistance	37°C/W

6. Permanent damage may occur if any of these limits are exceeded.

7. Operation between max operating and absolute max input power will result in reduced reliability.

Switching Specifications

Parameter	Min.	Typ.	Max.	Units
Switching Speed, 50% Control to 0.5dB of Attenuation Value	—	1.0	—	μSec
Switching Control Frequency	—	1.0	—	MHz

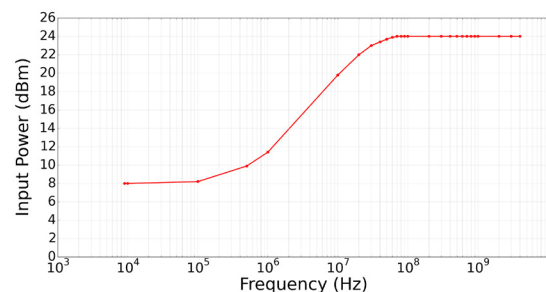

Figure 1. Max Input Operating Power vs Frequency

Digital Step Attenuator

DAT-15R5A-SN+

Pin Description

Function	Pin Number	Description
N/C	1	Not connected (Note 7)
RF in	2	RF in port (Note 1)
Data	3	Serial Interface data input (Note 3)
Clock	4	Serial Interface clock input
LE	5	Latch Enable Input (Note 2)
V _{DD}	6	Positive Supply Voltage
N/C	7	Not connected
N/C	8	Not connected
V _{DD}	9	Positive Supply Voltage
GND	10	Ground connection
GND	11	Ground connection
V _{SS}	12	Negative Supply Voltage
V _{DD}	13	Positive Supply Voltage (Note 8)
RF out	14	RF out port (Note 1)
C8	15	Control for attenuation bit, 8 dB (Note 4)
C4	16	Control for attenuation bit, 4 dB (Note 4)
C2	17	Control for attenuation bit, 2 dB (Note 4)
GND	18	Ground Connection
C1	19	Control for attenuation bit, 1 dB (Note 4)
C0.5	20	Control for attenuation bit, 0.5 dB (Note 4)
GND	Paddle	Paddle ground (Note 5)

Pin Configuration (Top View)

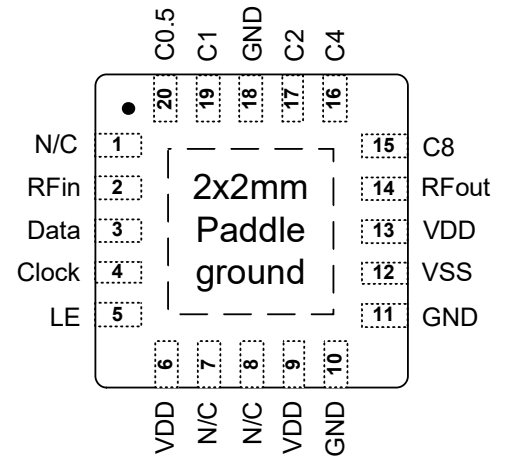

Device Marking

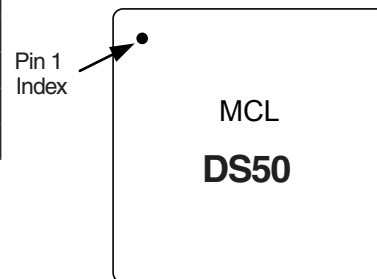

Notes:

- Both RF ports must be held at 0VDC or DC blocked with an external series capacitor.
- Latch Enable (LE) has an internal 2MΩ to internal positive supply voltage.
- Place a 10KΩ resistor in series, as close to pin as possible to avoid freq. resonance.
- Refer to Power-up Control Settings.
- The exposed solder pad on the bottom of the package (See Pin configuration) must be grounded for proper device operation.
- This pin has an internal 200 kΩ resistor to ground.
- Place a shunt 10 kΩ resistor to ground.
- When $V_{DD} \leq 3.6V$ this pin may be connected directly to VDD, when $3.6V < V_{DD} \leq 5.2V$ need to use a voltage divider to reduce voltage on this pin to a voltage in the range +1.17 to 3.6V. See Application note AN-70-006.

Simplified Schematic

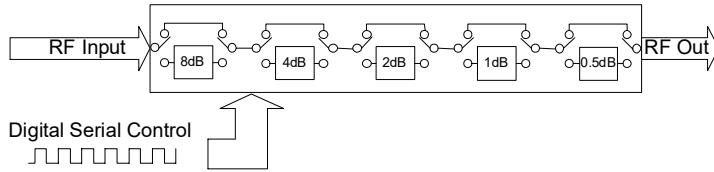

The DAT-15R5A-SN+ serial interface consists of 5 control bits that select the desired attenuation state, as shown in Table 1: Truth Table

Table 1. Truth Table					
Attenuation State	C8	C4	C2	C1	C0.5
Reference	0	0	0	0	0
0.5 (dB)	0	0	0	0	1
1 (dB)	0	0	0	1	0
2 (dB)	0	0	1	0	0
4 (dB)	0	1	0	0	0
8 (dB)	1	0	0	0	0
15.5 (dB)	1	1	1	1	1

Note: Not all 32 possible combinations of C0.5 - C8 are shown in table

The serial interface is a 5-bit serial in, parallel-out shift register buffered by a transparent latch. It is controlled by three CMOS-compatible signals: Data, Clock, and Latch Enable (LE). The Data and Clock inputs allow data to be serially entered into the shift register, a process that is independent of the state of the LE input.

The LE input controls the latch. When LE is HIGH, the latch is transparent and the contents of the serial shift register control the attenuator. When LE is brought LOW, data in the shift register is latched.

The shift register should be loaded while LE is held LOW to prevent the attenuator value from changing as data is entered. The LE input should then be toggled HIGH and brought LOW again, latching the new data. The timing for this operation is defined by **Figure 2** (Serial Interface Timing Diagram) and **Table 2** (Serial Interface AC Characteristics).

Figure 2: Serial interface Timing Diagram

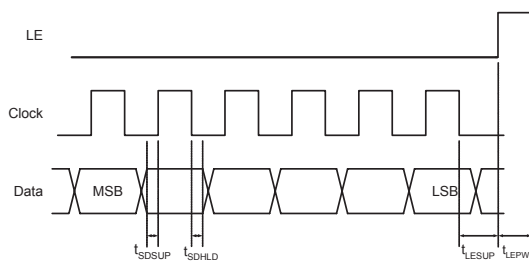

Table 2. Serial Interface AC Characteristics

Symbol	Parameter	Min.	Max.	Units
f_{clk}	Serial data clock frequency (Note 1)		10	MHz
t_{clkH}	Serial clock HIGH time	30		ns
t_{clkL}	Serial clock LOW time	30		ns
t_{LESUP}	LE set-up time after last clock falling edge	10		ns
t_{LEPW}	LE minimum pulse width	30		ns
t_{SDSUP}	Serial data set-up time before clock rising edge	10		ns
t_{SDHLD}	Serial data hold time after clock falling edge	10		ns

Note 1. f_{clk} verified during the functional pattern test. Serial programming sections of the functional pattern are clocked at 10MHz to verify f_{clk} specification.

The DAT-15R5A-SN+, uses a common 5-bit serial word format, as shown in **Table 3**: 5-Bit attenuator Serial Programming Register Map.

The B4 bit corresponds to the 8 dB Step and the bit B0 corresponds to the 0.5 dB step.

B5	B4	B3	B2	B1	B0
0	C8	C4	C2	C1	C0.5

↑
↑
 MSB (first in)
 LSB (last in)

Note: The start bit (B5) must always be low(0) to prevent the attenuator from entering an unknown state.

Power-up Control Settings

The DAT-15R5A-SN+ always assumes a specifiable attenuation setting on power-up, allowing a known attenuation state to be established before an initial serial control word is provided.

When the attenuator powers up, the five control bits are set to whatever data is present on the five data inputs (C0.5 to C8).

This allows any one of the 32 attenuation settings to be specified as the power-up state.

Digital Step Attenuator

DAT-15R5A-SN+

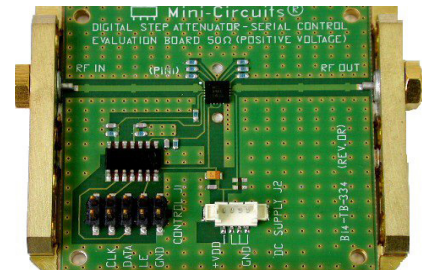
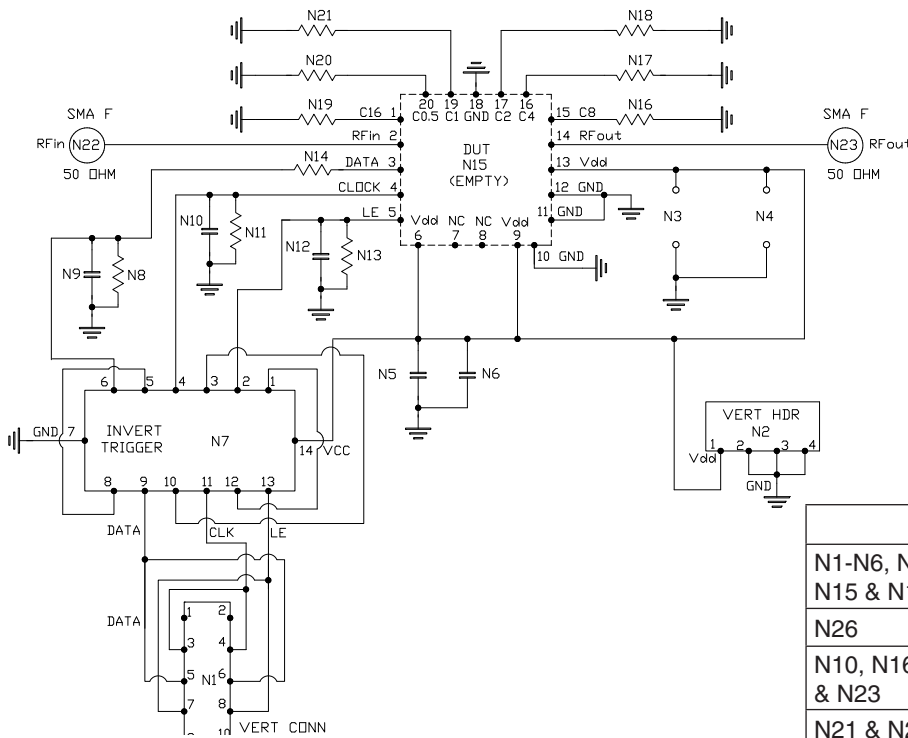

TB-342

Bill of Materials	
N1-N6, N11, N12, N15 & N18	Resistor 0603 10 KOhm +/- 1%
N26	Resistor 0603 0 Ohm
N10, N16, N17, N20 & N23	NPO Capacitor 0603 100pF +/- 5%
N21 & N22	Tantalum Capacitor 0805 100nF +/- 10%
N19	Hex Invert Schmitt Trigger MSL1

Notes

1. Both RF ports must be held at 0VDC or DC blocked with an external series capacitor.
2. Test Board TB-342 is designed for operation for VDD=2.3 to 3.6V. For operation over 3.6V to 5.2V, See Application Note AN-70-006
3. VDD=Vdd

Fig 3. Evaluation Board Schematic, TB-342, used for characterization (DUT not soldered on TB-342)

Test Equipment

For Insertion Loss, Isolation and Return Loss:

Agilent's E5071C Network Analyzer & E3631A Power Supply.

For Compression:

Agilent's N9020A Signal Analyzer, E8247C RF Generator, E3631A Power Supply & U2004A Power Sensor.

For Input IP3:

Agilent's N9020A Signal Analyzer, N5181A Signal Generators, E3631A Power Supply, U2004A Power Sensor.

For Spurs:

Agilent N5181A Signal Generator, E4440A Spectrum Analyzer.

For Switching Time:

Agilent's N5181A Signal Generator, 81110A Pulse Generator, 54832B Oscilloscope, E3631A Power Supply.

For Max Control Frequency:

Agilent's N5181A Signal Generator, N9020A Signal Analyzer, E3631A Power Supply, 81110A Pulse Generator.

Measurement Conditions

For Insertion Loss, Isolation and Return Loss:

VDD=+2.7/+3/+5.5V & Pin=0dBm

VSS=-3.2/-3.6V

For Compression:

Pin=0/+24dBm. VDD=+3V, VSS=-3V

For Input IP3:

Pin=+10dBm/tone. Tone spacing: 0.1 MHz to 1 MHz RF Freq and 1 MHz to 4200 MHz RF Freq, VDD=+3V, VSS=-3V

For Spurs:

RF IN at 1000MHz and -20dBm. VDD=+3V

For Switching Time:

RF Freq=501MHz/0dBm, Pulse for LE=1Hz/0/+3.4V, Delay=500ms, Width=500ms. VDD=+3V & VSS=-3V

For Max Control Frequency:

RF Freq=501MHz, 0dBm. VDD=+3V, VSS=-3V



Additional Detailed Technical Information	
<i>additional information is available on our dash board. To access this information click here</i>	
Performance Data	Data Table
	Swept Graphs
	S-Parameter (S2P Files) Data Set (.zip file)
Case Style	DG983-2 <i>Plastic package, exposed paddle, lead finish: NiPdAu</i>
Tape & Reel Standard quantities available on reel	F87 <i>7" reels with 20, 50, 100 or 200 devices</i> <i>13" reels with 3K devices</i>
Suggested Layout for PCB Design	PL-198
Evaluation Board	TB-342
Environmental Ratings	ENV33T1

ESD Rating

Human Body Model (HBM): Class 1C (1000 to <2000V) in accordance with MIL-STD-883 method 3015

MSL Rating

Moisture Sensitivity: MSL1 in accordance with IPC/JEDEC J-STD-020D

MSL Test Flow Chart



Additional Notes

- Performance and quality attributes and conditions not expressly stated in this specification document are intended to be excluded and do not form a part of this specification document.
- Electrical specifications and performance data contained in this specification document are based on Mini-Circuit's applicable established test performance criteria and measurement instructions.
- The parts covered by this specification document are subject to Mini-Circuits standard limited warranty and terms and conditions (collectively, "Standard Terms"); Purchasers of this part are entitled to the rights and benefits contained therein. For a full statement of the Standard Terms and the exclusive rights and remedies thereunder, please visit Mini-Circuits' website at www.minicircuits.com/MCLStore/terms.jsp