



## USB & DAISY CHAIN

# SPDT Solid-State Switch Module

# eSB-1SP2T-A673

Mini-Circuits

50Ω

0.1 to 67 GHz

Absorptive Switch

1.85 mm female

### THE BIG DEAL

- Super wide bandwidth, solid-state design
- High isolation, absorptive switch
- USB control and automation
- Daisy-chain control of up to 25 modules
- LED indicator on active port

### APPLICATIONS

- RF & millimeter wave signal routing / switch matrices
- Satellite communications up to V band
- Military radio, radar & electronic warfare
- Microwave radio / cellular infrastructure
- Test & measurement systems



Generic photo used for illustration purposes only

### PRODUCT OVERVIEW

Mini-Circuits' eSB-1SP2T-A673 is a fast switching absorptive SPDT covering an ultra-wide bandwidth, from 0.1 to 67 GHz. The solid-state design features an impressive combination of high isolation, low insertion loss and good linearity across the entire band, with internal terminations on ports RF1 to RF2.

The switch is supplied in a low profile package (3.5" x 0.984" x 0.925") with 3 precision 1.85 mm (F) RF connectors, a USB type C port for power and control, and two data bus connectors for Master / Slave connections to other modules. LED indicators on the switch package provide a convenient indicator of the current switch state.

Full software support is provided, including our user-friendly GUI application for Windows and a full API with programming instructions for Windows and Linux environments (both 32-bit and 64-bit systems).

### KEY FEATURES

Feature	Advantages
Fast switching sequences	Program automated switching sequences to run with extremely fast transitions and no external control.
High performance	Solid-state design combining high isolation with low insertion loss from 0.1 to 67 GHz.
Dynamic daisy-chain control	Control up to 25 switches through a single USB interface.
USB control	USB HID interface provides easy compatibility with a wide range of software setups and programming environments.
Full software support	User friendly Windows GUI (graphical user interface) allows manual control straight out of the box, while the comprehensive API (application programming interface) with examples and instructions allows easy automation in most programming environments.

#### Trademarks:

Windows is a registered trademark of Microsoft Corporation in the United States and other countries ; Linux is a registered trademark of Linus Torvalds ; Pentium is a registered trademark of Intel Corporation. Neither Mini-Circuits nor the Mini-Circuits products are affiliated with or endorsed by the owners of the referenced trademarks. Mini-Circuits and the Mini-Circuits logo are registered trademarks of Scientific Components Corporation.





**ELECTRICAL SPECIFICATIONS AT 0 TO 50°C**

Parameter	Ports	Condition (GHz)	Min.	Typ.	Max.	Unit
Frequency range	-	-	0.1		67	MHz
Insertion loss	COM to any active port	0.1 - 18	-	2.0	3.5	dB
		18 - 40	-	3.0	4.5	
		40 - 63	-	5.0	7.0	
		63 - 67	-	7.0	-	
Isolation	Between ports RF1 to RF2	0.1 - 18	40	60	-	dB
		18 - 40	40	48	-	
		40 - 63	35	45	-	
		63 - 67	-	40	-	
	COM to any terminated port (including disconnected state)	0.1 - 18	40	55	-	
		18 - 40	35	45	-	
		40 - 63	33	42	-	
		63 - 67	-	40	-	
Return loss	COM port (in all active states)	0.1 - 18	-	17	-	dB
		18 - 40	-	15	-	
		40 - 63	-	9	-	
		63 - 67	-	7	-	
	Any port connected to COM	0.1 - 18	-	17	-	
		18 - 40	-	15	-	
		40 - 63	-	11	-	
		63 - 67	-	8	-	
	Any terminated port	0.1 - 18	-	20	-	
		18 - 40	-	13	-	
		40 - 63	-	10	-	
		63 - 67	-	8	-	
Power input @1 dB compression	COM to any active port	0.1 - 67	-	+28	-	dBm
IP3	COM to any active port	0.1 - 67	-	+50	-	dBm
Transition time <sup>1</sup>	-	-	-	600	-	ns
Minimum dwell time <sup>2</sup>	High-speed mode	-	-	20	-	μs
Switching time (USB) <sup>3</sup>	-	-	-	2	-	ms

1. Transition time spec represents the time that the RF signal paths are interrupted during switching and thus is specified without communication delays.

2. Minimum dwell time is the shortest time that can be achieved between 2 switch transitions when programming an automated switch sequence.

3. Switching time (USB) is the time from issuing a single software command via USB to the switch state changing. The most significant factor is the host PC, influenced by CPU load and USB protocol. The time shown is an estimate for a medium CPU load and USB 2.0 connection.



## USB & DAISY CHAIN

# SPDT Solid-State Switch Module

# eSB-1SP2T-A673



50Ω

0.1 to 67 GHz

Absorptive Switch

1.85 mm female

### ELECTRICAL SPECIFICATIONS AT 0 TO 50°C (CONTINUED)

Parameter	Ports	Condition (GHz)	Min.	Typ.	Max.	Unit
Supply voltage (Vcc)	USB port	-	4.75	5	5.25	V <sub>DC</sub>
Supply current (Icc) <sup>4</sup>		-	-	80	120	mA
Current pass-through <sup>5</sup>		-	-	-	-	500
Operating RF input power	Through path (Hot & Cold switching)	0.1 - 0.3	-	-	+24	dBm
		0.3 - 40	-	-	+26	
		40 - 67	-	-	+24	
	Into termination	0.1 - 0.3	-	-	+22	
		0.3 - 40	-	-	+24	
		40 - 67	-	-	+22	

4. USB current draw for a single unit with no slave units.

5. Pass-through current is the maximum supply current handling of a unit with slave modules attached. If controlling a large number of slave modules additional power supplies should be included to ensure this limit is not exceeded.

### ABSOLUTE MAXIMUM RATINGS <sup>6</sup>

Operating temperature	0°C to 50°C
Storage temperature	-20°C to 60°C
DC supply voltage max @ USB and pin 4 of D-sub	6V
DC voltage @ RF ports	0V

6. Permanent damage may occur if any of these limits are exceeded. Operating in the range between operating power limits and absolute maximum ratings for extended periods of time may result in reduced life and reliability.





TYPICAL PERFORMANCE GRAPHS

Insertion Loss over Temperature (RF1 Active)

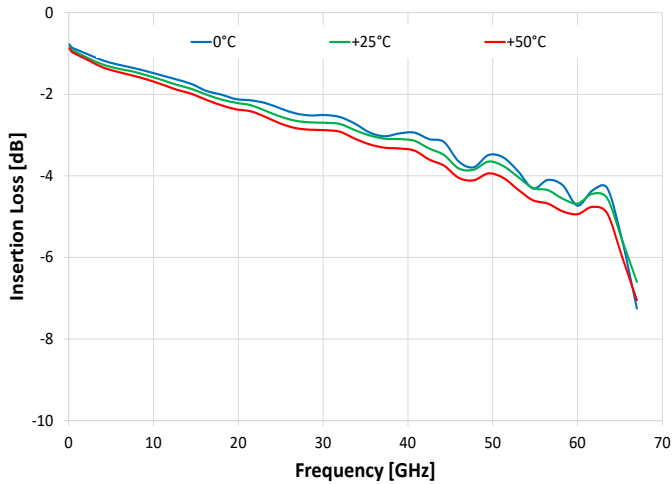

Insertion Loss RF1 - RF2 Active

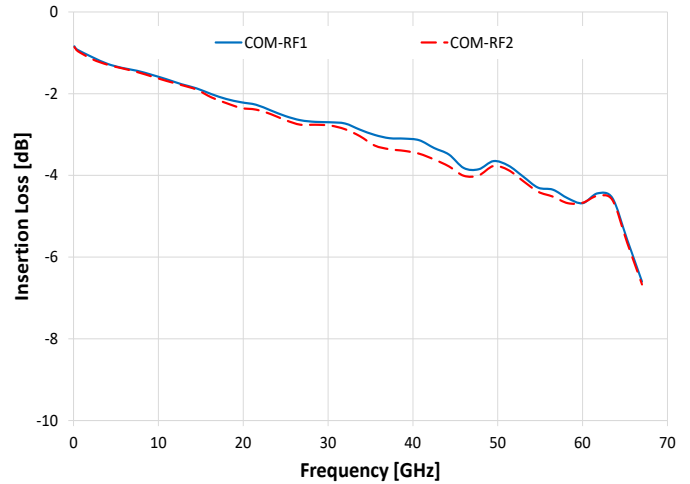

Isolation Com to RF1 (RF2 Active)

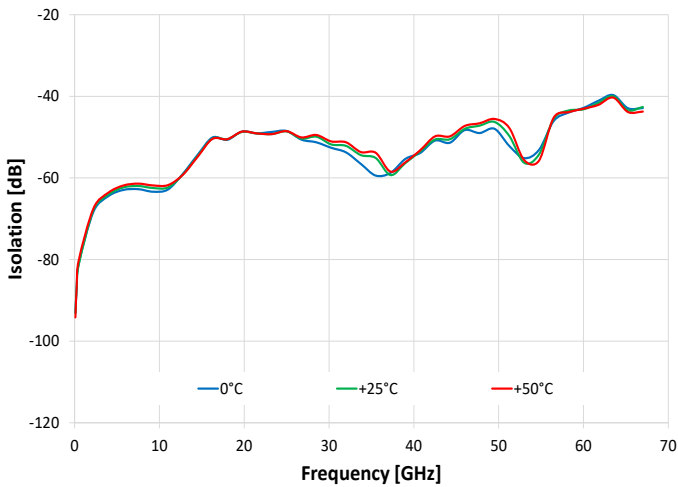

Isolation Com to RF2 (RF1 Active)

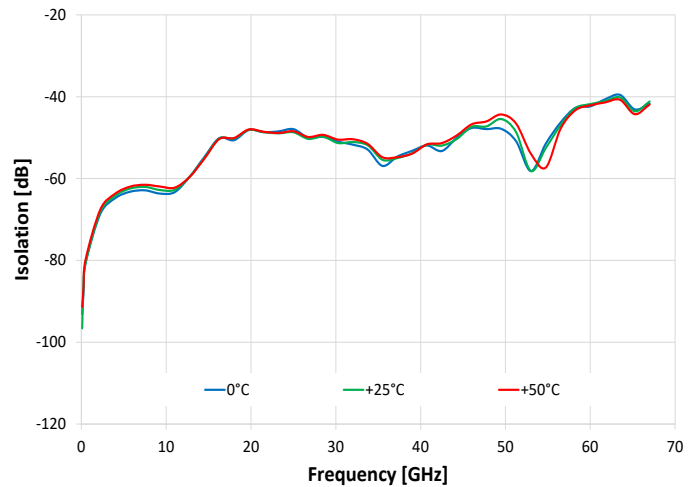

Isolation RF1 to RF2 (RF1 Active)

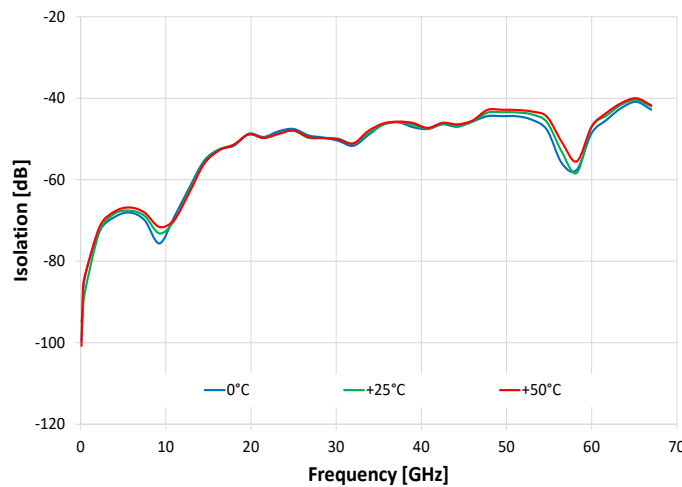



TYPICAL PERFORMANCE GRAPHS (CONTINUED)

Return Loss @ COM over Temperature (RF1 Active)

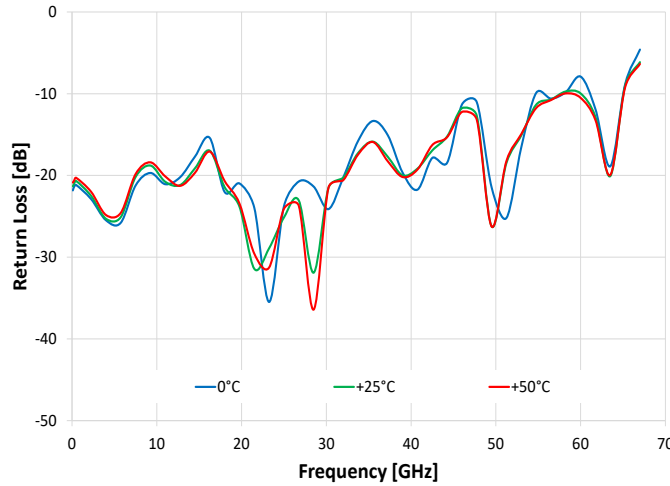

Return Loss @ RF1 over Temperature (RF1 Active)

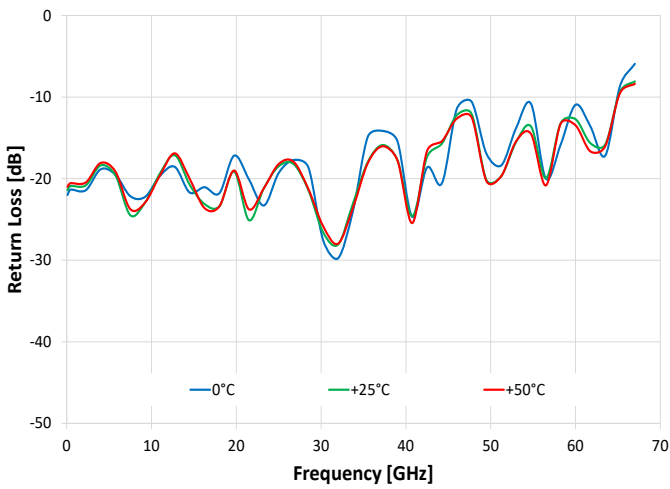

Return Loss @ RF1 over Temperature (RF1 Terminated)

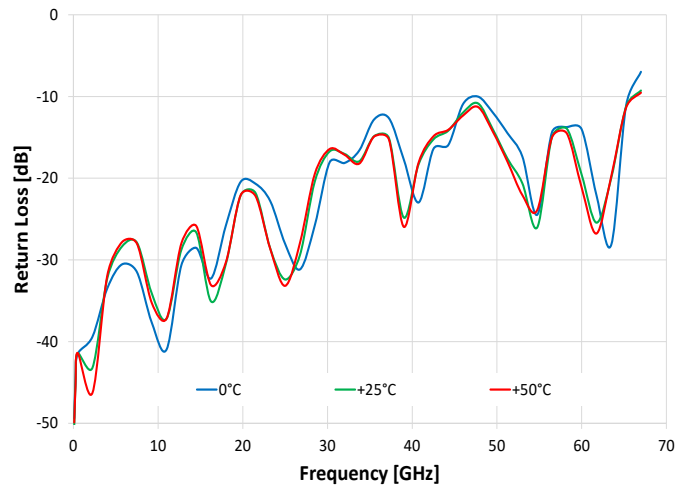

Return Loss @ RF2 over Temperature (RF2 Active)

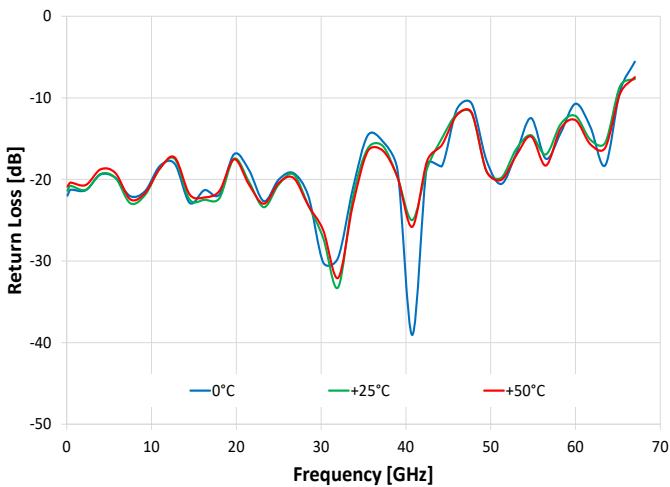

Return Loss @ RF2 over Temperature (RF2 Terminated)

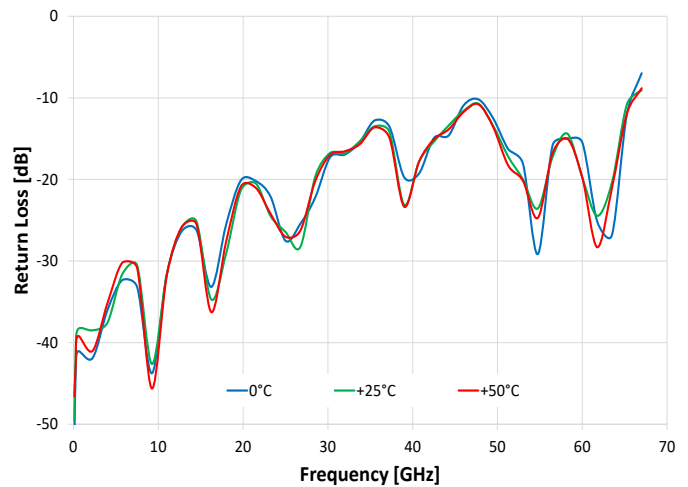



CONTROL INTERFACES

USB control	Supported protocols	HID (Human Interface Device) - Full-speed
	Min communication time <sup>7</sup>	3 ms typ (full transmit/receive cycle)

7. USB min communication time is based on the polling interval of the USB HID protocol (1 ms polling interval, 64 bytes per packet), medium CPU load and no other high speed USB devices using the USB bus.

SOFTWARE & DOCUMENTATION

Mini-Circuits' full software and support package including user guide, Windows GUI, API, programming manual and examples can be downloaded free of charge (refer to the last page for the download path).

A comprehensive set of software control options is provided:

- GUI for Windows – Simple software interface for control via Ethernet and USB.
- Programming / automation via USB:
  - DLL files provide a full API for Windows with a set of intuitive functions which can be implemented in any programming environment supporting .Net Framework or ActiveX.
  - Direct USB programming is possible in any other environment (not supporting .Net or ActiveX).

Please contact [testsolutions@minicircuits.com](mailto:testsolutions@minicircuits.com) for support.

MINIMUM SYSTEM REQUIREMENTS

GUI	Windows 7 or later
USB API DLL	Windows 7 or later and programming environment with ActiveX or .NET support
USB Direct Programming	Linux, Windows 7 or later
Daisy-chain dynamic addressing	An additional Mini-Circuits model supporting dynamic addressing
Hardware	Intel i3 (or equivalent) or later



GRAPHICAL USER INTERFACE (GUI) FOR WINDOWS - KEY FEATURES

- Connect via USB
- Run GUI in "demo mode" to evaluate software without a hardware connection

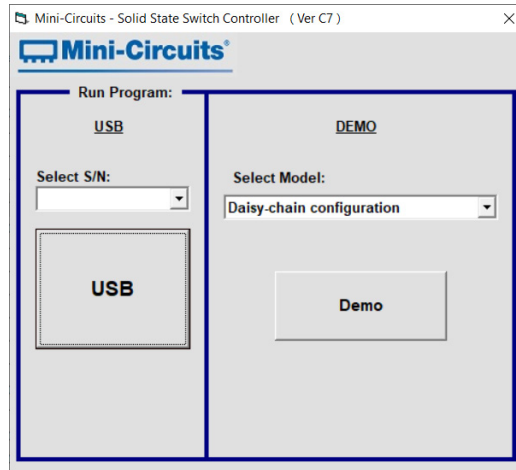

- View and set switch states at the click of a button
- Configure and run timed switching sequences

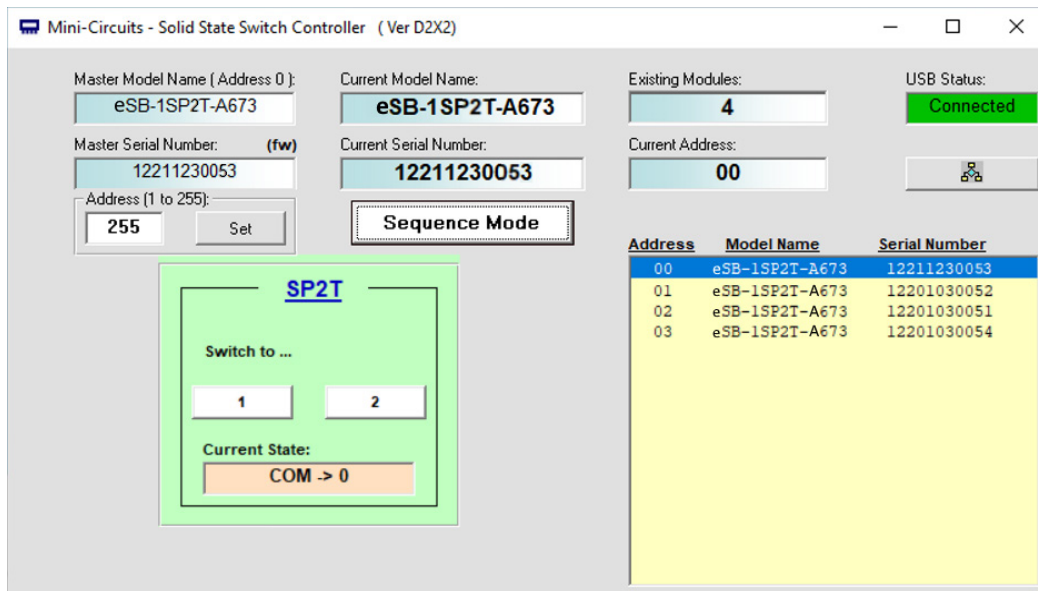



CONNECTING MULTIPLE MODULES (DAISY CHAIN)

The model is designed to connect up to 25 modules in series (daisy chain) using dynamic addressing, meaning there is no need to specifically set the address of the modules. The addresses will be set automatically as part of establishing the communications with the computer. The module connected to the computer's USB port will be assigned address 0 (master), the first module connected to it will get address 1 (slave) and subsequent modules incrementing up to address 24 (slave).

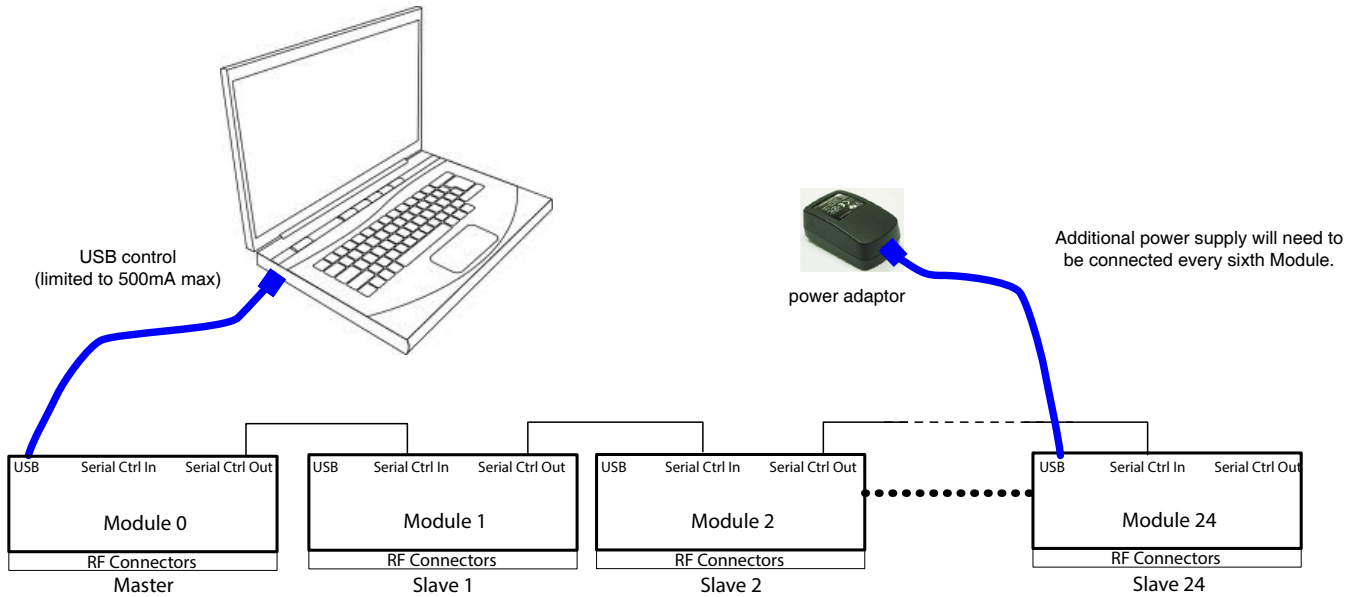

Connections between modules will be made using the serial in/out ports with the module connected to the PC act as a master and all other as slave modules. All control will be through the master module (address 0) which is the only one communicating with the PC. Serial control out port of each module should be connected to the serial control in port of the next module.

Power will be supplied from the PC via the master module up to a maximum of 500 mA. Generally, additional power supply will be needed to keep total current below 500 mA. All power supplies should be connected to the module via the module's USB port. Connecting an additional power supply will automatically cut off power draw from the serial control in port for that module.

The serial master/slave bus allows connecting modules of different types to the same daisy chain as long as all support Mini-Circuits Dynamic addressing setup. To add a new module to the setup, simply connect the module and refresh the address listing, no need to reset any of the existing modules or assign addresses manually.

**Note:** Different module types may have different current consumption which will change the number of units which can be connected before an additional power supply is needed. For example, if connecting units with a current consumption of 100 mA each, additional power supply is recommended every sixth module. If using units with current consumption of 50 mA additional power supply is recommended every eleventh module.





BLOCK DIAGRAM

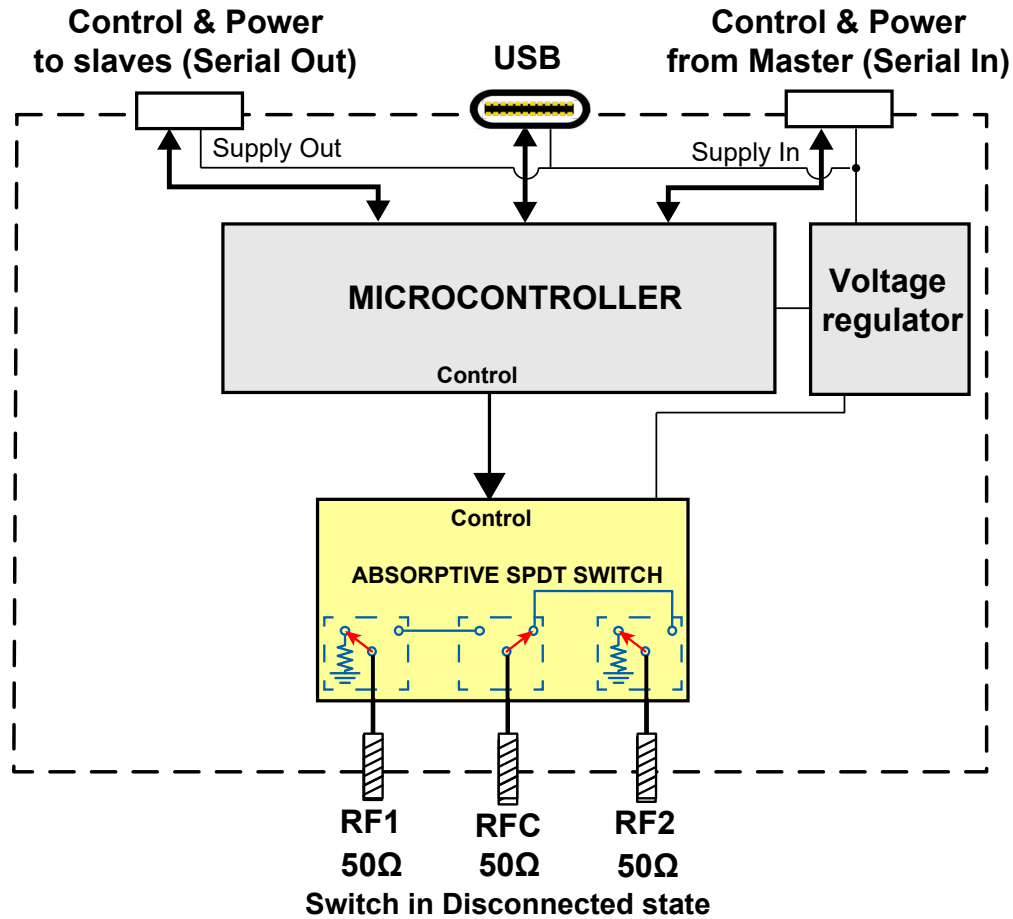

SWITCH STATE TABLE

State	Switch path
0	All ports disconnected
1	Com to RF1
2	Com to RF2

CONNECTIONS

Port name	Connector type
RF Ports (COM, RF1 and RF2)	1.85 mm female
USB	USB type C receptacle
Serial in (digital control 2 port)	Digital snap fit connector <sup>8</sup>
Serial out (digital control 1 port)	Digital snap fit connector <sup>8</sup>

8. Mating connector is Hirose ST40X-10S-CV(30).



# USB & DAISY CHAIN

## SPDT Solid-State Switch Module

## eSB-1SP2T-A673

Mini-Circuits

50Ω

0.1 to 67 GHz

Absorptive Switch

1.85 mm female

### CASE STYLE DRAWING (WP3211)

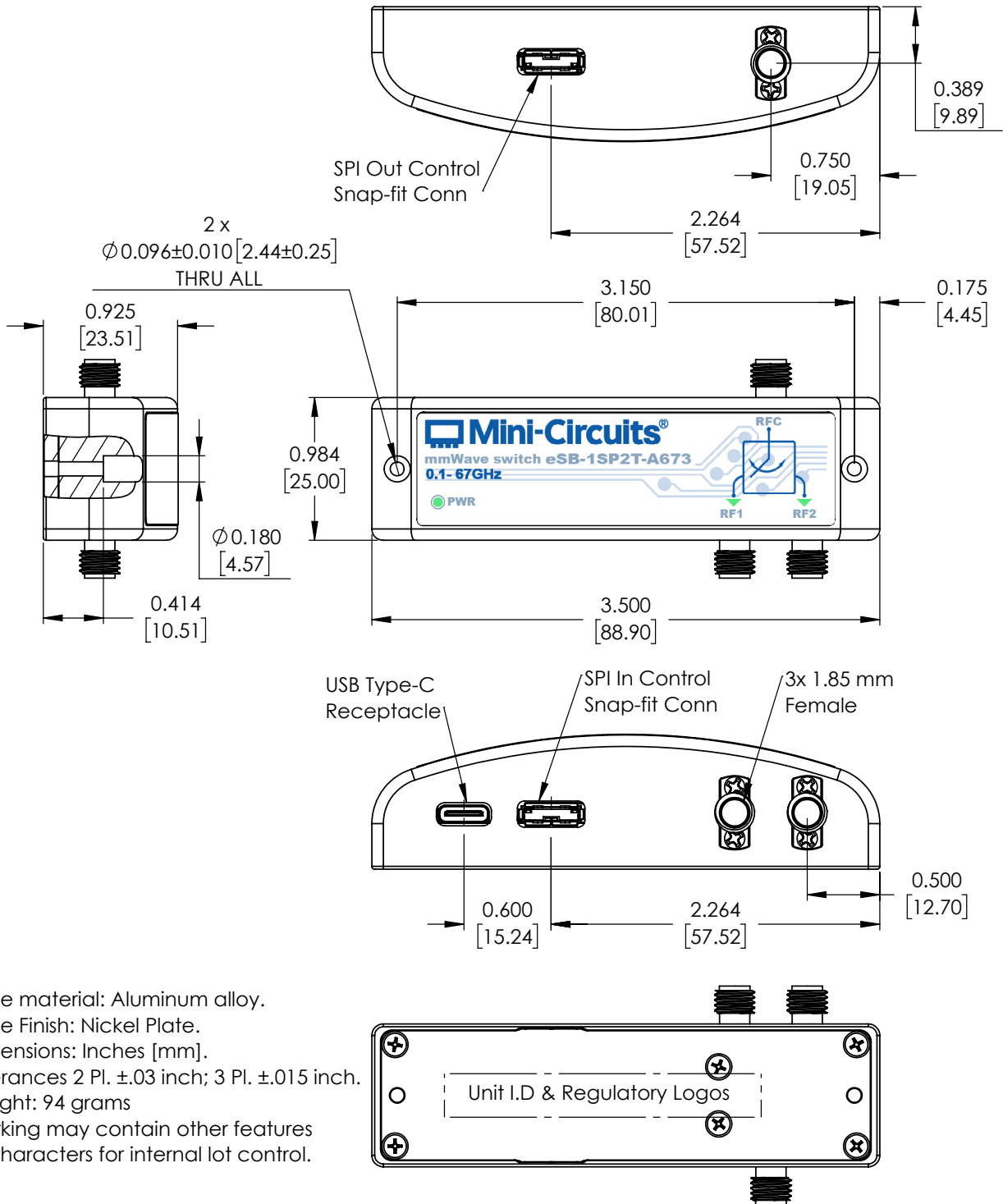

#### NOTES:

1. Case material: Aluminum alloy.
2. Case Finish: Nickel Plate.
3. Dimensions: Inches [mm].  
Tolerances 2 Pl.  $\pm 0.03$  inch; 3 Pl.  $\pm 0.015$  inch.
4. Weight: 94 grams
5. Marking may contain other features or characters for internal lot control.



## USB & DAISY CHAIN

# SPDT Solid-State Switch Module

# eSB-1SP2T-A673

Mini-Circuits

50Ω

0.1 to 67 GHz

Absorptive Switch

1.85 mm female

### ADDITIONAL DETAILED MODEL INFORMATION IS AVAILABLE ON OUR WEBSITE

Ordering information	<a href="https://www.minicircuits.com/WebStore/dashboard.html?model=eSB-1SP2T-A673">https://www.minicircuits.com/WebStore/dashboard.html?model=eSB-1SP2T-A673</a>
Performance data & graphs	<a href="https://www.minicircuits.com/pages/s-params/eSB-1SP2T-A673_VIEW.pdf">https://www.minicircuits.com/pages/s-params/eSB-1SP2T-A673_VIEW.pdf</a> <a href="https://www.minicircuits.com/pages/s-params/eSB-1SP2T-A673_GRAPHPS.pdf">https://www.minicircuits.com/pages/s-params/eSB-1SP2T-A673_GRAPHPS.pdf</a>
Case style	<a href="https://www.minicircuits.com/case_style/WP3211.pdf">https://www.minicircuits.com/case_style/WP3211.pdf</a>
Software, user guide & programming manual	<a href="https://www.minicircuits.com/softwaredownload/solidstate.html">https://www.minicircuits.com/softwaredownload/solidstate.html</a>
Environmental rating	<a href="https://www.minicircuits.com/pcb/ENV55.pdf">https://www.minicircuits.com/pcb/ENV55.pdf</a>
Regulatory compliance	Refer to user guide for compliance information  <a href="https://www.minicircuits.com/app/AN49-012.pdf">https://www.minicircuits.com/app/AN49-012.pdf</a>
Support	<a href="mailto:testsolutions@minicircuits.com">testsolutions@minicircuits.com</a>

### INCLUDED ACCESSORIES

Photo	Part No.	Description
	USB-CBL-AC-3+	3.3 ft (1.0 m) USB cable: USB type A (Male) to USB type C (Male)

### OPTIONAL ACCESSORIES

Part No.	Description
USB-CBL-AC-3+ (spare)	3.3 ft (1.0 m) USB Cable: USB type A (Male) to USB type C (Male)
CBL-1.5FT-MMD+	1.5 ft (0.45 m) Cable assembly for serial control daisy chain with snap fit connectors
USB-AC/DC-5	AC/DC +5V power adaptor with USB connector <sup>9, 10</sup>

9. The power adaptor may be used to provide additional power via USB port when connecting several units in daisy chain control.

10. Includes power plugs for US, UK, EU, IL, AU & China. Plugs for other countries are also available. If you need a power cord for a country not listed please contact [testsolutions@minicircuits.com](mailto:testsolutions@minicircuits.com)

#### NOTES:

- A. Performance and quality attributes and conditions not expressly stated in this specification document are intended to be excluded and do not form a part of this specification document.
- B. Electrical specifications and performance data contained in this specification document are based on Mini-Circuit's applicable established test performance criteria and measurement instructions.
- C. The parts covered by this specification document are subject to Mini-Circuits standard limited warranty and terms and conditions (collectively, "Standard Terms"); Purchasers of this part are entitled to the rights and benefits contained therein. For a full statement of the Standard Terms and the exclusive rights and remedies thereunder, please visit Mini-Circuits' website at <https://www.minicircuits.com/terms/viewterm.html>

