

# Surface Mount Switch

50Ω SPDT, Absorptive DC<sup>4</sup> to 4.6 GHz

## KSWA-2-46+



CASE STYLE: XX112

### Maximum Ratings

Operating Temperature	-55°C to 100°C
Storage Temperature	-55°C to 150°C
Input Power	see Note 1
Control V	see Note 2

Permanent damage may occur if any of these limits are exceeded.

### Pin Connections

RF IN	2
RF OUT 1	5
RF OUT 2	8
CONTROL 1	3
CONTROL 2	1
GROUND	4,6,7

### Outline Drawing

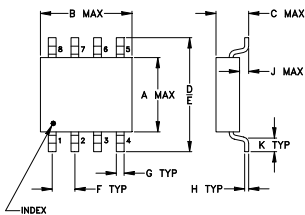

### PCB Land Pattern

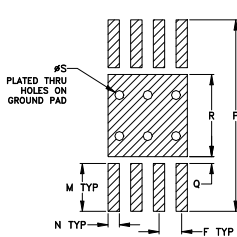

Suggested Layout, Tolerance to be within ±.002

### Outline Dimensions (inch/mm)

A	B	C	D	E	F	G	H	
.180	.180	.070	.400	.350	.050	.015	.005	
4.57	4.57	1.78	10.16	8.89	1.27	0.38	0.13	
J	K	M	N	P	Q	R	S	wt.
.005	.070	.105	.025	.420	.015	.180	.020	grams
0.13	1.78	2.67	0.64	10.67	0.38	4.57	0.51	0.15

### Demo Board MCL P/N: TB-204 Suggested PCB Layout (PL-217)

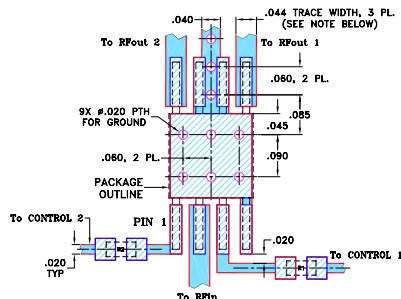

RESISTORS R1, R2: 100 Ohm, 0603 SIZE.  
 NOTE: 1. TRACE WIDTH IS SHOWN FOR ROGERS RO4350B WITH DIELECTRIC THICKNESS .020" ± .0015"; COPPER: 1/2 OZ. EACH SIDE. FOR OTHER MATERIALS TRACE WIDTH MAY NEED TO BE MODIFIED.  
 2. BOTTOM SIDE OF THE PCB IS CONTINUOUS GROUND PLANE.  
 DENOTES PCB COPPER LAYOUT WITH SMOBC (SOLDER MASK OVER BARE COPPER)  
 DENOTES COPPER LAND PATTERN FREE OF SOLDER MASK

### Notes

- Performance and quality attributes and conditions not expressly stated in this specification document are intended to be excluded and do not form a part of this specification document.
- Electrical specifications and performance data contained in this specification document are based on Mini-Circuit's applicable established test performance criteria and measurement instructions.
- The parts covered by this specification document are subject to Mini-Circuits standard limited warranty and terms and conditions (collectively, "Standard Terms"); Purchasers of this part are entitled to the rights and benefits contained therein. For a full statement of the Standard Terms and the exclusive rights and remedies thereunder, please visit Mini-Circuits' website at [www.minicircuits.com/MCLStore/terms.jsp](http://www.minicircuits.com/MCLStore/terms.jsp)

### Features

- wideband, DC to 4.6 GHz
- low insertion loss, 1.3 dB typ.
- hermetically sealed
- aqueous washable

### Applications

- PCN
- cellular
- 2-way radio
- receiver antenna switching

### Electrical Specifications

FREQ. <sup>4</sup> (GHz)	INSERTION LOSS (dB)				1dB COMPR. (dBm)			IN-OUT ISOLATION (dB)				
	DC-200 MHz	200-1000 MHz	1000-3000 MHz	3000-4600 MHz	DC-200 MHz	200-1000 MHz	1000-4600 MHz	DC-200 MHz	200-1000 MHz	1000-4600 MHz	Typ.	Min.
f <sub>L</sub>	0.8	0.9	1.5	1.5	10	17	27	60	45	50	40	30
f <sub>U</sub>	1.1	1.3	2.6	2.6								25
DC	4.6											

### Additional Specifications

Control Voltage, volts	
Low State	-0.2 to 0
High State (negative) for compression specs	-8
for other specs	-5 to -8
Control Current, mA	2.5 typ. at -8V
VSWR(:1)	1.3 typ.
Rise/Fall time (10%-90%), ns	2 typ.
Switching time, 50% of Control to 90% RF (Turn-on), ns	4 typ.
10% RF (Turn-off), ns	2.5 typ.
Video Leakage, mVp-p 0/-5V Control	30 typ.
MTBF, hrs @ 100°C case	11X10 <sup>6</sup>

### CONTROL LOGIC

Control Ports		RF outputs	
1	2	1	2
-V	0	On	Off
0	-V	Off	On

1. Max. Input RF power, +27 dBm except below 500 MHz +24 dBm
2. Control voltage (-10V) maximum.
3. Video leakage or break through is defined as leakage of switching signal to RF output ports.
4. All RF connections must be DC blocked or held at 0V DC.

### Electrical Schematic

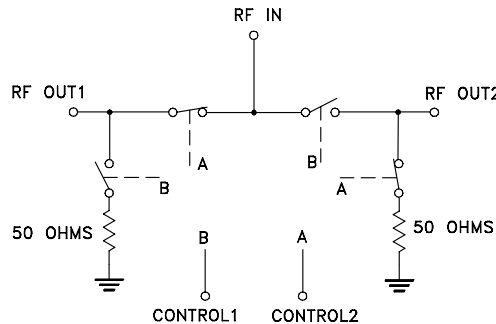

## Typical Performance Data

FREQ. (MHz)	ON INSERTION LOSS (dB) Control @ 0V/-5V IN-OUT		OFF ISOLATION (dB) Control @ 0V/-5V IN-OUT		IN	VSWR		
	—	σ	—	σ		ON	OUT	OFF
	x		x			x		x
3.00	0.55	0.01	82.53	2.67	1.12	1.12	1.02	
5.00	0.55	0.02	85.42	4.39	1.12	1.12	1.02	
10.00	0.55	0.02	84.71	7.84	1.13	1.13	1.02	
20.00	0.63	0.04	74.57	2.52	1.13	1.12	1.02	
50.00	0.62	0.02	64.87	0.76	1.12	1.12	1.02	
100.00	0.67	0.02	58.56	0.45	1.12	1.12	1.02	
200.00	0.72	0.02	54.29	0.36	1.12	1.11	1.02	
500.00	0.80	0.02	51.52	0.42	1.13	1.12	1.02	
911.55	0.90	0.02	48.87	1.18	1.16	1.11	1.04	
1000.00	0.90	0.03	48.56	1.23	1.17	1.10	1.05	
1581.00	1.01	0.04	44.26	1.63	1.20	1.04	1.11	
2107.00	1.10	0.03	39.70	1.28	1.30	1.09	1.14	
2370.00	1.15	0.05	37.89	1.12	1.31	1.11	1.15	
2489.55	1.26	0.06	37.25	0.97	1.32	1.14	1.17	
2752.55	1.32	0.07	35.59	0.62	1.41	1.22	1.23	
3278.55	1.26	0.04	31.74	1.06	1.44	1.35	1.29	
3804.55	1.63	0.09	28.75	0.72	1.39	1.41	1.38	
4330.55	1.52	0.06	25.75	0.41	1.49	1.78	1.65	
4474.00	1.47	0.09	25.51	0.36	1.57	1.94	1.73	
4600.00	1.98	0.06	25.42	0.32	1.55	1.87	1.67	

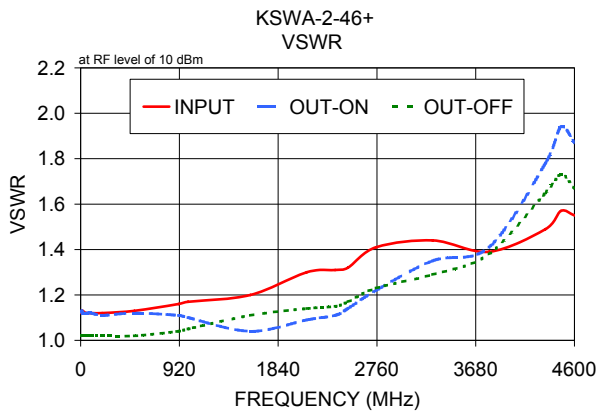
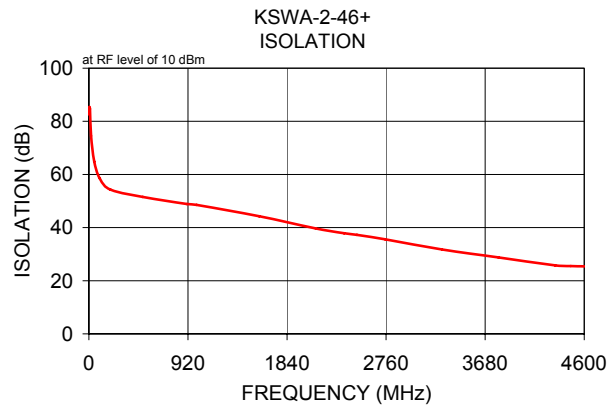
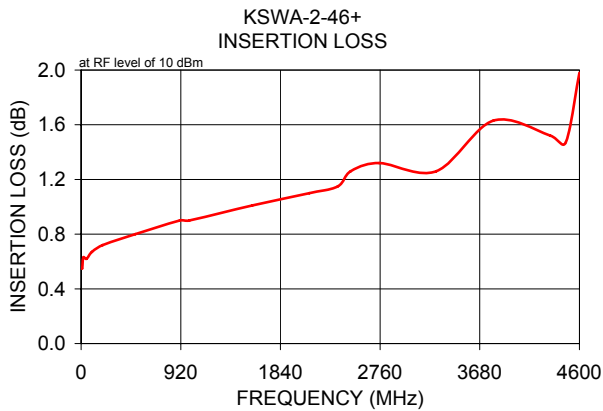

**Notes**

- A. Performance and quality attributes and conditions not expressly stated in this specification document are intended to be excluded and do not form a part of this specification document.
- B. Electrical specifications and performance data contained in this specification document are based on Mini-Circuit's applicable established test performance criteria and measurement instructions.
- C. The parts covered by this specification document are subject to Mini-Circuits standard limited warranty and terms and conditions (collectively, "Standard Terms"); Purchasers of this part are entitled to the rights and benefits contained therein. For a full statement of the Standard Terms and the exclusive rights and remedies thereunder, please visit Mini-Circuits' website at [www.minicircuits.com/MCLStore/terms.jsp](http://www.minicircuits.com/MCLStore/terms.jsp)

