

Ceramic Low Pass Filter

LFCN-2290-2+

50Ω DC to 2290 MHz

The Big Deal

- Rugged, ceramic construction
- Tiny size, 0.12 x 0.06 x 0.04"
- Excellent power handling, 10W

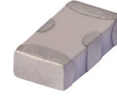

CASE STYLE: FV1206

Product Overview

Mini-Circuits' LFCN-2290-2+ is an LTCC low pass filter with a passband from DC to 2290 MHz, supporting a variety of applications. This model provides 0.9 dB passband insertion loss, 29 dB stopband rejection from 3110 to 3500 MHz, and 40 dB rejection from 3500 to 8000 MHz. It handles up to 10W RF input power and provides a wide operating temperature range from -55 to +100°C. Housed in a tiny 1206 ceramic form factor with wraparound terminations, the filter is ideal for dense PCB layouts and with minimal performance variation due to parasitics.

Key Features

Feature	Advantages
LTCC Construction	Provides repeatable performance in a rugged, ceramic package well suited for tough environments such as high humidity and temperature extremes.
Tiny size (0.12 x 0.06 x 0.04")	Saves space in dense circuit board layouts and minimizes the effects of parasitics.
High power handling, 10W	Supports a wide range of system power requirements.
Wrap-around terminations	Provides excellent solderability and easy visual inspection
Wide operating temperature range, -55 to +100°C	Enables reliable performance in extreme environments.



Ceramic

Low Pass Filter

50Ω

DC⁽¹⁾ to 2290 MHz

LFCN-2290-2+

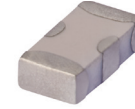

Generic photo used for illustration purposes only
CASE STYLE: FV1206

Features

- excellent power handling, 10W
- small size
- 7 sections
- temperature stable
- LTCC construction
- protected by U.S Patent 6,943,646

Applications

- harmonic rejection
- transmitters/receivers
- lab use

+RoHS Compliant
The +Suffix identifies RoHS Compliance. See our web site for RoHS Compliance methodologies and qualifications

Available Tape and Reel at no extra cost

Reel Size	Devices/Reel
7"	20, 50, 100, 200, 500, 1000, 3000

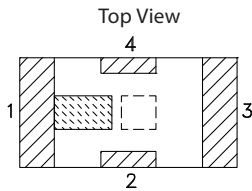
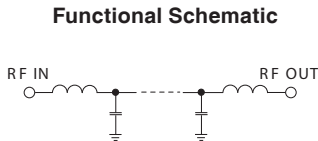
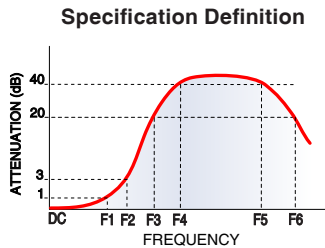

Pad Connections

Input	1
Output	3
Ground	2,4

Electrical Specifications^(1,2) at 25°C

Parameter	F#	Frequency (MHz)	Min.	Typ.	Max.	Unit	
Pass Band	Insertion Loss	DC-F1	DC-2290	—	0.9	1.5	dB
	Freq. Cut-Off	F2	2590	—	3.0	—	dB
	VSWR	DC-F1	DC-2290	—	1.3	—	:1
Stop Band	Rejection Loss	F3-F5	3110-8000	20	29	—	dB
		F4-F5	3500-8000	26	40	—	dB
	VSWR	F3-F5	3110-8000	—	25	—	:1

- (1) In Application where DC voltage is present at either input or output ports, coupling capacitors are required.
(2) Measured on Mini-Circuits Characterization Test Board TB-270.

Maximum Ratings

Operating Temperature	-55°C to +100°C
Storage Temperature	-55°C to +100°C
RF Power Input*	10W at 25°C

*Passband rating, derate linearly to 3.5W at 100°C ambient
Permanent damage may occur if any of these limits are exceeded.

Typical Performance Data at 25°C

Frequency (MHz)	Insertion Loss (dB)	VSWR (:1)
1	0.10	1.02
10	0.14	1.01
100	0.22	1.03
500	0.31	1.06
900	0.39	1.15
2000	0.82	1.37
2400	1.30	1.38
2600	3.56	2.74
3200	28.72	25.70
3600	55.21	27.88
4600	52.08	5.64
5000	49.40	30.52
6000	40.18	71.73
6600	36.50	45.00
7000	33.88	35.53
7600	33.99	23.55
8000	33.69	18.81

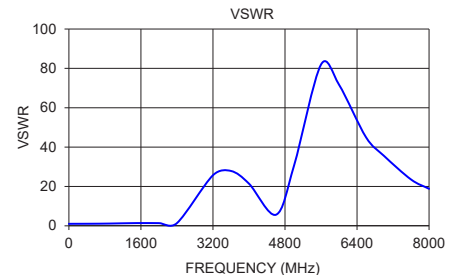
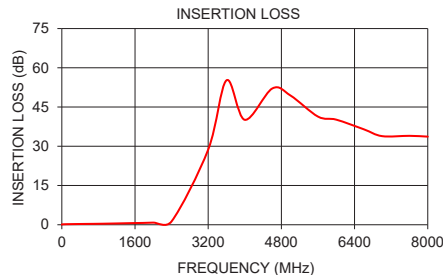

Low Pass Filter

LFCN-2290-2+

Outline Drawing

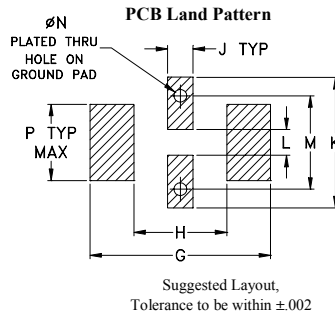
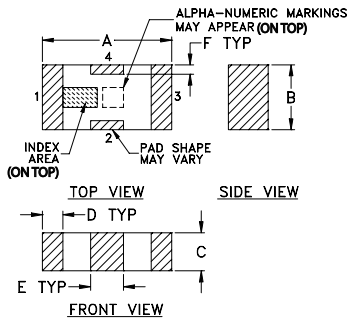

Demo Board MCL P/N: TB-270 Suggested PCB Layout (PL-137)

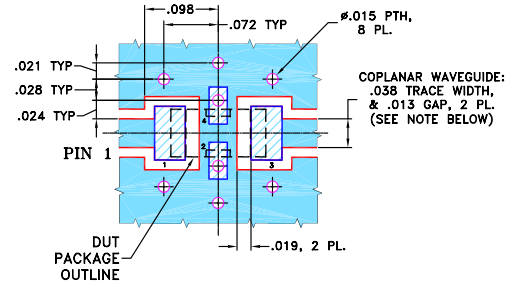

- NOTES:**
1. COPLANAR WAVEGUIDE PARAMETERS ARE SHOWN FOR ROGERS RO4350B WITH THICKNESS $.020" \pm .0015"$. COPPER: 1/2 OZ. EACH SIDE. FOR OTHER MATERIALS TRACE WIDTH & GAP MAY NEED TO BE MODIFIED.
 2. BOTTOM SIDE OF THE PCB IS CONTINUOUS GROUND PLANE.
- DENOTES PCB COPPER LAYOUT WITH SMOBC (SOLDER MASK OVER BARE COPPER)
 - DENOTES COPPER LAND PATTERN FREE OF SOLDER MASK

Pad Connections

Input	1
Output	3
Ground	2,4

Outline Dimensions (Inch/mm)

A	B	C	D	E	F	G	
.126	.063	.037	.020	.032	.009	.169	
3.20	1.60	0.94	0.51	0.81	0.23	4.29	
H	J	K	L	M	N	P	wt
.087	.024	.122	.024	.087	.012	.071	grams
2.21	0.61	3.10	0.61	2.21	0.30	1.80	.020

Additional Notes

- Performance and quality attributes and conditions not expressly stated in this specification document are intended to be excluded and do not form a part of this specification document.
- Electrical specifications and performance data contained in this specification document are based on Mini-Circuit's applicable established test performance criteria and measurement instructions.
- The parts covered by this specification document are subject to Mini-Circuits standard limited warranty and terms and conditions (collectively, "Standard Terms"); Purchasers of this part are entitled to the rights and benefits contained therein. For a full statement of the Standard Terms and the exclusive rights and remedies thereunder, please visit Mini-Circuits' website at www.minicircuits.com/MCLStore/terms.jsp

