

Surface Mount Power Splitter/Combiner

LRPQ-320J

2 Way-90° 50Ω 270 to 320 MHz

Maximum Ratings

Operating Temperature	-40°C to 85°C
Storage Temperature	-55°C to 100°C
Power Input (as a splitter)	1W max.

Permanent damage may occur if any of these limits are exceeded.

Pin Connections

SUM PORT	1
PORT 1 (0°)	3
PORT 2 (+90°)	6
GROUND	2,5
50 OHM TERM EXTERNAL	4

Outline Drawing

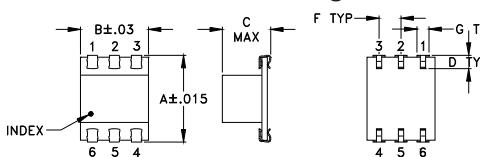

PCB Land Pattern

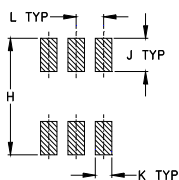

Suggested Layout,
Tolerance to be within ±.002

Outline Dimensions (inch/mm)

A	B	C	D	E	F	G		
.390	.31	.225	.060	--	.100	.045		
9.91	7.87	5.72	1.52	--	2.54	1.14		
H	J	K	L	M			wt	
.420	.120	.060	.100	--			grams	
10.67	3.05	1.52	2.54	--			0.50	

Demo Board MCL P/N: TB-226 Suggested PCB Layout (PL-140)

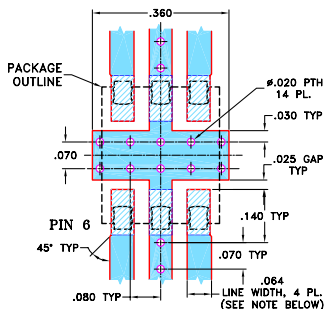

- NOTE:**
- TRACE WIDTH IS SHOWN FOR ROGERS RO4350B WITH DIELECTRIC THICKNESS .030" ± .002"; COPPER: 1/2 OZ. EACH SIDE. FOR OTHER MATERIALS TRACE WIDTH MAY NEED TO BE MODIFIED.
 - BOTTOM SIDE OF THE PCB IS CONTINUOUS GROUND PLANE.
- DENOTES PCB COPPER LAYOUT WITH SMOBC (SOLDER MASK OVER BARE COPPER)
 DENOTES COPPER LAND PATTERN FREE OF SOLDER MASK

Notes

- Performance and quality attributes and conditions not expressly stated in this specification document are intended to be excluded and do not form a part of this specification document.
- Electrical specifications and performance data contained in this specification document are based on Mini-Circuit's applicable established test performance criteria and measurement instructions.
- The parts covered by this specification document are subject to Mini-Circuits standard limited warranty and terms and conditions (collectively, "Standard Terms"); Purchasers of this part are entitled to the rights and benefits contained therein. For a full statement of the Standard Terms and the exclusive rights and remedies thereunder, please visit Mini-Circuits' website at www.minicircuits.com/MCLStore/terms.jsp

Features

- low insertion loss, 0.3 dB typ.
- good isolation, 21 dB typ.
- excellent phase unbalance 1 deg. typ.
- good return loss, VSWR 1.20:1 typ.
- aqueous washable

Applications

- UHF
- modulators
- balanced amplifiers
- image rejection mixers

Electrical Specifications

FREQ. RANGE (MHz)	ISOLATION (dB)	INSERTION LOSS (dB) Avg. of Coupled Outputs ABOVE 3 dB	PHASE UNBALANCE (Degrees)	AMPLITUDE UNBALANCE (dB)
f_L - f_U	Typ. Min.	Typ. Max.	Max.	Max.
270-320	21 18	0.3 0.6	3	1.2

LRPQ units have bottom barrier ground plane insulated with glass barrier.

Typical Performance Data

Frequency (MHz)	Total Loss ¹ (dB)		Amplitude Unbalance (dB)	Isolation (dB)	Phase Unbalance (deg.)	VSWR S	VSWR 1	VSWR 2
	S-1	S-2						
270.00	3.03	3.35	0.32	23.58	89.59	1.15	1.11	1.15
272.50	3.07	3.33	0.26	23.49	89.56	1.15	1.12	1.15
275.00	3.10	3.29	0.19	23.41	89.63	1.15	1.12	1.15
278.75	3.15	3.24	0.09	23.29	89.63	1.16	1.12	1.16
282.50	3.20	3.19	0.01	23.19	89.67	1.16	1.12	1.16
286.25	3.25	3.15	0.10	23.06	89.64	1.16	1.12	1.16
290.00	3.30	3.10	0.20	22.95	89.66	1.17	1.13	1.17
293.75	3.36	3.06	0.30	22.83	89.68	1.17	1.13	1.17
297.50	3.41	3.02	0.39	22.72	89.69	1.17	1.13	1.17
301.25	3.46	2.98	0.47	22.60	89.70	1.18	1.13	1.18
305.00	3.51	2.94	0.57	22.49	89.71	1.18	1.14	1.18
310.00	3.57	2.90	0.67	22.34	89.71	1.19	1.14	1.18
315.00	3.64	2.86	0.79	22.18	89.77	1.19	1.14	1.19
317.50	3.67	2.84	0.84	22.11	89.78	1.19	1.14	1.19
320.00	3.71	2.82	0.89	22.03	89.77	1.20	1.15	1.19

1. Total Loss = Insertion Loss + 3dB splitter loss.

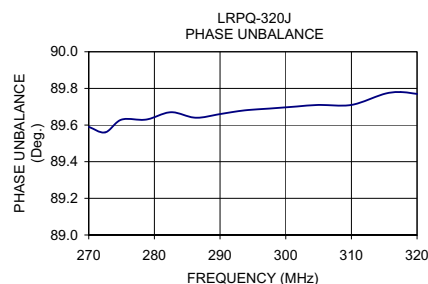
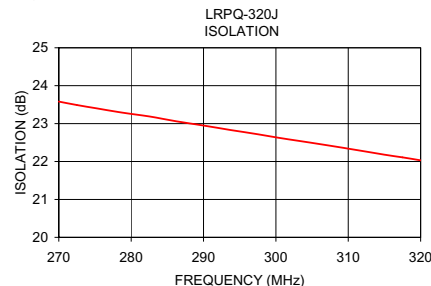
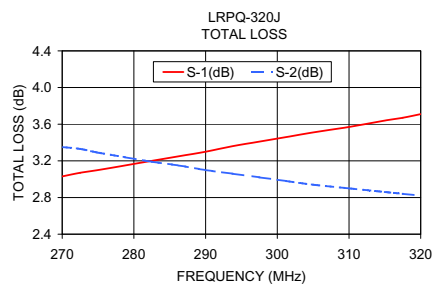

electrical schematic

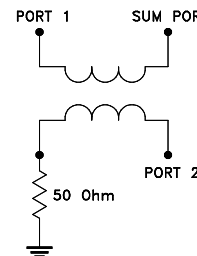

Mini-Circuits®

www.minicircuits.com P.O. Box 350166, Brooklyn, NY 11235-0003 (718) 934-4500 sales@minicircuits.com

REV. B
M151107
LRPQ-320J
HY/TD/CP
200818



Generic photo used for illustration purposes only

CASE STYLE: QQQ569