

High IP3

Frequency Mixer

Level 17 (LO Power+17 dBm) 3500 to 3600 MHz

Maximum Ratings

Operating Temperature	-55°C to 100°C
Storage Temperature	-55°C to 100°C
LO & RF Power	20 dBm
Permanent damage may occur if any of these limits are exceeded.	

Pin Connections

LO	10
RF	5
IF	3
GROUND	1,2,4,6,7,8,9

Outline Drawing

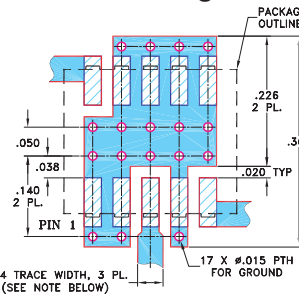

NOTES: 1. TRACE WIDTH IS SHOWN FOR ROGERS RO435 THICKNESS .020" ± .0015"; COPPER: 1/2 OZ FOR OTHER MATERIALS TRACE WIDTH MAY NEED TO BE MODIFIED.
 2. BOTTOM SIDE OF THE PCB IS CONTINUOUS GR
 DENOTES PCB COPPER LAYOUT WITH SM (SOLDER MASK OVER BARE COPPER)
 DENOTES COPPER LAND PATTERN FREE

Outline Dimensions (inch/mm)

A	B	C	D	E	F	G
.30	.250	.190	.266	.050	.050	.012
7.62	6.35	4.83	6.76	1.27	1.27	0.30
H	J	K	L	M	wt	
.029	.004	.085	.296	.030	grams	
0.74	0.10	2.16	7.52	0.76	0.5	

Demo Board MCL P/N: TB-144 Suggested PCB Layout (PL-045)

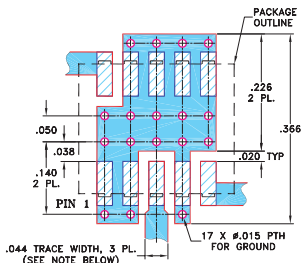

NOTES: 1. TRACE WIDTH IS SHOWN FOR ROGERS RO4350B WITH DIELECTRIC THICKNESS .020" ± .0015"; COPPER: 1/2 OZ. EACH SIDE. FOR OTHER MATERIALS TRACE WIDTH MAY NEED TO BE MODIFIED.
 2. BOTTOM SIDE OF THE PCB IS CONTINUOUS GROUND PLANE.
 DENOTES PCB COPPER LAYOUT WITH SMOBC (SOLDER MASK OVER BARE COPPER)
 DENOTES COPPER LAND PATTERN FREE OF SOLDER MASK

Notes

- A. Performance and quality attributes and conditions not expressly stated in this specification document are intended to be excluded and do not form a part of this specification document.
- B. Electrical specifications and performance data contained in this specification document are based on Mini-Circuit's applicable established test performance criteria and measurement instructions.
- C. The parts covered by this specification document are subject to Mini-Circuit's standard limited warranty and terms and conditions (collectively, "Standard Terms"); Purchasers of this part are entitled to the rights and benefits contained therein. For a full statement of the Standard Terms and the exclusive rights and remedies thereunder, please visit Mini-Circuit's website at www.minicircuits.com/MCLStore/terms.jsp

Features

- excellent IP3, 33 dBm typ.
- excellent L-R isolation, 44 dB typ.
- excellent 1dB compression, RF>LO power
- industry standard foot print
- LTCC design for excellent temperature stability, performance repeatability and small size
- aqueous washable
- double balanced mixer
- low price
- protected by US Patent 6,959,180

Applications

- line of sight links
- satellite communications
- WiMAX

Electrical Specifications (T_{AMB} = -55°C to 100°C)

FREQUENCY (MHz)			IP3 (dBm)	RF in at 1 dB compr. (dBm)	CONVERSION LOSS (dB)		LO-RF ISOLATION (dB)		LO-IF ISOLATION (dB)	
RF	LO	IF			Typ.	Max.	Typ.	Min.	Typ.	Min.
3500-3600	3070-3170	380-480	33	17	8.3	9.2	44	20	29	15

Typical Performance Data

Frequency (MHz)		Conversion Loss (dB)	Isolation L-R (dB)	Isolation L-I (dB)	VSWR RF Port (:1)	VSWR LO Port (:1)	IP3 (dBm)
RF	LO	LO +17dBm	LO +17dBm	LO +17dBm	LO +17dBm	LO +17dBm	LO +17dBm
3500.00	3070.00	7.59	45.92	24.67	2.28	3.64	32.03
3510.00	3080.00	7.73	44.66	25.03	2.46	3.78	32.45
3520.00	3090.00	8.10	44.30	25.49	2.65	3.82	34.10
3530.00	3100.00	8.11	45.26	26.04	2.84	3.70	32.67
3540.00	3110.00	8.00	46.98	26.41	3.00	3.62	32.06
3550.00	3120.00	8.07	47.77	26.73	3.14	3.57	33.59
3560.00	3130.00	7.93	49.60	26.97	3.30	3.54	33.95
3570.00	3140.00	7.42	54.93	27.26	3.49	3.60	32.32
3580.00	3150.00	7.14	55.81	27.70	3.75	3.71	32.46
3590.00	3160.00	7.37	52.08	28.30	4.02	3.74	32.93
3600.00	3170.00	7.62	50.58	28.99	4.37	3.75	32.34

Electrical Schematic

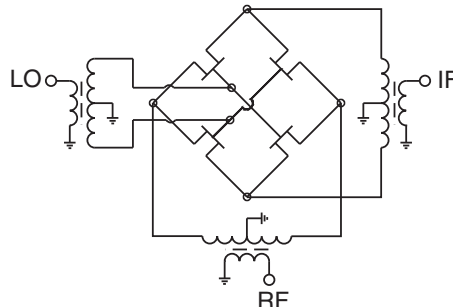

CASE STYLE: DZ883

+RoHS Compliant

The +Suffix identifies RoHS Compliance. See our web site for RoHS Compliance methodologies and qualifications

Available Tape and Reel at no extra cost

Reel Size	Devices/Reel
7"	10, 20, 50, 100, 200
13"	500, 1000



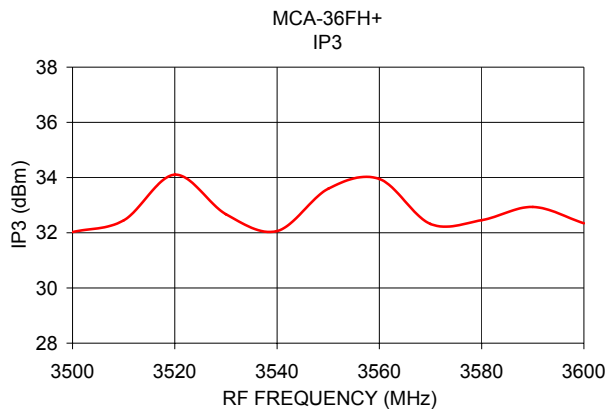
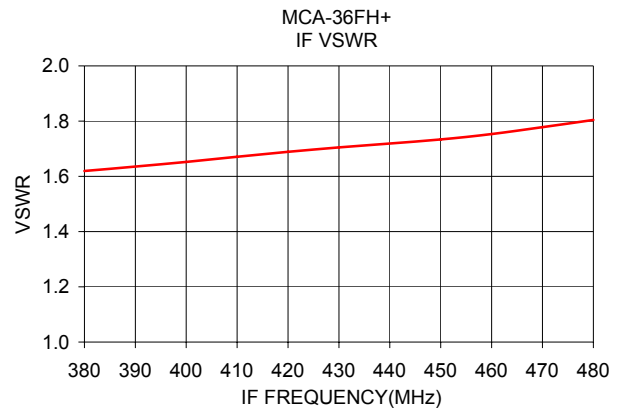
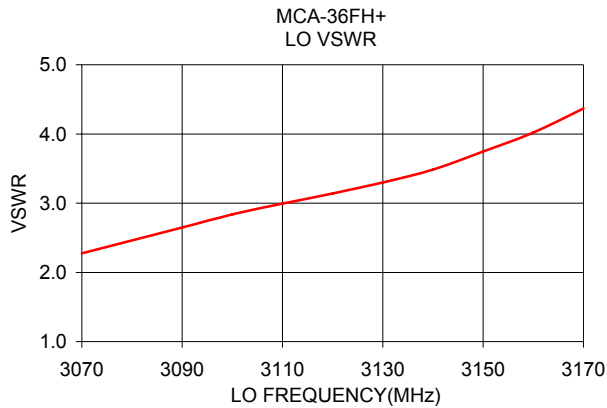
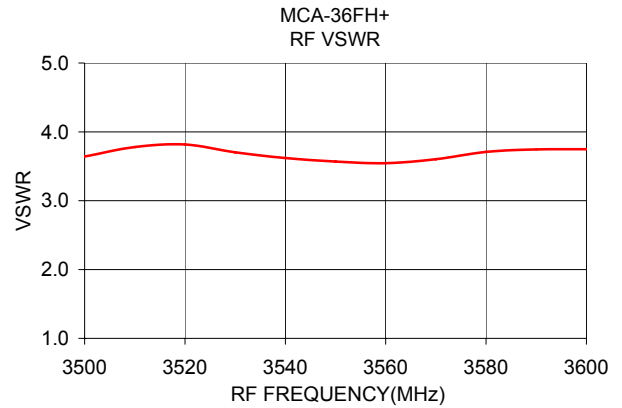
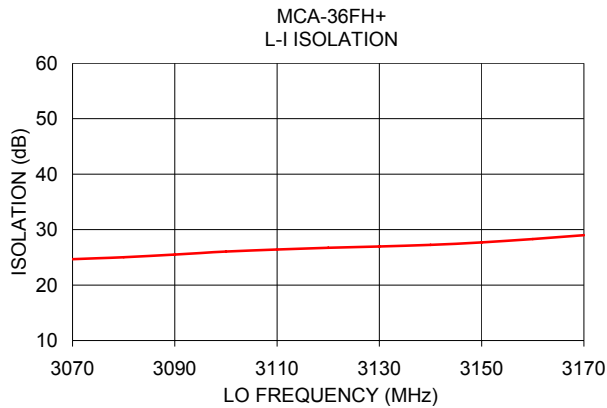
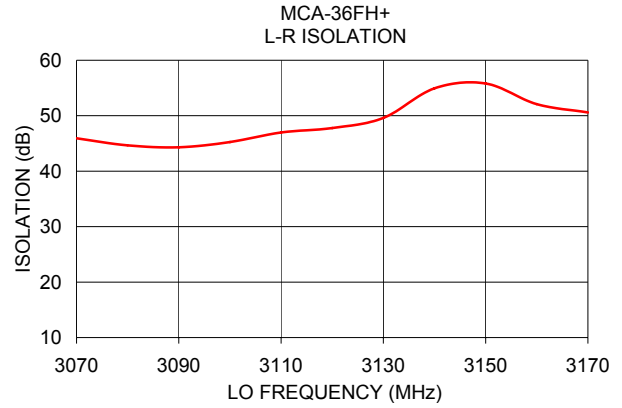
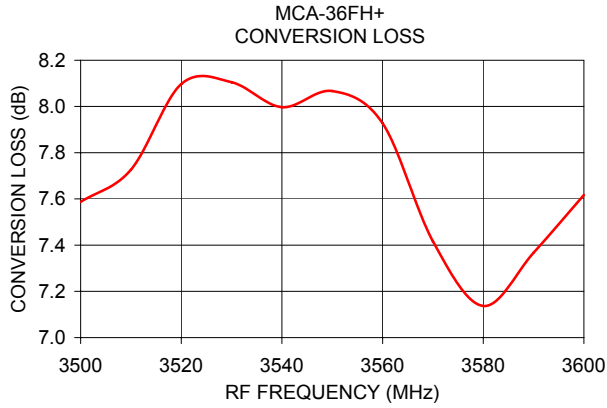

Notes

- A. Performance and quality attributes and conditions not expressly stated in this specification document are intended to be excluded and do not form a part of this specification document.
- B. Electrical specifications and performance data contained in this specification document are based on Mini-Circuit's applicable established test performance criteria and measurement instructions.
- C. The parts covered by this specification document are subject to Mini-Circuits standard limited warranty and terms and conditions (collectively, "Standard Terms"); Purchasers of this part are entitled to the rights and benefits contained therein. For a full statement of the Standard Terms and the exclusive rights and remedies thereunder, please visit Mini-Circuits' website at www.minicircuits.com/MCLStore/terms.jsp