



ULTRA-SMALL CERAMIC

Power Splitter/Combiner

QCN-45D+

Mini-Circuits

2 Way-90° 50Ω 2500 to 4500 MHz

FEATURES

- Low insertion loss, 0.4 dB typ.
- Wide band, 2500-4500 MHz
- Wrap-around terminal for excellent solderability
- Ultra small, 0.12"X0.06"X0.035"
- Patent pending

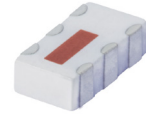

Generic photo used for illustration purposes only

CASE STYLE: FV1206-1

+RoHS Compliant

The +Suffix identifies RoHS Compliance. See our web site for RoHS Compliance methodologies and qualifications

APPLICATIONS

- Balanced amplifiers
- Modulators
- MMDS
- Defense communications

ELECTRICAL SPECIFICATIONS AT 25°C

Parameter	Frequency (MHz)	Min.	Typ.	Max.	Unit
Frequency Range		2500		4500	MHz
Insertion Loss, above 3.0 dB	2500-3500		0.4	0.7	dB
	3500-4500		0.5	0.8	
Isolation	2500-3500	16	22		dB
	3500-4500	15	19		
Phase Unbalance	2500-3500		1	4	Degree
	3500-4500		3	6	
Amplitude Unbalance	2500-3500		0.5	1.7	dB
	3500-4500		1.0	2.1	
VSWR	2500-3500		1.2		(:1)
	3500-4500		1.2		

1. For applications requiring DC voltage to be applied to the RF ports. DC resistance to ground is 100 Mohms min.

MAXIMUM RATINGS

Parameter	Ratings
Operating Temperature	-55°C to 100°C
Storage Temperature	-55°C to 100°C
Power Input (as a splitter)	15W* max.

* Derate linearly to 7W at 100°C ambient. Permanent damage may occur if any of these limits are exceeded.

ELECTRICAL SCHEMATIC (NOTE 1)

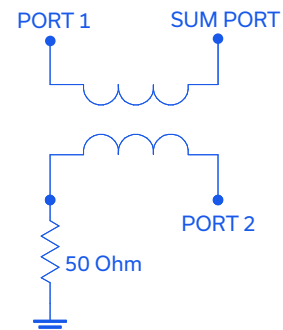

www.minicircuits.com P.O. Box 350166, Brooklyn, NY 11235-0003 (718) 934-4500 sales@minicircuits.com

REV. F
ECO-010311
QCN-45D+
ED-12169
AD/TD/CP/AM
211026
PAGE 1 OF 3



PIN CONNECTIONS

SUM PORT	1
PORT 1 (0°)	4
PORT 2 (+90°)	6
GROUND	2,5
50 OHM TERM EXTERNAL	3

PRODUCT MARKING: SA

DEMO BOARD MCL P/N: TB-405
SUGGESTED PCB LAYOUT (PL-250)

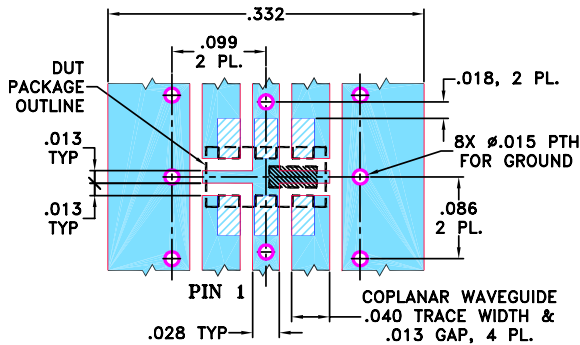

NOTES: 1. TRACE WIDTH IS SHOWN FOR ROGERS RO4350B WITH DIELECTRIC THICKNESS $0.020" \pm 0.0015"$; COPPER: 1/2 OZ. EACH SIDE. FOR OTHER MATERIALS TRACE WIDTH MAY NEED TO BE MODIFIED.
2. BOTTOM SIDE OF THE PCB IS CONTINUOUS GROUND PLANE.

- DENOTES PCB COPPER LAYOUT WITH SMOBC (SOLDER MASK OVER BARE COPPER)
- DENOTES COPPER LAND PATTERN FREE OF SOLDER MASK

OUTLINE DRAWING

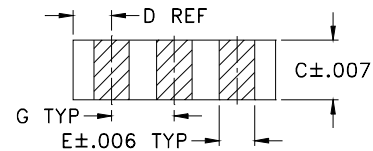
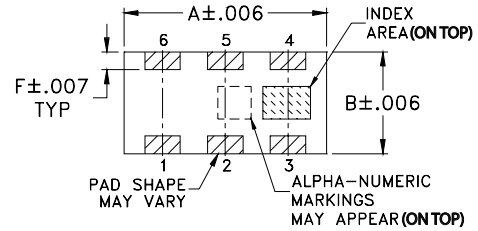

PCB Land Pattern

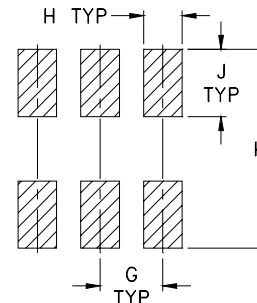

Suggested Layout,
Tolerance to be within ± 0.02

OUTLINE DIMENSIONS (Inches/mm)

A	B	C	D	E	F	
.126	.063	.035	.024	.022	.011	
3.20	1.60	0.89	0.61	0.56	0.28	
G	H	J	K			wt
.039	.024	.042	.123			grams
0.99	0.61	1.07	3.12			.020

TAPE & REEL INFORMATION: F75



TYPICAL PERFORMANCE DATA

Frequency (MHz)	Total Loss ¹ (dB)		Amplitude Unbalance (dB)	Isolation (dB)	Phase Unbalance (deg.)	VSWR (:1)		
	S-1	S-2				S	1	2
2500.00	3.04	3.82	0.78	18.35	88.41	1.20	1.21	1.26
2600.00	3.14	3.68	0.54	18.66	88.69	1.19	1.18	1.24
2800.00	3.36	3.44	0.09	19.11	89.21	1.18	1.13	1.20
2900.00	3.46	3.35	0.11	19.15	89.40	1.19	1.11	1.18
3100.00	3.64	3.20	0.44	19.20	89.79	1.22	1.08	1.17
3200.00	3.72	3.14	0.57	19.10	89.97	1.22	1.08	1.16
3400.00	3.86	3.06	0.80	18.69	90.28	1.25	1.08	1.12
3500.00	3.93	3.03	0.90	18.48	90.38	1.27	1.09	1.11
3600.00	3.99	3.02	0.97	18.13	90.47	1.29	1.10	1.12
3800.00	4.09	3.00	1.09	17.47	90.65	1.32	1.11	1.12
4000.00	4.15	3.00	1.15	16.86	90.87	1.33	1.12	1.12
4100.00	4.16	3.00	1.16	16.63	90.98	1.34	1.12	1.13
4200.00	4.17	3.02	1.15	16.38	91.08	1.35	1.12	1.13
4300.00	4.17	3.05	1.13	16.23	91.21	1.35	1.13	1.14
4500.00	4.13	3.12	1.01	16.03	91.48	1.36	1.13	1.13

1. Total Loss = Insertion Loss + 3 dB splitter loss.

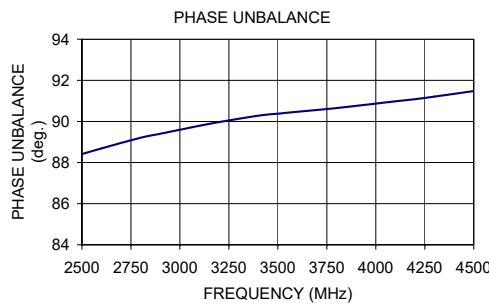
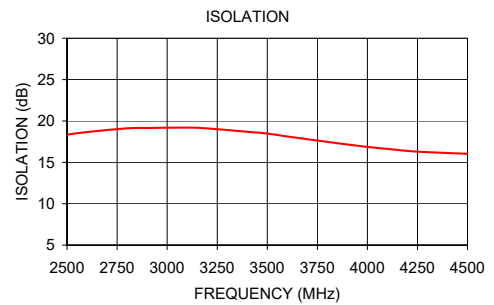
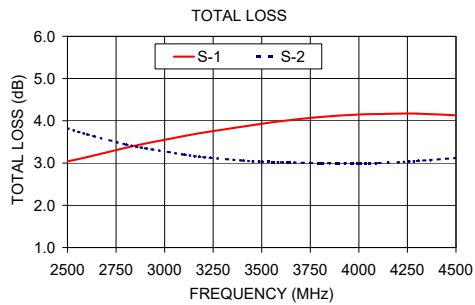

- NOTES**
- A. Performance and quality attributes and conditions not expressly stated in this specification document are intended to be excluded and do not form a part of this specification document.
 - B. Electrical specifications and performance data contained in this specification document are based on Mini-Circuit's applicable established test performance criteria and measurement instructions.
 - C. The parts covered by this specification document are subject to Mini-Circuits standard limited warranty and terms and conditions (collectively, "Standard Terms"); Purchasers of this part are entitled to the rights and benefits contained therein. For a full statement of the standard. Terms and the exclusive rights and remedies thereunder, please visit Mini-Circuits' website at www.minicircuits.com/MCLStore/terms.jsp

