

50Ω 0.1 to 40 GHz

## The Big Deal

- Precision attenuation up to 40 GHz
- Fine resolution, 0.5 dB
- Fast transitions, 100 ns
- **USB and Ethernet** control
- Control up to 25 attenuators via a single interface via 'Daisy Chain' connection



Software Package

Case Style: MS2523

## Applications

- Transmission loss simulation
- 5G network infrastructure
- Microwave point to point links
- VHF / UHF / L / S / C / X / Ku / K band testing

### Included Accessories

Model No.	Description	Qty.
MUSB-CBL-3+	2.6 ft. USB cable	1

## Product Overview

Mini-Circuits' RCDAT-40G-30 is a precision programmable attenuator covering an extremely wide bandwidth, from 0.1 to 40 GHz. Its unique design allows attenuation settings to be programmed from 0 to 30 dB, in 1.0 dB steps (Mode 1) and 0 to 29 dB in 0.5 dB steps (Mode 2) with monotonic attenuation change per dB, even at the highest frequencies and attenuation settings.

The attenuator can be controlled via USB or Ethernet, allowing control directly from a PC, or remotely over a network. Full software support is provided, including our user-friendly GUI application for Windows and a full API with programming instructions for Windows and Linux environments (both 32-bit and 64-bit systems).

This model also includes Mini-Circuits' novel dynamic addressing daisy-chaining interface which allows multiple RCDAT-40G-30 attenuators to be connected together into a Master / Slave chain, with independent control of each attenuator channel through the single USB or Ethernet connection of the master unit.

## Key Features

Feature	Advantages
Extremely wide bandwidth	A single attenuator covers a diverse range of RF and microwave applications from 0.1 to 40 GHz
Daisy chain control (dynamic addressing)	Simplify control software and interconnections by cascading up to twenty five modules
USB & Ethernet control	USB HID and Ethernet (HTTP / Telnet) interfaces provide easy compatibility with a wide range of software setups and programming environments
Programmable attenuation sweep and Hop sequences	The RCDAT-40G-30 can be programmed with a timed sequence of attenuation settings, to run without any additional external control.
Full software support	User friendly Windows GUI (graphical user interface) allows manual control straight out of the box, while the comprehensive API (application programming interface) with examples and instructions allows easy automation in most programming environments. For details and download link see <a href="https://www.minicircuits.com/softwaredownload/patt.html">https://www.minicircuits.com/softwaredownload/patt.html</a>

**Trademarks:** Windows is a registered trademark of Microsoft Corporation in the United States and other countries. Linux is a registered trademark of Linus Torvalds. Mac is a registered trademark of Apple Corporation. Pentium is a registered trademark of Intel Corporation. Neither Mini-Circuits nor the Mini-Circuits RCDAT-series attenuators are affiliated with or endorsed by the owners of the above referenced trademarks.

Mini-Circuits and the Mini-Circuits logo are registered trademarks of Scientific Components Corporation.



## Electrical Specifications<sup>1</sup> at +25°C

Parameter	Frequency range	Conditions	Min.	Typ.	Max.	Units
Frequency range	–	–	0.1	–	40	GHz
Attenuation range	Mode 1 <sup>8</sup>	1 dB step	0	–	30	dB
	Mode 2 <sup>9</sup>	0.5 dB step				
Attenuation accuracy	0.1 - 8 GHz	@ 0.5 - 8 dB @ 8.5 - 30 dB	– –	±0.5 ±1.0	– –	dB
	8 - 16 GHz	@ 0.5 - 8 dB @ 8.5 - 30 dB	– –	±0.5 ±1.0	– –	
	16 - 24 GHz	@ 0.5 - 8 dB @ 8.5 - 30 dB	– –	±1.0 ±1.5	– –	
	24 - 32 GHz	@ 0.5 - 8 dB @ 8.5 - 30 dB	– –	±1.0 ±2.0	– –	
	32 - 40 GHz	@ 0.5 - 8 dB @ 8.5 - 30 dB	– –	±1.0 ±1.5	– –	
Insertion Loss	0.1 - 8 GHz	@ 0 dB	–	6.0	8.0	dB
	8 - 16 GHz		–	9.0	11.0	
	16 - 24 GHz		–	12.0	15.0	
	24 - 32 GHz		–	14.0	16.0	
	32 - 40 GHz		–	14.0	16.0	
Isolation In-Out	0.1 - 40 GHz	Note 2	–	40	–	dB
Input operating power <sup>3</sup> (RF In or RF Out ports)	0.1 - 40 GHz	@ 0 - 30 dB	–	–	24	dBm
IP3 Input <sup>4</sup>	0.1 - 40 GHz	@ 0 dB setting (P <sub>IN</sub> =+5 dBm)	–	+38	–	dBm
VSWR	0.1 - 40 GHz	@ 0 - 30 dB	–	1.50	–	:1
Min Dwell Time <sup>5</sup>	0.1 - 40 GHz	High speed mode	–	600	–	µs
Attenuation Transition Time <sup>6</sup>	0.1 - 40 GHz	–	–	100	–	ns
Supply Voltage	–	via USB or serial control	4.75	5	5.25	V
DC current draw <sup>7</sup>	–	Ethernet Enabled	–	400	450	mA
	–	Ethernet Disabled	–	250	300	

<sup>1</sup> Attenuator RF ports are interchangeable, and support simultaneous, bidirectional signal transmission, however the specifications are guaranteed for the RF In and RF Out as noted on the label. There may be minor changes in performance when injecting signals to the RF Out port.

<sup>2</sup> Isolation is defined as max attenuation plus insertion loss; this is the path loss through the attenuator when initially powered up. After a brief delay (~0.5 sec typically) the attenuator will revert to a user defined "power-up" state (either max attenuation or a pre-set value).

<sup>3</sup> Total operating input power on RF In or RF Out ports to bring the attenuator to about 0.1dB compression.

<sup>4</sup> Tested with 1 MHz offset between signals.

<sup>5</sup> Minimum Dwell Time is the time the RCDAT will take to respond to a command to change attenuation states without communication delays. In PC control mode add communication delays (on the order of ms for USB) to get actual response time.

<sup>6</sup> Attenuation Transition Time is specified as the time between starting to change the attenuation state and settling on the requested attenuation state.

<sup>7</sup> DC current consumption shown for a single attenuator, without any slaves connected in series.

<sup>8</sup> Attenuation range in Mode 1 operation is 30 dB with 1 dB step.

<sup>9</sup> Attenuation range in Mode 2 operation is 29 dB with 0.5 dB step.

## Absolute Maximum Ratings

Operating Temperature	0°C to 50°C
Storage Temperature	-20°C to 85°C
V <sub>USB</sub> Max.	6V
Total RF power for RF In & RF Out	+35 dBm
DC voltage at RF port	+25V

Permanent damage may occur if any of these limits are exceeded. Operating in the range between operating power limits and absolute maximum ratings for extended periods of time may result in reduced life and reliability.

## Connections

RF In	(2.92mm female)
RF Out	(2.92mm female)
USB	(USB type Mini-B female)
Network (Ethernet/LAN)	(RJ45 socket)
Serial Control Out	(10 Pin Digital Snap Fit female) <sup>8</sup>
Serial Control In	(10 Pin Digital Snap Fit female) <sup>8</sup>

<sup>8</sup> Mating connector is Hirose ST40X-10S-CV(30)

## RCDAT response to communication interrupt

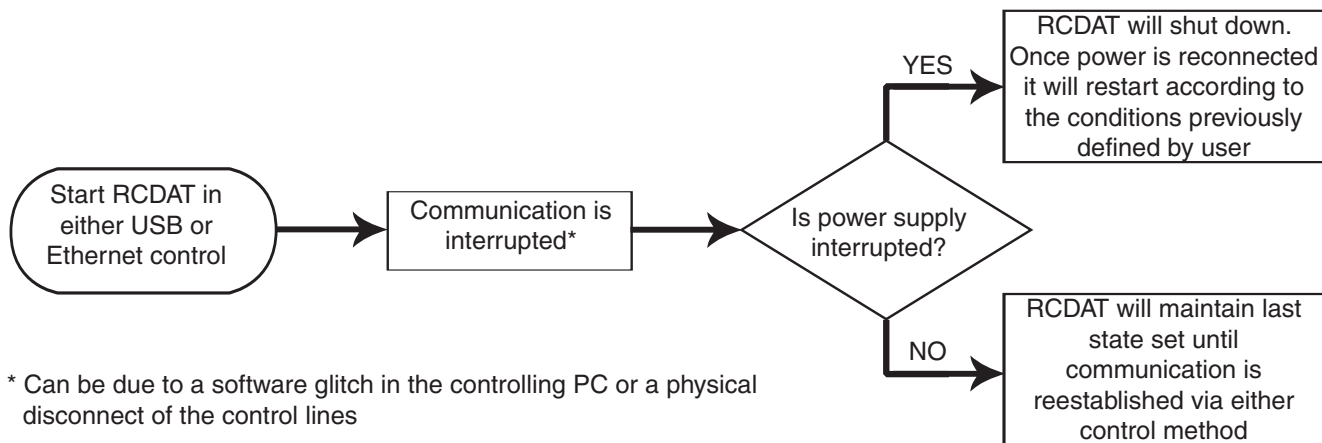

## Block Diagram

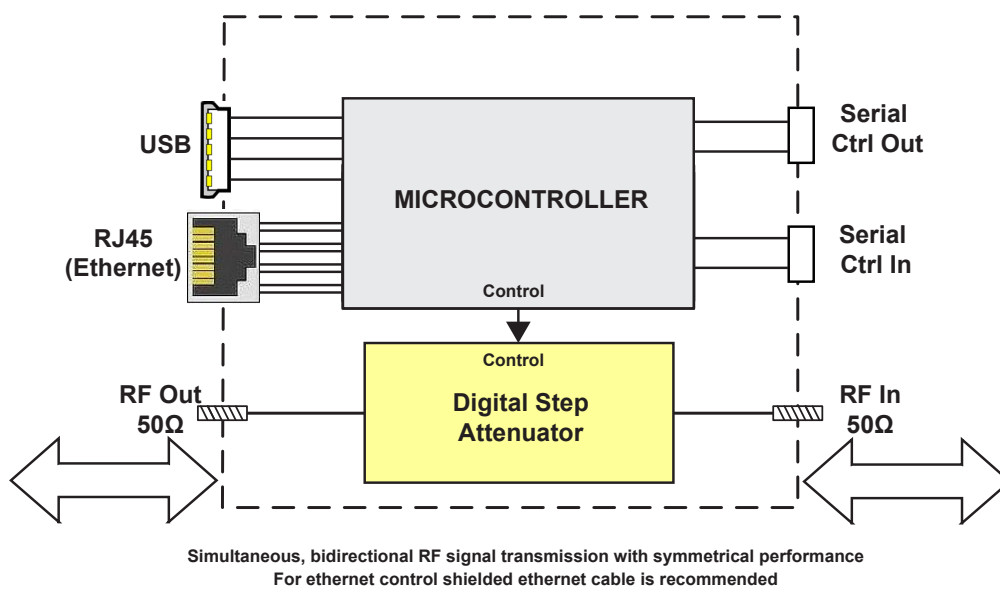

## Connecting multiple modules (Daisy Chain)

The RCDAT-40G-30 is designed to connect up to 25 modules in series (Daisy chain) using dynamic addressing, meaning there is no need to specifically set the address of the modules, the addresses will be set automatically as part of establishing the communications with the PC. The module connected to the PC USB port or LAN connection will be assigned address 0 (Master), the first module connected to it will get address 1 (slave) and subsequent modules incrementing up to address 24 (slave).

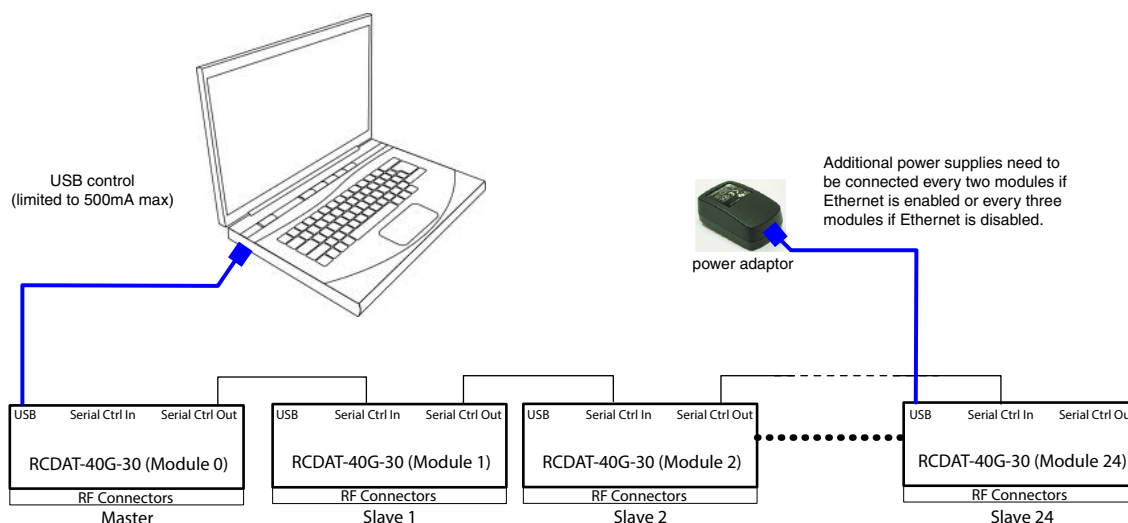

Connections between modules will be made using the serial in/out ports with the module connected to the PC as a master and all other as slave modules. All control will be through the master module (address zero) which is the only one communicating with the PC (via USB or Ethernet). Serial control out port of each module should be connected to the serial control in port of the next module. Power can be supplied from the PC via the master module or from additional power supplies connected to the USB ports of slave units.

Note that with Ethernet enabled each unit will draw up to 450 mA so to connect three units in series you will need to supply 1350mA, thus it is recommended to turn off the Ethernet circuitry in the slave units to reduce the power requirements. Connecting an additional power supply will automatically cut off power draw from the serial control in port for the module connected.

The Serial master/slave bus allows connecting modules of different types to the same daisy chain as long as all support Mini-Circuits dynamic addressing setup. To add a new module to the set up simply connect the module to the setup and refresh the address listing, no need to reset any of the existing modules or assign addresses manually.

Note: Different module types may have different current consumption which will change the number of units which can be connected before additional power supply is needed.

## Controlling multiple modules in GUI program

Connect the attenuator you wish to use as master to either USB or LAN and connect additional units to the master using the serial control in/out ports and CBL-1.5FT-MMD+ or equivalent control cables, then start the GUI and select the control method you wish to use (USB, HTTP or Telnet, RS232 is not available in this model)

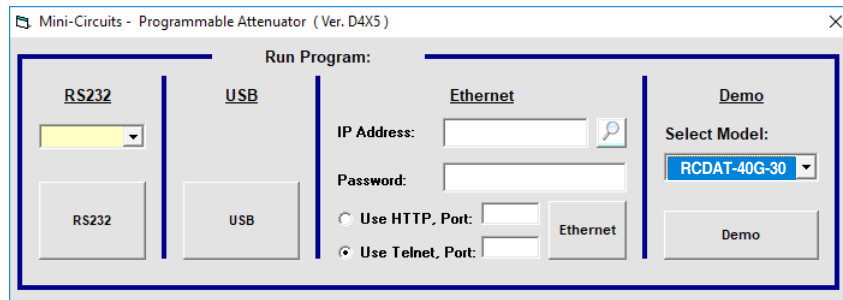

RCDAT GUI initial (control selection) screen

Once you've selected the control method the main attenuation control screen will appear, allowing you to set a fixed attenuation, an arbitrary sequence of attenuation steps, or a sweep(ramp) of attenuation for each attenuator, or for a number of attenuators at once.

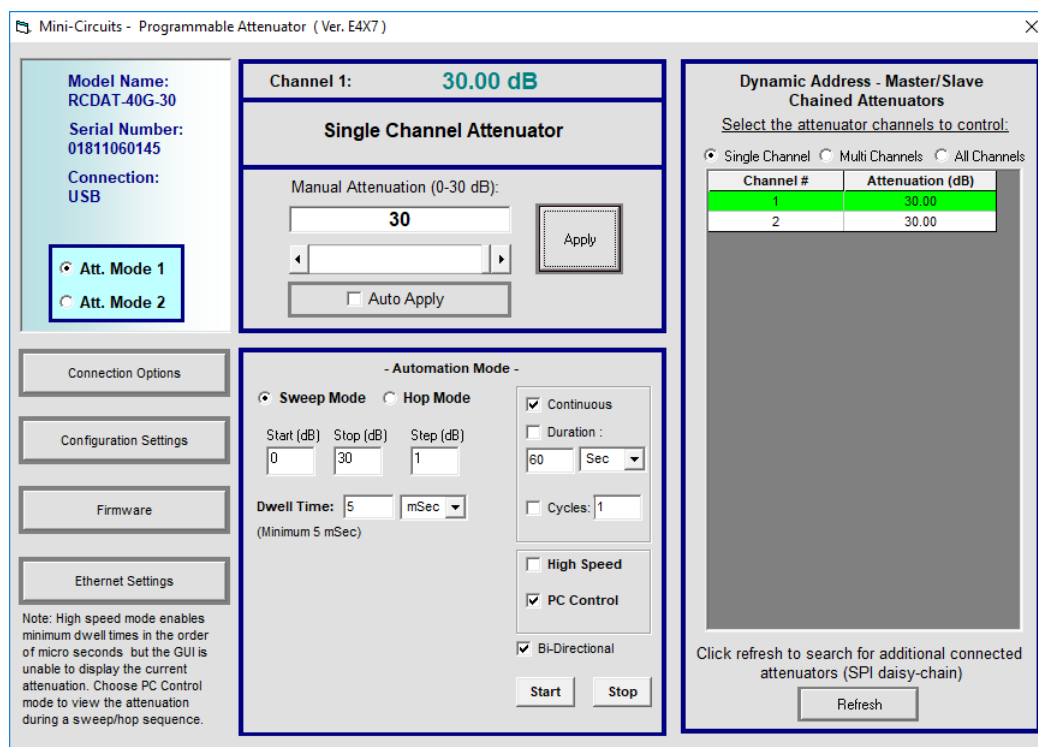

RCDAT GUI main screen (USB control) with 2 units connected in series

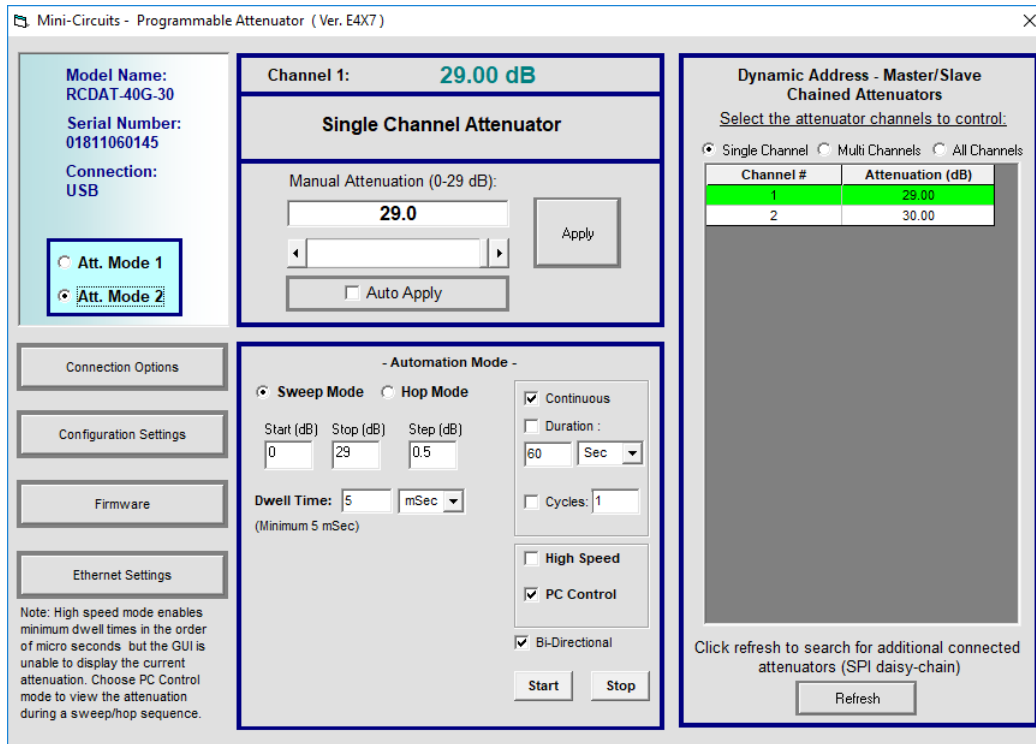

RCDAT GUI main screen (USB control) with 2 units connected in series

## Outline Drawing (MS2523)

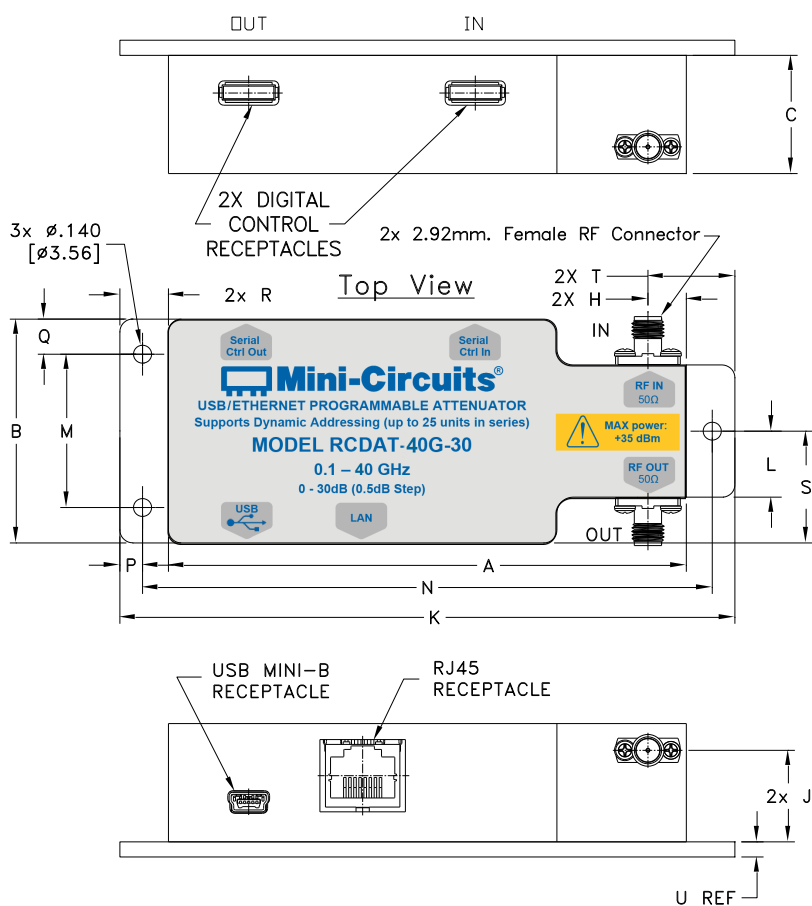

## Connections

RF In	(2.92mm female)
RF Out	(2.92mm female)
USB	(USB type Mini-B female)
Network (Ethernet/LAN)	(RJ45 socket)
Serial Control Out	(10 Pin Digital Snap Fit female) <sup>8</sup>

<sup>8</sup> Mating connector is Hirose ST40X-10S-CV(30)

inch  
mm

A	B	C	D	E	F	G	H	J	K	L	M	N	P	Q	R	S	T	U	wt
4.00	1.75	0.92	--	--	--	--	0.30	0.72	4.75	0.52	1.20	4.40	0.18	0.28	0.38	0.87	0.67	0.12	grams
101.60	44.45	23.49	--	--	--	--	7.54	18.19	120.65	13.11	30.45	111.76	4.45	6.99	9.53	22.20	17.06	3.00	520.0

## Typical Performance Curves @+25°C (Mode 1)

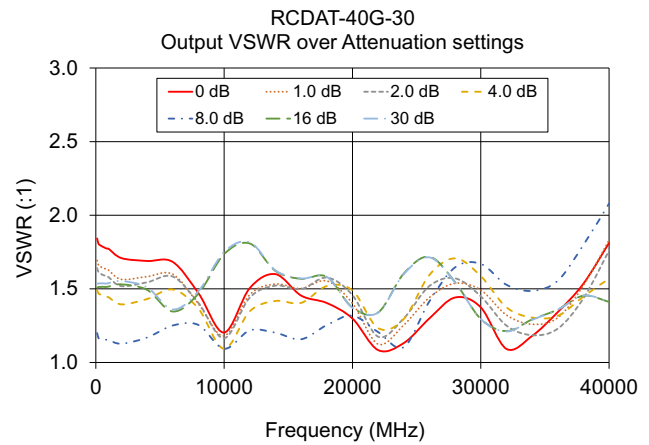
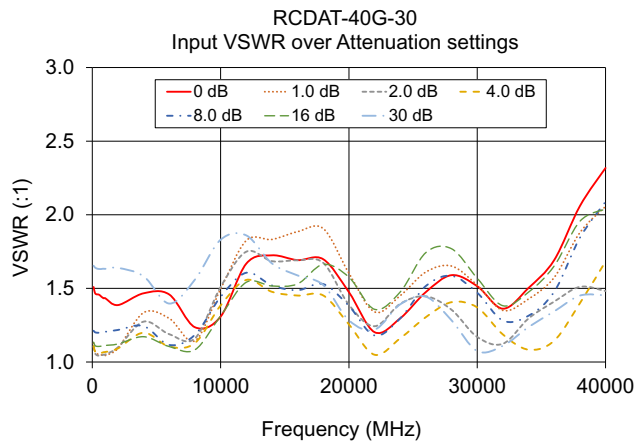
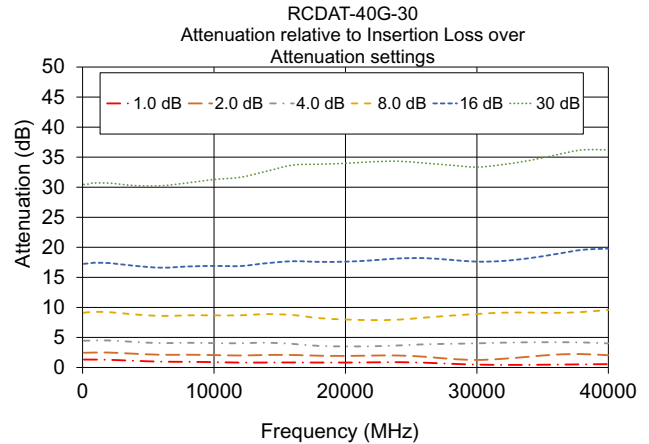
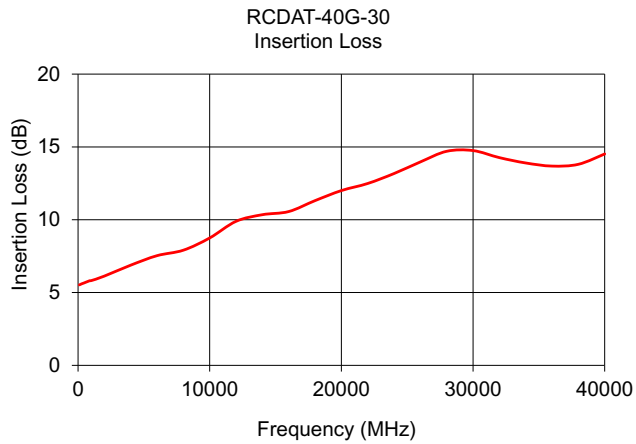



## Typical Performance Data @ +25°C (Mode 1)

Frequency (GHz)	Insertion Loss (dB)	Attenuation relative to Insertion Loss (dB)					
		@ Attenuation setting					
		1 dB	2 dB	4 dB	8 dB	16 dB	30 dB
100	5.53	1.31	2.45	4.46	9.07	17.24	30.45
200	5.57	1.31	2.45	4.46	9.15	17.28	30.48
300	5.61	1.32	2.45	4.46	9.17	17.29	30.45
400	5.64	1.32	2.46	4.47	9.19	17.31	30.51
500	5.67	1.32	2.46	4.47	9.20	17.34	30.56
600	5.71	1.32	2.47	4.48	9.22	17.36	30.63
700	5.75	1.31	2.47	4.49	9.23	17.38	30.67
800	5.78	1.31	2.48	4.50	9.25	17.43	30.77
900	5.81	1.31	2.48	4.50	9.25	17.44	30.78
1000	5.82	1.32	2.48	4.50	9.24	17.40	30.70
2000	6.13	1.28	2.48	4.49	9.21	17.38	30.69
4000	6.88	1.11	2.28	4.24	8.82	16.90	30.27
6000	7.53	0.97	2.11	4.06	8.58	16.61	30.25
8000	7.91	0.94	2.12	4.11	8.68	16.81	30.72
10000	8.75	0.89	2.06	4.05	8.67	16.90	31.29
12000	9.89	0.81	1.99	4.03	8.68	16.88	31.65
14000	10.35	0.83	2.08	4.13	8.88	17.35	32.66
16000	10.56	0.83	2.08	3.92	8.72	17.68	33.68
18000	11.31	0.82	1.96	3.58	8.21	17.58	33.83
20000	12.00	0.82	1.92	3.51	7.98	17.61	33.97
22000	12.49	0.85	1.98	3.53	7.89	17.83	34.23
24000	13.17	0.88	1.99	3.66	7.96	18.14	34.33
26000	13.97	0.80	1.79	3.85	8.30	18.19	34.02
28000	14.70	0.61	1.43	3.94	8.62	17.91	33.67
30000	14.75	0.48	1.25	4.02	8.91	17.61	33.34
32000	14.26	0.43	1.45	4.13	9.12	17.74	33.78
34000	13.90	0.44	1.80	4.19	9.14	18.19	34.45
36000	13.68	0.47	2.14	4.20	9.10	18.87	35.36
38000	13.81	0.52	2.23	4.17	9.23	19.57	36.20
40000	14.52	0.55	2.03	4.00	9.59	19.78	36.20

Frequency (GHz)	VSWR In (:1)							VSWR Out (:1)						
	@ Attenuation setting							@ Attenuation setting						
	0 dB	1 dB	2 dB	4 dB	8 dB	16 dB	30 dB	0 dB	1 dB	2 dB	4 dB	8 dB	16 dB	30 dB
100	1.51	1.13	1.11	1.11	1.21	1.13	1.65	1.84	1.69	1.64	1.49	1.20	1.51	1.53
200	1.47	1.08	1.06	1.07	1.20	1.11	1.64	1.81	1.66	1.61	1.47	1.17	1.51	1.54
300	1.46	1.06	1.05	1.06	1.20	1.11	1.64	1.80	1.65	1.61	1.46	1.16	1.51	1.54
400	1.46	1.05	1.04	1.06	1.20	1.11	1.63	1.79	1.65	1.60	1.46	1.16	1.51	1.54
500	1.46	1.05	1.04	1.06	1.20	1.11	1.63	1.79	1.64	1.60	1.46	1.15	1.51	1.54
600	1.45	1.05	1.04	1.06	1.20	1.11	1.63	1.78	1.64	1.59	1.45	1.15	1.51	1.54
700	1.44	1.05	1.05	1.06	1.20	1.11	1.63	1.78	1.64	1.59	1.45	1.15	1.51	1.54
800	1.44	1.05	1.05	1.06	1.20	1.11	1.63	1.78	1.63	1.59	1.45	1.15	1.51	1.54
900	1.43	1.04	1.05	1.07	1.21	1.11	1.63	1.77	1.63	1.58	1.45	1.15	1.51	1.54
1000	1.43	1.04	1.05	1.07	1.21	1.11	1.63	1.77	1.63	1.58	1.44	1.15	1.52	1.54
2000	1.39	1.09	1.10	1.09	1.22	1.12	1.64	1.71	1.56	1.52	1.39	1.13	1.53	1.55
4000	1.47	1.34	1.27	1.20	1.24	1.17	1.58	1.69	1.58	1.54	1.43	1.17	1.49	1.51
6000	1.46	1.30	1.19	1.10	1.12	1.11	1.40	1.68	1.60	1.58	1.50	1.25	1.35	1.36
8000	1.24	1.14	1.16	1.13	1.18	1.08	1.56	1.47	1.40	1.40	1.37	1.25	1.47	1.48
10000	1.31	1.50	1.51	1.38	1.44	1.31	1.83	1.20	1.18	1.17	1.09	1.09	1.74	1.75
12000	1.67	1.82	1.75	1.56	1.61	1.54	1.86	1.51	1.46	1.44	1.35	1.22	1.81	1.82
14000	1.72	1.83	1.69	1.48	1.52	1.52	1.67	1.60	1.53	1.52	1.42	1.20	1.62	1.63
16000	1.69	1.89	1.69	1.45	1.49	1.53	1.59	1.45	1.50	1.50	1.40	1.16	1.57	1.57
18000	1.70	1.91	1.67	1.45	1.53	1.66	1.52	1.40	1.55	1.58	1.52	1.25	1.58	1.58
20000	1.47	1.60	1.39	1.26	1.38	1.58	1.28	1.30	1.40	1.46	1.49	1.32	1.37	1.37
22000	1.20	1.34	1.24	1.05	1.18	1.36	1.22	1.08	1.12	1.18	1.23	1.21	1.34	1.34
24000	1.30	1.45	1.40	1.16	1.30	1.48	1.39	1.13	1.25	1.30	1.30	1.10	1.60	1.60
26000	1.48	1.61	1.45	1.30	1.52	1.74	1.44	1.30	1.44	1.52	1.59	1.42	1.72	1.71
28000	1.59	1.65	1.35	1.41	1.58	1.77	1.28	1.44	1.54	1.57	1.71	1.65	1.55	1.54
30000	1.51	1.52	1.17	1.37	1.47	1.57	1.07	1.37	1.49	1.45	1.59	1.67	1.30	1.29
32000	1.36	1.35	1.12	1.19	1.28	1.38	1.11	1.09	1.32	1.25	1.37	1.53	1.21	1.21
34000	1.50	1.43	1.30	1.08	1.31	1.47	1.24	1.18	1.26	1.19	1.31	1.49	1.29	1.29
36000	1.69	1.57	1.41	1.14	1.48	1.65	1.34	1.34	1.30	1.23	1.32	1.56	1.36	1.36
38000	2.06	1.88	1.51	1.40	1.84	1.96	1.45	1.54	1.52	1.44	1.45	1.80	1.45	1.45
40000	2.32	2.06	1.48	1.68	2.09	2.04	1.45	1.81	1.83	1.76	1.57	2.08	1.41	1.41

## Typical Performance Curves @+25°C (Mode 2)

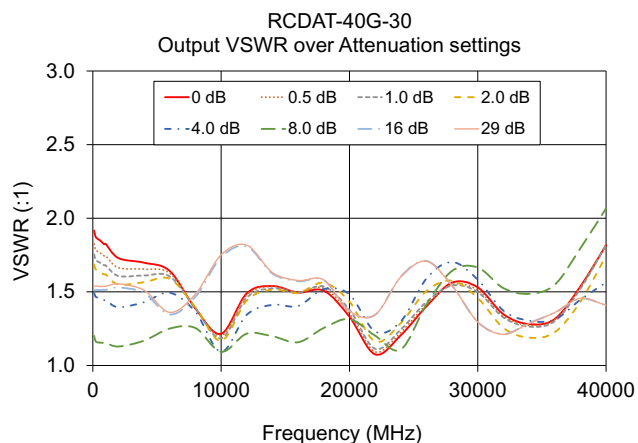
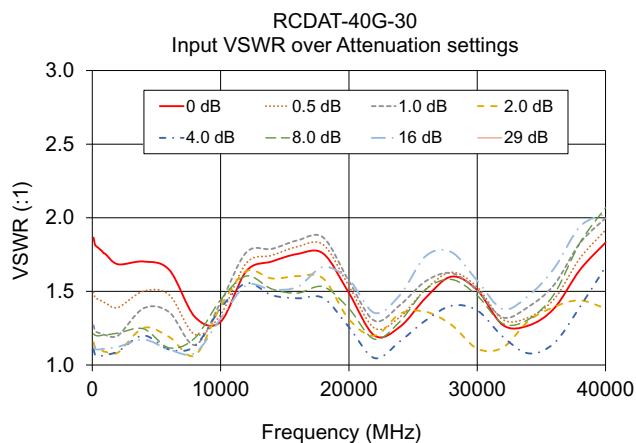
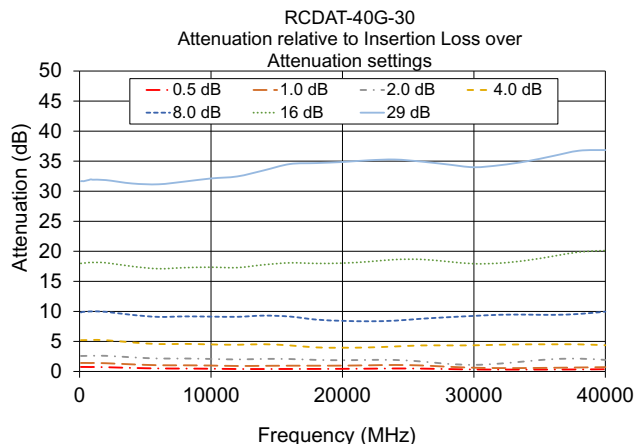
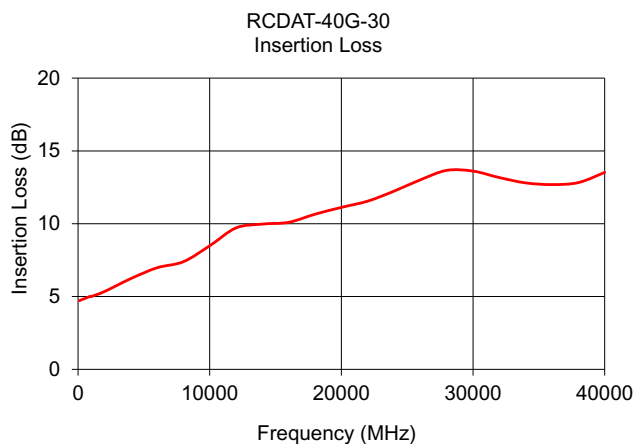

## Typical Performance Data @ +25°C (Mode 2)

Frequency (GHz)	Insertion Loss (dB)	Attenuation relative to Insertion Loss (dB)						
		@ Attenuation setting						
		0.5 dB	1 dB	2 dB	4 dB	8 dB	16 dB	29 dB
100	4.72	0.75	1.41	2.58	5.21	9.82	17.99	31.66
200	4.75	0.75	1.42	2.58	5.21	9.90	18.03	31.69
300	4.79	0.75	1.42	2.59	5.22	9.92	18.03	31.66
400	4.83	0.75	1.42	2.59	5.22	9.94	18.06	31.71
500	4.86	0.75	1.42	2.59	5.22	9.96	18.09	31.77
600	4.90	0.75	1.42	2.60	5.23	9.97	18.11	31.82
700	4.93	0.75	1.41	2.60	5.23	9.97	18.12	31.86
800	4.97	0.74	1.41	2.61	5.24	9.99	18.16	31.94
900	5.01	0.74	1.41	2.61	5.24	9.99	18.17	31.96
1000	5.00	0.75	1.42	2.61	5.25	10.00	18.14	31.91
2000	5.34	0.71	1.37	2.60	5.20	9.93	18.09	31.85
4000	6.23	0.59	1.18	2.35	4.83	9.41	17.49	31.29
6000	6.98	0.50	1.04	2.16	4.56	9.08	17.10	31.15
8000	7.39	0.48	1.03	2.16	4.59	9.16	17.28	31.61
10000	8.49	0.45	0.99	2.08	4.50	9.13	17.35	32.12
12000	9.71	0.41	0.91	2.00	4.44	9.10	17.28	32.46
14000	9.98	0.41	0.94	2.09	4.54	9.29	17.75	33.46
16000	10.10	0.42	0.96	2.07	4.33	9.14	18.08	34.52
18000	10.65	0.42	0.96	1.93	4.00	8.63	17.98	34.68
20000	11.12	0.44	0.97	1.87	3.95	8.43	18.03	34.86
22000	11.55	0.47	1.03	1.92	4.00	8.35	18.28	35.14
24000	12.24	0.50	1.08	1.92	4.16	8.46	18.63	35.27
26000	13.02	0.48	1.00	1.67	4.33	8.78	18.65	34.93
28000	13.66	0.40	0.79	1.27	4.34	9.03	18.29	34.45
30000	13.61	0.34	0.63	1.10	4.35	9.25	17.93	33.99
32000	13.17	0.32	0.56	1.32	4.45	9.44	18.03	34.33
34000	12.80	0.32	0.57	1.70	4.51	9.46	18.48	34.97
36000	12.69	0.32	0.61	2.05	4.52	9.42	19.17	35.85
38000	12.82	0.34	0.67	2.14	4.51	9.57	19.88	36.74
40000	13.52	0.37	0.72	1.92	4.37	9.96	20.12	36.85

Frequency (GHz)	VSWR In (:1)								VSWR Out (:1)							
	@ Attenuation setting								@ Attenuation setting							
	0 dB	0.5 dB	1 dB	2 dB	4 dB	8 dB	16 dB	29 dB	0 dB	0.5 dB	1 dB	2 dB	4 dB	8 dB	16 dB	29 dB
100	1.87	1.49	1.27	1.15	1.11	1.21	1.13	1.79	1.92	1.83	1.75	1.69	1.49	1.20	1.51	1.54
200	1.82	1.46	1.23	1.12	1.07	1.20	1.11	1.78	1.88	1.79	1.72	1.66	1.47	1.17	1.51	1.54
300	1.81	1.45	1.23	1.11	1.06	1.20	1.11	1.77	1.87	1.78	1.71	1.65	1.46	1.16	1.51	1.54
400	1.80	1.45	1.22	1.11	1.06	1.20	1.11	1.76	1.86	1.77	1.71	1.64	1.46	1.16	1.51	1.54
500	1.79	1.44	1.22	1.11	1.06	1.20	1.11	1.76	1.85	1.77	1.70	1.64	1.46	1.16	1.51	1.54
600	1.79	1.44	1.22	1.10	1.06	1.20	1.11	1.76	1.85	1.76	1.70	1.63	1.45	1.16	1.51	1.54
700	1.78	1.44	1.21	1.10	1.06	1.20	1.11	1.76	1.84	1.76	1.69	1.63	1.45	1.15	1.51	1.54
800	1.77	1.43	1.21	1.10	1.06	1.20	1.11	1.76	1.83	1.75	1.68	1.62	1.45	1.15	1.51	1.54
900	1.76	1.43	1.21	1.09	1.07	1.20	1.11	1.76	1.82	1.74	1.68	1.62	1.44	1.15	1.51	1.54
1000	1.76	1.42	1.20	1.09	1.07	1.20	1.11	1.76	1.83	1.74	1.68	1.62	1.44	1.15	1.51	1.54
2000	1.68	1.39	1.20	1.08	1.09	1.22	1.12	1.76	1.73	1.66	1.61	1.55	1.40	1.13	1.53	1.55
4000	1.70	1.50	1.39	1.25	1.20	1.25	1.17	1.70	1.70	1.65	1.61	1.57	1.43	1.17	1.49	1.51
6000	1.65	1.48	1.36	1.19	1.11	1.12	1.11	1.50	1.64	1.63	1.60	1.59	1.49	1.25	1.35	1.36
8000	1.33	1.21	1.14	1.07	1.13	1.18	1.08	1.64	1.39	1.39	1.39	1.40	1.36	1.25	1.47	1.49
10000	1.29	1.34	1.42	1.40	1.38	1.44	1.31	1.93	1.22	1.20	1.18	1.17	1.09	1.09	1.74	1.75
12000	1.64	1.69	1.76	1.64	1.56	1.60	1.54	1.97	1.49	1.48	1.46	1.44	1.34	1.22	1.81	1.82
14000	1.70	1.74	1.79	1.59	1.47	1.52	1.51	1.76	1.54	1.54	1.52	1.51	1.41	1.20	1.62	1.63
16000	1.75	1.80	1.85	1.60	1.45	1.49	1.53	1.67	1.49	1.50	1.49	1.49	1.40	1.16	1.57	1.58
18000	1.76	1.82	1.87	1.59	1.45	1.53	1.67	1.60	1.51	1.52	1.54	1.56	1.52	1.26	1.58	1.58
20000	1.49	1.54	1.57	1.31	1.26	1.38	1.58	1.35	1.33	1.35	1.38	1.43	1.48	1.32	1.37	1.37
22000	1.20	1.25	1.30	1.20	1.05	1.18	1.35	1.26	1.08	1.09	1.11	1.16	1.23	1.20	1.34	1.34
24000	1.26	1.33	1.41	1.35	1.16	1.30	1.48	1.44	1.21	1.22	1.24	1.29	1.30	1.11	1.60	1.60
26000	1.46	1.52	1.57	1.36	1.30	1.51	1.74	1.50	1.40	1.41	1.43	1.51	1.59	1.41	1.71	1.71
28000	1.60	1.63	1.62	1.27	1.40	1.58	1.77	1.34	1.56	1.55	1.54	1.58	1.70	1.64	1.54	1.54
30000	1.51	1.53	1.51	1.11	1.37	1.47	1.57	1.12	1.53	1.51	1.50	1.46	1.58	1.67	1.29	1.30
32000	1.27	1.31	1.32	1.12	1.19	1.28	1.38	1.10	1.35	1.34	1.33	1.26	1.37	1.53	1.21	1.21
34000	1.27	1.32	1.40	1.30	1.08	1.31	1.47	1.25	1.28	1.27	1.26	1.19	1.30	1.49	1.29	1.29
36000	1.39	1.45	1.55	1.39	1.15	1.48	1.66	1.36	1.32	1.31	1.30	1.23	1.31	1.55	1.36	1.36
38000	1.65	1.72	1.83	1.44	1.39	1.83	1.94	1.48	1.54	1.53	1.52	1.43	1.45	1.80	1.45	1.46
40000	1.83	1.92	2.00	1.38	1.67	2.07	2.03	1.50	1.82	1.82	1.82	1.75	1.56	2.07	1.41	1.41

## Software & Documentation Download:

- Mini-Circuits' full software and support package including user guide, Windows GUI, DLL files, programming manual and examples can be downloaded free of charge from <http://www.minicircuits.com/softwaredownload/patt.html>
- Please contact [testsolutions@minicircuits.com](mailto:testsolutions@minicircuits.com) for support

## Minimum System Requirements

Parameter	Requirements	
Interface	USB HID or HTTP Get/Post or Telnet protocols	
System requirements	GUI:	Windows 32 & 64 bit systems from Windows 98 up to Windows 10
	USB API (ActiveX & .Net)	Windows 32 & 64 bit systems with ActiveX or .Net support from Windows 98 up to Windows 10
	USB direct programming support	Linux, Windows systems from Windows 98 up to Windows 10
	HTTP or Telnet	Any computer with a network port and Ethernet-TCP/IP (HTTP or Telnet protocols) support
Hardware	Pentium® II or higher, RAM 256 MB	

## Graphical User Interface (GUI) for Windows

### Key Features:

- Manual attenuation setting
- Sweep and Hop attenuation sequences directed from the PC, or entire sequence loaded into RCDAT.
- Attenuator address configuration and Firmware upgrade
- Attenuation at power up may be set to selected attenuation level or last attenuation state recorded.
- Controlling up to 25 RCDAT units in 'daisy chain' configuration.
- USB, HTTP or Telnet control of RCDAT
- Setting Ethernet configuration

## Application Programming Interface (API)

Programming manual: [https://www.minicircuits.com/softwaredownload/Prog\\_Manual-6-Programmable\\_Attenuator.pdf](https://www.minicircuits.com/softwaredownload/Prog_Manual-6-Programmable_Attenuator.pdf)

### Windows Support:

- API DLL files exposing the full switch functionality
  - ActiveX COM DLL file for creation of 32-bit programs
  - .Net library DLL file for creation of 32 / 64-bit programs
- Supported by most common programming environments (refer to application note [AN-49-001](#) for summary of tested environments)

### Linux Support:

- Full attenuator control in a Linux environment is achieved by way of USB interrupt commands.

## Ordering Information

Model	Description
RCDAT-40G-30	USB / Ethernet Programmable Attenuator

Included Accessories	Part No.	Description
	MUSB-CBL-3+	2.6 ft (0.8 m) USB Cable: USB type A(Male) to USB type Mini-B(Male)

Optional Accessories	Description
USB-AC/DC-5+	AC/DC 5V <sub>DC</sub> Power Adapter with US, EU, IL, UK, AUS, and China power plugs <sup>9,10</sup>
MUSB-CBL-3+ (spare)	2.6 ft (0.8 m) USB Cable: USB type A(Male) to USB type Mini-B(Male)
MUSB-CBL-AB-7+	6.6 ft (2.0 m) USB Cable: USB type A(Male) to USB type Mini-B(Male)
CBL-RJ45-MM-5+	5 ft (1.5 m) Ethernet cable: RJ45(Male) to RJ45(Male) Cat 5E cable
CBL-1.5FT-MMD+	1.5 ft (0.5 m) Digital Snap Fit(male-male) cable assembly(daisy chain)
CBL-5FT-MMD+	5 ft (1.5 m) Digital Snap Fit(male-male) cable assembly(daisy chain)

<sup>9</sup> The USB-AC/DC-5 may be used to provide the 5V<sub>DC</sub> power input via USB port if operating the RCDAT with Ethernet control. Not required if using USB control.

<sup>10</sup> Power plugs for other countries are also available, Plugs for other countries are also available, if you need a power plug for a country not listed please contact [testsolutions@minicircuits.com](mailto:testsolutions@minicircuits.com)

## Additional Notes

- A. Performance and quality attributes and conditions not expressly stated in this specification document are intended to be excluded and do not form a part of this specification document.
- B. Electrical specifications and performance data contained in this specification document are based on Mini-Circuit's applicable established test performance criteria and measurement instructions.
- C. The parts covered by this specification document are subject to Mini-Circuits standard limited warranty and terms and conditions (collectively, "Standard Terms"); Purchasers of this part are entitled to the rights and benefits contained therein. For a full statement of the Standard Terms and the exclusive rights and remedies thereunder, please visit Mini-Circuits' website at [www.minicircuits.com/MCLStore/terms.jsp](http://www.minicircuits.com/MCLStore/terms.jsp)

