

# Programmable Attenuator

RCDAT-8000-30

50Ω 0 – 30 dB, 0.25 dB step 1 to 8000 MHz

## The Big Deal

- Supports U-NII bands 5-8 (5.925 to 7.125 GHz)
- Fine attenuation resolution, 0.25 dB
- Automation via Ethernet & USB



Software Package

Case Style: MS1897

## Applications

- Wi-Fi 6E MIMO development
- LTE / 5G / IoT / Bluetooth / Zigbee
- Cellular handover testing
- C-band radar / satcom testing
- Automated signal sweeping / fading

### Included Accessories

Model No.	Description	Qty.
MUSB-CBL-3+	2.6 ft. USB cable	1

### RoHS Compliant

See our web site for RoHS Compliance methodologies and qualifications

## Product Overview

Mini-Circuits' RCDAT-8000-30 is a general purpose, single channel programmable attenuator suitable for a wide range of signal level control applications from 1 MHz to 8 GHz. The Attenuator provides 0 to 30 dB attenuation in 0.25 dB steps. Its unique design maintains linear attenuation change per dB, even at the highest attenuation settings.

The attenuator is housed in a compact and rugged package with SMA female connectors on the bi-directional input and output RF ports, a standard Ethernet port (RJ45) and a USB type Mini-B power and control port.

The attenuator can be controlled via USB or Ethernet (supporting both HTTP and Telnet network protocols). Full software support is provided and can be downloaded from our website any time at <http://www.minicircuits.com/softwaredownload/patt.html>. The package includes our user-friendly GUI application for Windows® and a full API with programming instructions for Windows® and Linux® environments (both 32-bit and 64-bit systems).

## Key Features

Feature	Advantages
USB & Ethernet control	USB HID and Ethernet (HTTP / Telnet) interfaces provide easy compatibility with a wide range of software setups and programming environments
Programmable attenuation sweep and Hop sequences	The RCDAT-8000-30 can be programmed with a timed sequence of attenuation settings, to run without any additional external control.
30 dB attenuation range.	The RCDAT-8000-30 provides high-accuracy attenuation up to 30 dB in 0.25 dB steps, allowing the user precise level control over a broad attenuation and frequency range.
High linearity	Typical input IP3 of +52 dBm up to 8000 MHz.

**Trademarks:** Windows is a registered trademark of Microsoft Corporation in the United States and other countries. Linux is a registered trademark of Linus Torvalds. Mac is a registered trademark of Apple Corporation. Pentium is a registered trademark of Intel Corporation. Neither Mini-Circuits nor the Mini-Circuits RCDAT-series attenuators are affiliated with or endorsed by the owners of the above referenced trademarks.

Mini-Circuits and the Mini-Circuits logo are registered trademarks of Scientific Components Corporation.



## Electrical Specifications <sup>1</sup> at 0°C to 50°C

Parameter	Frequency range	Conditions	Min.	Typ.	Max.	Units
Attenuation range	1 - 8000 MHz	0.25 dB step	0	-	30	dB
Attenuation accuracy <sup>2</sup>	1 - 2000 MHz	@ 0.25 - 30 dB	-	±0.20	±(0.20+2% of nominal value)	dB
	2000 - 4000 MHz	@ 0.25 - 15.75 dB	-	±0.10	±(0.25+2% of nominal value)	
		@ 16 - 30 dB	-	±0.30	±(0.25+3% of nominal value)	
	4000 - 6000 MHz	@ 0.25 - 15.75 dB	-	±0.30	±(0.30+3.5% of nominal value)	
		@ 16 - 30 dB	-	±1.00	±(0.65+4.5% of nominal value)	
6000 - 8000 MHz	@ 0.25 - 15.75 dB	-	±0.40	±(0.60+4% of nominal value)		
Insertion Loss	1 - 2000 MHz	@ 0 dB	-	1.4	2.5	dB
	2000 - 4000 MHz		-	2.5	4.0	
	4000 - 6000 MHz		-	3.4	5.0	
	6000 - 8000 MHz		-	4.3	6.0	
Isolation In-Out	1 - 8000 MHz	Note 3	-	34	-	dB
Input operating power <sup>4</sup> (RF In and RF Out ports)	1 - 50 MHz	@ 0 - 30 dB	-	-	Note 5	dBm
	50 - 8000 MHz		-	-	+28	
IP3 Input <sup>6</sup>	1 - 5000 MHz	@ 0 dB setting (P <sub>IN</sub> =+5 dBm)	-	+53	-	dBm
	5000 - 8000 MHz		-	+49	-	
VSWR	1 - 4000 MHz	@ 0 - 30 dB	-	1.25	-	:1
	4000 - 8000 MHz		-	1.50	-	
Min Dwell Time <sup>7</sup>	1 - 8000 MHz	High speed mode	-	600	-	µsec
Attenuation Transition Time <sup>8</sup>	1 - 8000 MHz	-	-	800	-	nsec
Supply Voltage	-	via USB port	4.75	5	5.25	V
USB current draw	-	-	-	190	250	mA
Ethernet communication	Supports both Telnet and HTTP protocols over TCP/IP with dynamic(DHCP) or static IP					

<sup>1</sup> Attenuator RF ports are interchangeable, and support simultaneous, bidirectional signal transmission, however the specifications are guaranteed for the RF in and RF out as noted on the label. There may be minor changes in performance when injecting signals to the RF Out port.

<sup>2</sup> Max accuracy defined as ±[absolute error+% of attenuation setting] for example when setting the attenuator to 26 dB attenuation the maximum error at 7500 MHz will be: ±(1.45+0.035x26)= ±(1.45+9.1)= ± 2.35 dB

<sup>3</sup> Isolation is defined as max attenuation plus insertion loss; this is the path loss through the attenuator when initially powered up. After a brief delay (~0.5 sec typically) the attenuator will revert to a user defined "power-up" state (either max attenuation or a pre-set value).

<sup>4</sup> Total operating input power from both RF In and RF Out ports. Compression level not noted as it exceeds max safe operating power level.

<sup>5</sup> Derate linearly from +28 dBm at 50 MHz to +17 dBm at 1MHz

<sup>6</sup> Tested with 1 MHz span between signals.

<sup>7</sup> Minimum Dwell Time is the time the RCDAT will take to respond to a command to change attenuation states without communication delays. In PC control add communication delays (on the order of msec for USB) to get actual response time.

<sup>8</sup> Attenuation Transition Time is specified as the time between starting to change the attenuation state and settling on the requested attenuation state.

## Absolute Maximum Ratings

Operating Temperature	0°C to 50°C	
Storage Temperature	-20°C to 85°C	
V <sub>USB</sub> Max.	6V	
DC voltage at RF port	16V	
Total RF power for RF In & RF Out	@ 1 - 50 MHz	Derates linearly from +33 @ 50 MHz to +20 @ 1 MHz
	@ 50 - 8000 MHz	+33 dBm

Permanent damage may occur if any of these limits are exceeded. Operating in the range between operating power limits and absolute maximum ratings for extended periods of time may result in reduced life and reliability.

## RCDAT response to communication interrupt

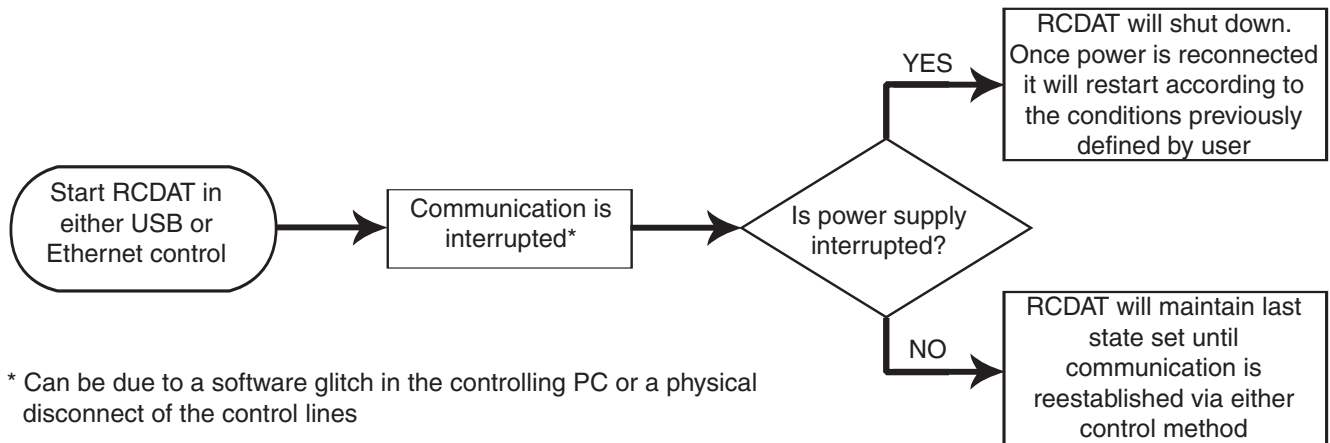

## Block Diagram

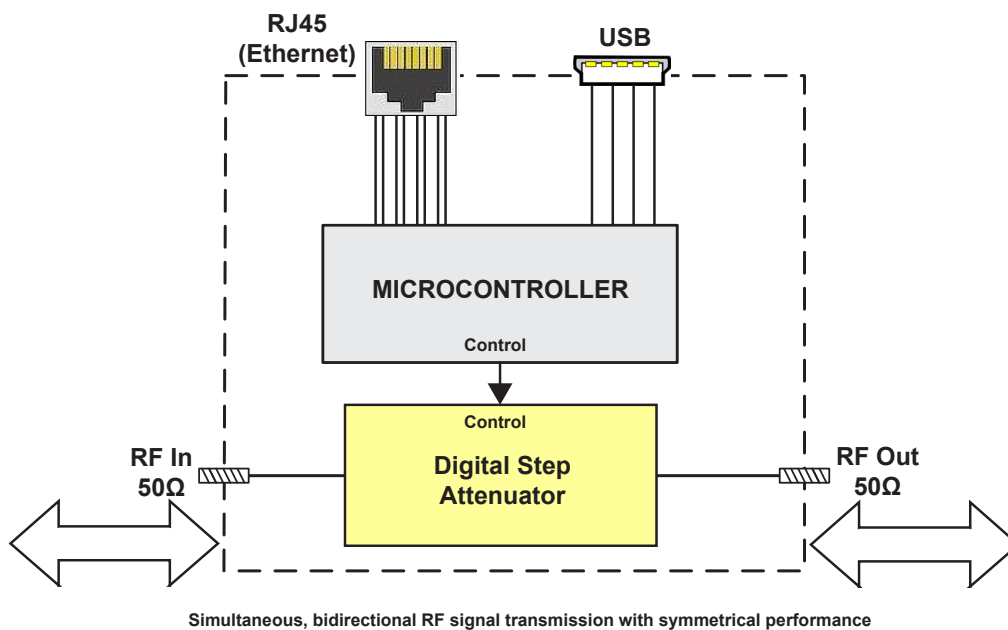

## Connections

RF In	(SMA female)
RF Out	(SMA female)
USB	(USB type Mini-B female)
Network (Ethernet/LAN)	(RJ45 socket)

## Outline Drawing (MS1897)

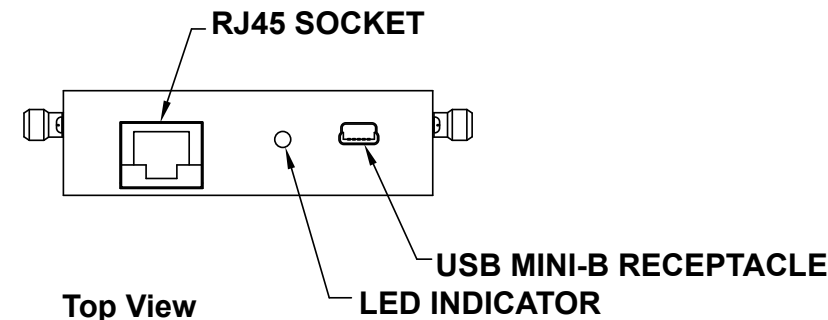

**Top View**

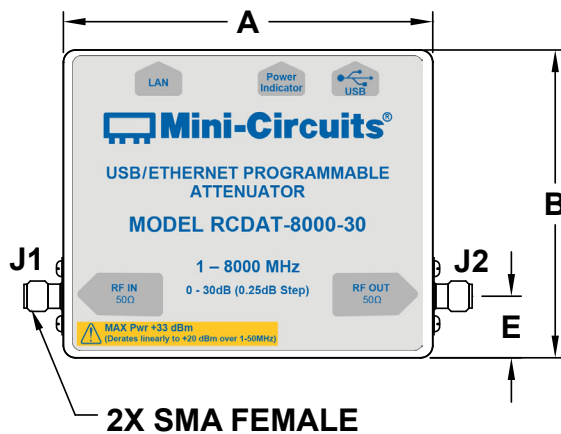

**2X SMA FEMALE**

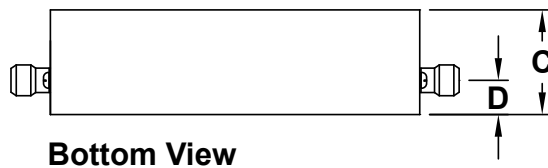

**Bottom View**

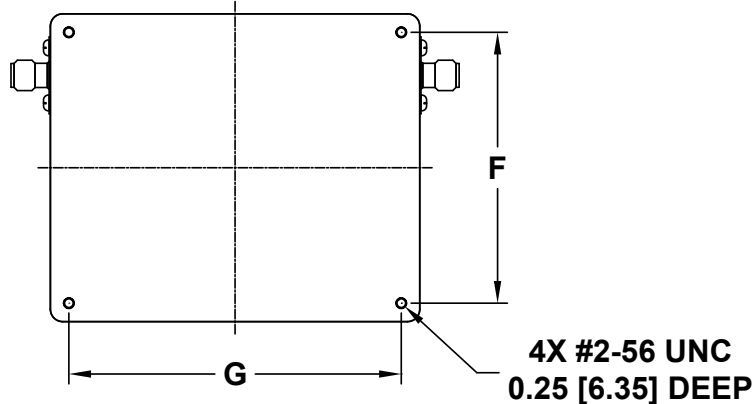

## Connections

RF IN	(SMA female)
RF OUT	(SMA female)
USB	(USB type Mini-B female)
Network (Ethernet/LAN)	(RJ45 socket)

## Bracket Option

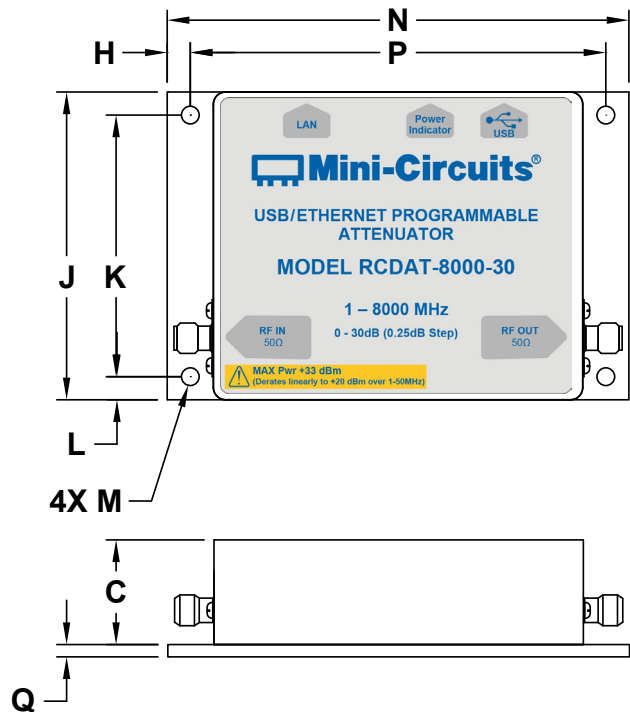

Instruction for mounting bracket:

1. Tool required: Phillips head screwdriver
2. Mount the bracket over threaded holes on the bottom side with the fasteners provided with the bracket.

## Outline Dimensions (inch/mm)

A	B	C	D	E	F	G	H	J	K	L	M	N	P	Q	WT. GRAMS
3.00	2.50	0.85	0.28	0.50	2.200	2.700	0.188	2.50	2.125	0.188	0.144	3.75	3.375	0.100	200
76.2	63.5	21.6	7.1	12.7	55.88	68.58	4.76	63.5	53.98	4.76	3.66	95.3	85.72	2.54	

## Typical Performance Curves

**Attenuation Accuracy @ +25°C vs. Frequency over Attenuation settings**

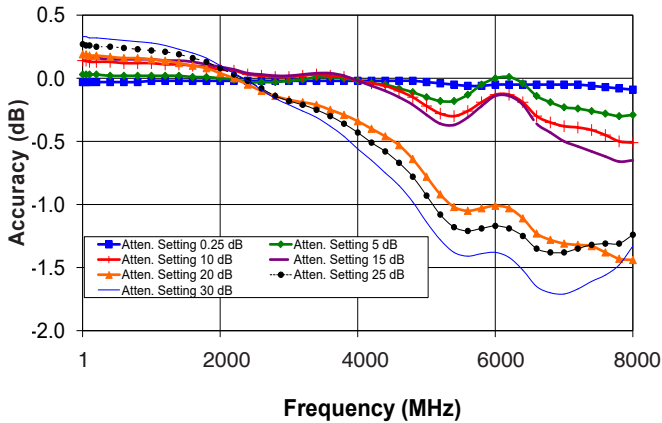

**Attenuation relative to Insertion Loss @ +25°C vs. Frequency over Attenuation settings**

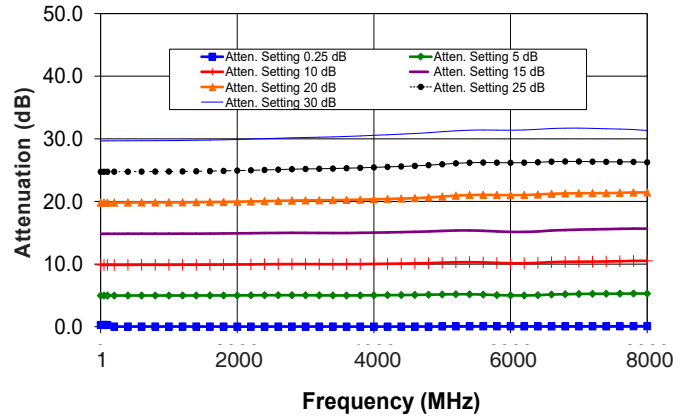

**Attenuation Accuracy @ 0°C vs. Frequency over Attenuation settings**

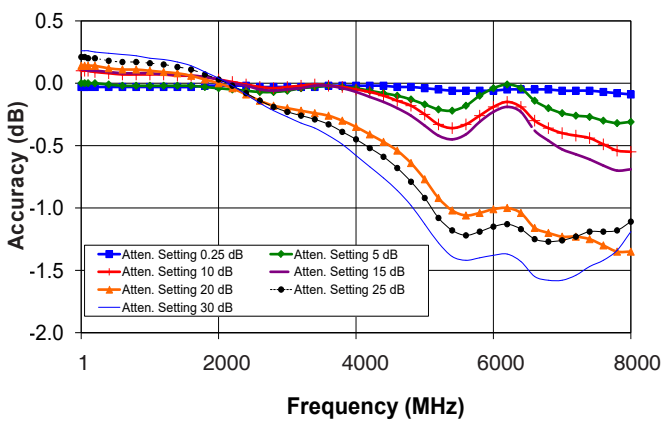

**Attenuation relative to Insertion Loss @ 0°C vs. Frequency over Attenuation settings**

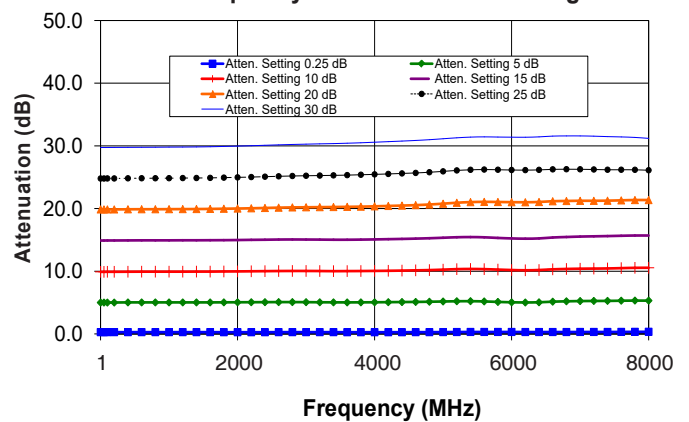

**Attenuation Accuracy @ +50°C vs. Frequency over Attenuation settings**

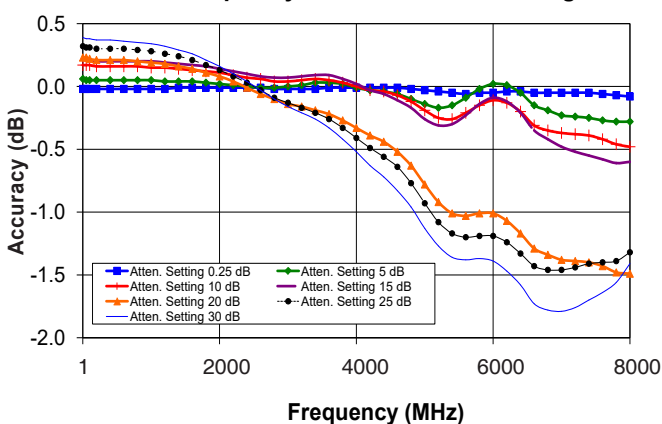

**Attenuation relative to Insertion Loss @ +50°C vs. Frequency over Attenuation settings**

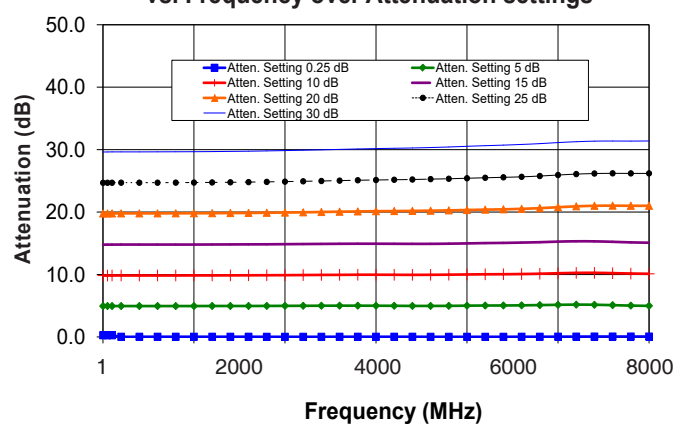

## Typical Performance Curves (Continued)

**Insertion Loss @ Input Power 0dBm vs. Frequency over Temperatures**

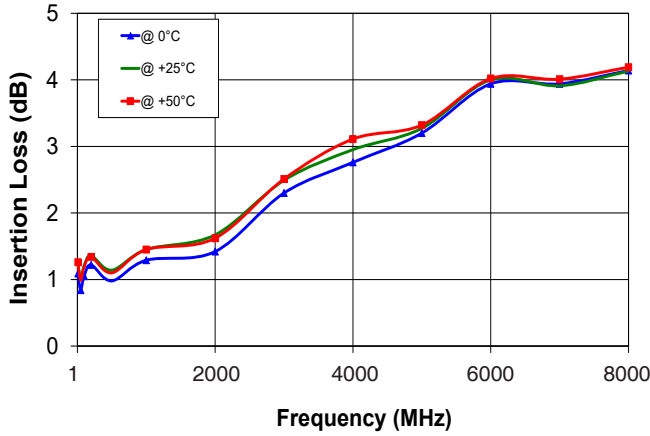

**Insertion Loss @ Input Power +28 dBm vs. Frequency over Temperatures**

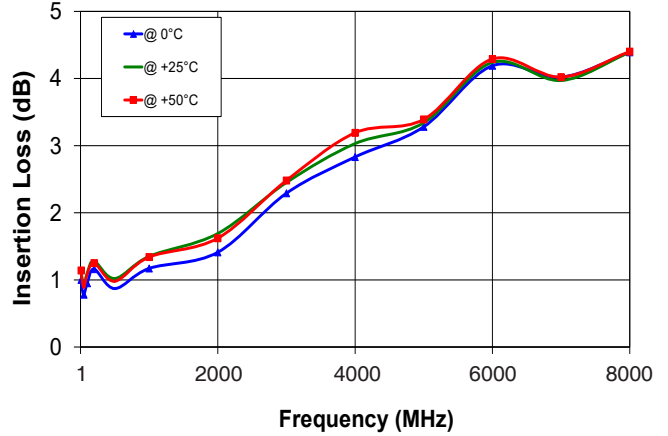

**Output VSWR @ +25°C vs. Frequency over Attenuation settings**

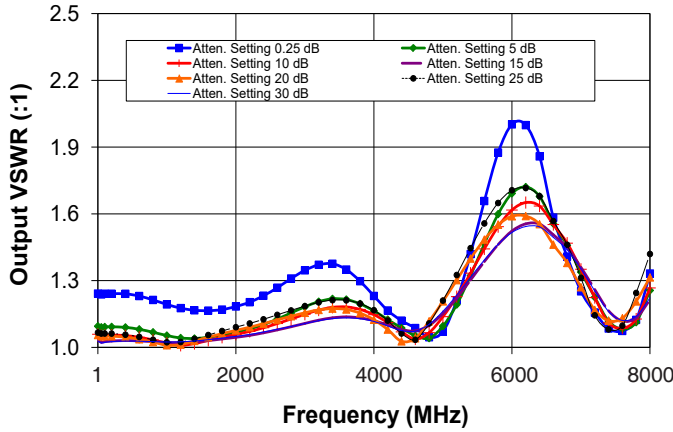

**Input VSWR @ +25°C vs. Frequency over Attenuation settings**

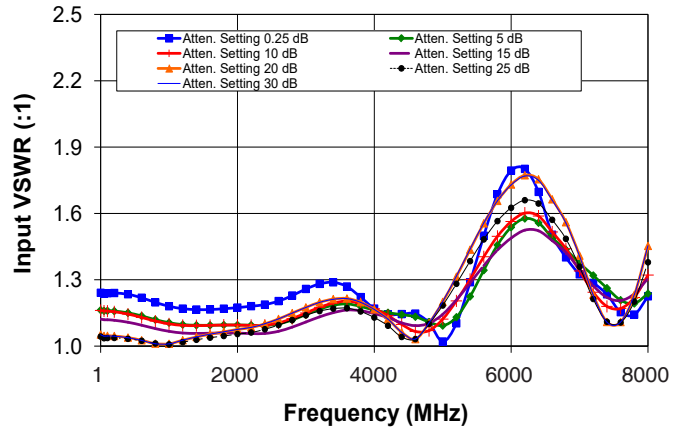

**Input IP3 @ 0dB Attenuation vs. Frequency over Temperatures**

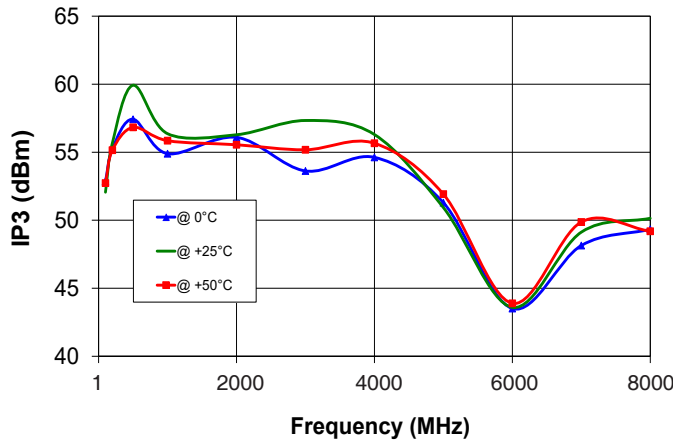

**Typical Attenuation Accuracy vs. Attenuation settings over Temperature**

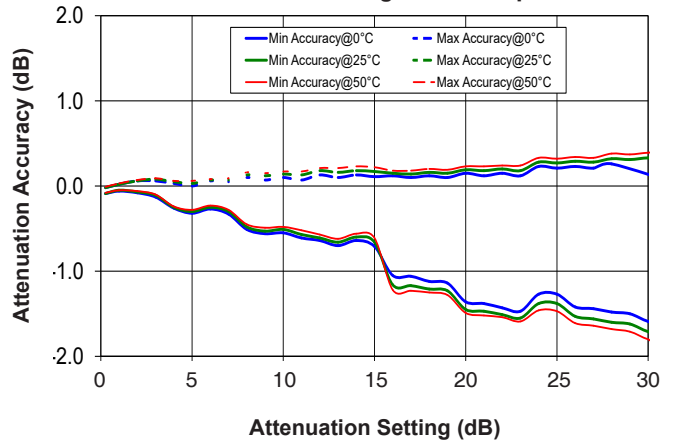

## Software & Documentation Download:

- Mini-Circuits' full software and support package including user guide, Windows GUI, DLL files, programming manual and examples can be downloaded free of charge from <http://www.minicircuits.com/softwaredownload/patt.html>
- Please contact [testsolutions@minicircuits.com](mailto:testsolutions@minicircuits.com) for support

## Minimum System Requirements

Parameter	Requirements	
Interface	USB HID or HTTP Get/Post or Telnet protocols	
System requirements	GUI:	Windows 32 & 64 bit systems from Windows 98 up to Windows 10
	USB API (ActiveX & .Net)	Windows 32 & 64 bit systems with ActiveX or .Net support from Windows 98 up to Windows 10
	USB direct programming support	Linux, Windows systems from Windows 98 up to Windows 10
	HTTP or Telnet	Any computer with a network port and Ethernet-TCP/IP (HTTP or Telnet protocols) support
Hardware	Pentium® II or higher, RAM 256 MB	

## Graphical User Interface (GUI) for Windows

### Key Features:

- Manual attenuation setting
- Sweep and Hop attenuation sequences directed from the PC, or entire sequence loaded into RCDAT.
- Attenuator address configuration and Firmware upgrade
- Attenuation at power up may be set to selected attenuation level or last attenuation state recorded.
- USB, HTTP or Telnet control of RCDAT
- Setting Ethernet configuration

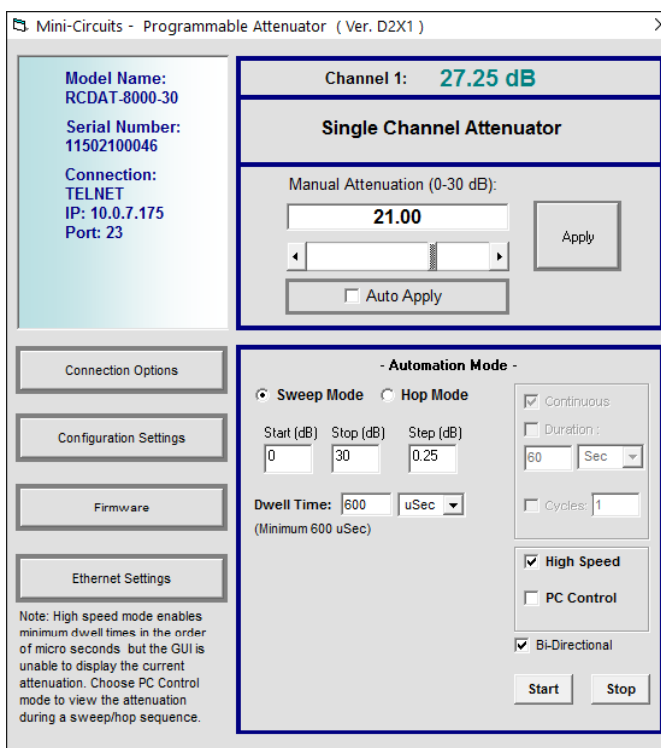

## Application Programming Interface (API)

Programming manual: [https://www.minicircuits.com/softwaredownload/Prog\\_Manual-6-Programmable\\_Attenuator.pdf](https://www.minicircuits.com/softwaredownload/Prog_Manual-6-Programmable_Attenuator.pdf)

### Windows Support:

- API DLL files exposing the full switch functionality
  - ActiveX COM DLL file for creation of 32-bit programs
  - .Net library DLL file for creation of 32 / 64-bit programs
- Supported by most common programming environments (refer to application note [AN-49-001](#) for summary of tested environments)

### Linux Support:

- Full attenuator control in a Linux environment is achieved by way of USB interrupt commands.

## Ordering Information

Model	Description
RCDAT-8000-30	USB / Ethernet Programmable Attenuator

Included Accessories	Part No.	Description
	MUSB-CBL-3+	2.6 ft (0.8 m) USB Cable: USB type A(Male) to USB type Mini-B(Male)

Optional Accessories	Description
USB-AC/DC-5 <sup>9,10</sup>	AC/DC 5V <sub>DC</sub> Power Adapter with US, EU, IL, UK, AUS, and China power plugs
MUSB-CBL-3+ (spare)	2.6 ft (0.8 m) USB Cable: USB type A(Male) to USB type Mini-B(Male)
MUSB-CBL-7+	6.6 ft (2.0 m) USB Cable: USB type A(Male) to USB type Mini-B(Male)
CBL-RJ45-MM-5+	5 ft (1.5 m) Ethernet cable: RJ45(Male) to RJ45(Male) Cat 5E cable
BKT-66-02+	Bracket Kit

<sup>9</sup> The USB-AC/DC-5 may be used to provide the 5V<sub>DC</sub> power input via USB port if operating the RCDAT with Ethernet control. Not required if using USB control.

<sup>10</sup> Power plugs for other countries are also available, Plugs for other countries are also available, if you need a power plug for a country not listed please contact [testsolutions@minicircuits.com](mailto:testsolutions@minicircuits.com)

## Additional Notes

- A. Performance and quality attributes and conditions not expressly stated in this specification document are intended to be excluded and do not form a part of this specification document.
- B. Electrical specifications and performance data contained in this specification document are based on Mini-Circuit's applicable established test performance criteria and measurement instructions.
- C. The parts covered by this specification document are subject to Mini-Circuits standard limited warranty and terms and conditions (collectively, "Standard Terms"); Purchasers of this part are entitled to the rights and benefits contained therein. For a full statement of the Standard Terms and the exclusive rights and remedies thereunder, please visit Mini-Circuits' website at [www.minicircuits.com/MCLStore/terms.jsp](http://www.minicircuits.com/MCLStore/terms.jsp)

