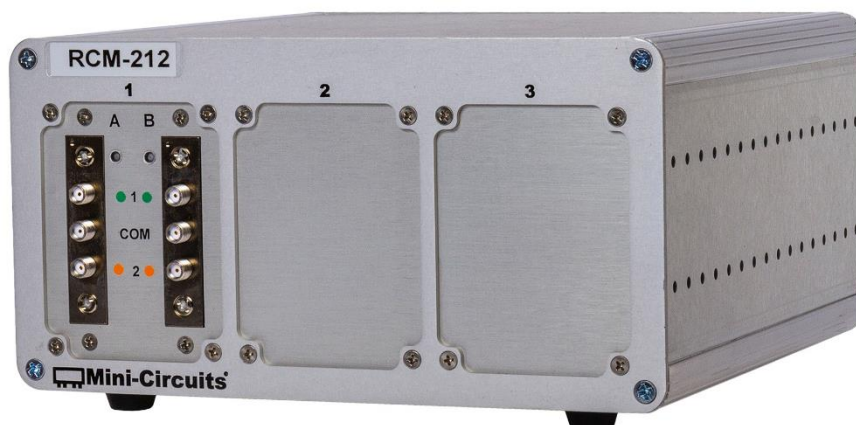

USB & Ethernet Controlled

Multi-Function Switch System

RCM-212

Switch Configuration

Window	Model Name	Frequency	Description
1	MSP2TA-18XL+	DC to 18 GHz	Dual SPDT Switches (Absorptive)
2	None	None	Blank Window
3	None	None	Blank Window

Refer to www.minicircuits.com for full switch component specifications

Mechanical Specifications

Dimensions	8.25" (w) x 4.25" (h) x 8.25" (d); mounting feet add 0.28" height
Case Material	Aluminum (with protective coatings to prevent corrosion)
Case Drawing	99-01-2068
RF Connectors	SMA female
Front Panel	a) All RF ports b) LED switch position indicators
Rear Panel	a) Power ON/OFF switch with indicator light b) 2.1 mm center positive DC socket c) 24 V DC Input d) USB & RJ45 control connections
Control Interface	USB and Ethernet TCP/IP supporting HTTP and TELNET protocols
Power Supply	24V DC input (using provided AC/DC adapter)
Operating Temperature	0° to +50° C

Included Accessories

Model Name	Quantity	Description
CBL-3W1-xx*	1	AC power cord
AC/DC-24-3W1	1	AC / DC adapter
USB-CBL-AB-7+	1	USB cable (6.8 ft)
CBL-RJ45-MM-5+	1	Ethernet cable (5 ft)

*Please specify one option on the purchase order, at no charge

Cable Model	Region
CBL-3W1-US	USA
CBL-3W1-EU	Europe
CBL-3W1-IL	Israel
CBL-3W1-UK	UK
CBL-3W1-AU	Australia / China

Contact testsolutions@minicircuits.com for more information



USB & Ethernet Controlled Multi-Function Switch System

RCM-212

Software Specifications

Software & Documentation Download:

- Mini-Circuits' full software and support package including user guide, Windows GUI, DLL files, programming manual and examples can be downloaded free of charge from https://www.minicircuits.com/softwaredownload/ztm_rcm.html
- Please contact testsolutions@minicircuits.com for support

Minimum System Requirements:

Parameter	Requirements	
Interface	USB HID & Ethernet (HTTP & Telnet)	
System Requirements	GUI	Windows 98 or later
	USB API DLL	Windows 98 or later and programming environment with ActiveX or .NET support
	USB Direct Programming	Linux; Windows 98 or later
	Ethernet	Windows, Linux or Mac computer with a network port and Ethernet TCP / IP support
Hardware	Pentium II or later with 256 MB RAM	

Application Programming Interface (API)

Ethernet Support:

- Simple ASCII / SCPI command set for attenuator control
- Communication via HTTP or Telnet
- Supported by most common programming environments

USB Support (Windows):

- ActiveX COM DLL file for creation of 32-bit programs
- .NET library DLL file for creation of 32 / 64-bit programs
- Supported by most common programming environments (refer to application note [AN-49-001](#) for summary of supported environments)

USB Support (Linux):

- Direct USB programming using a series of USB interrupt codes

Full programming instructions and examples available for a wide range of programming environments / languages.

USB & Ethernet Controlled
Multi-Function Switch System

RCM-212

Case Drawings

Rear Panel

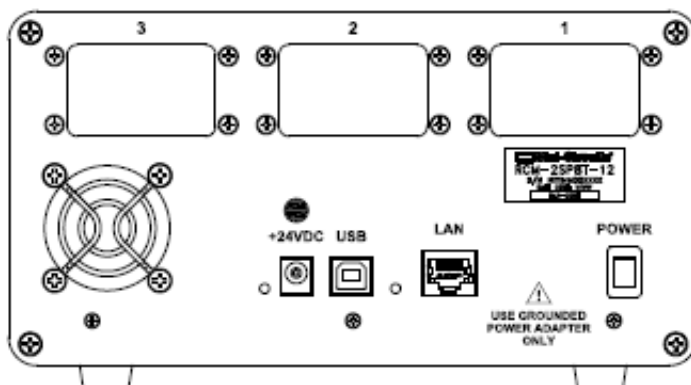

Front Panel (SP8T Switch Options)

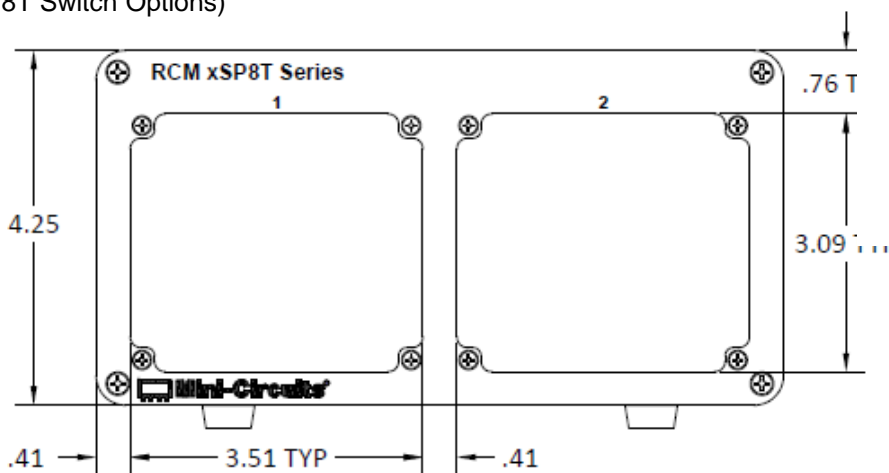

Front Panel (SPDT, SP4T, SP6T & Transfer Switch Options)

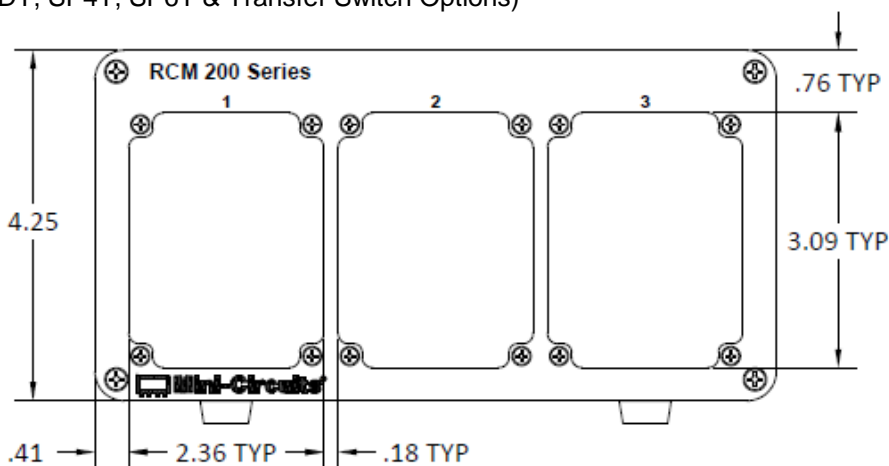

USB & Ethernet Controlled Multi-Function Switch System

RCM-212

Case Drawings

Bottom, Side & Top Panels

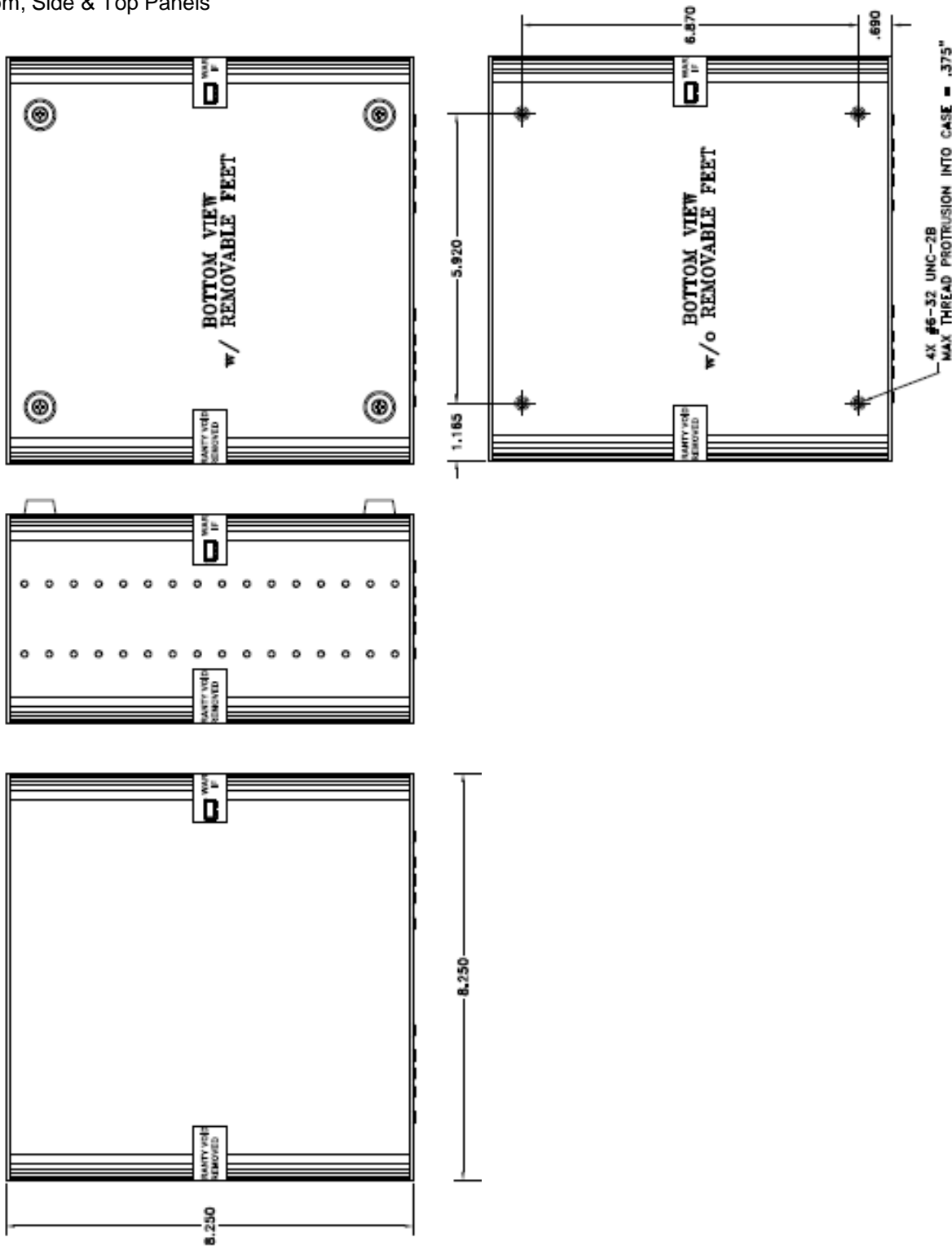

USB & Ethernet Controlled Multi-Function Switch System

RCM-212

Case Drawings

Switch Window Options

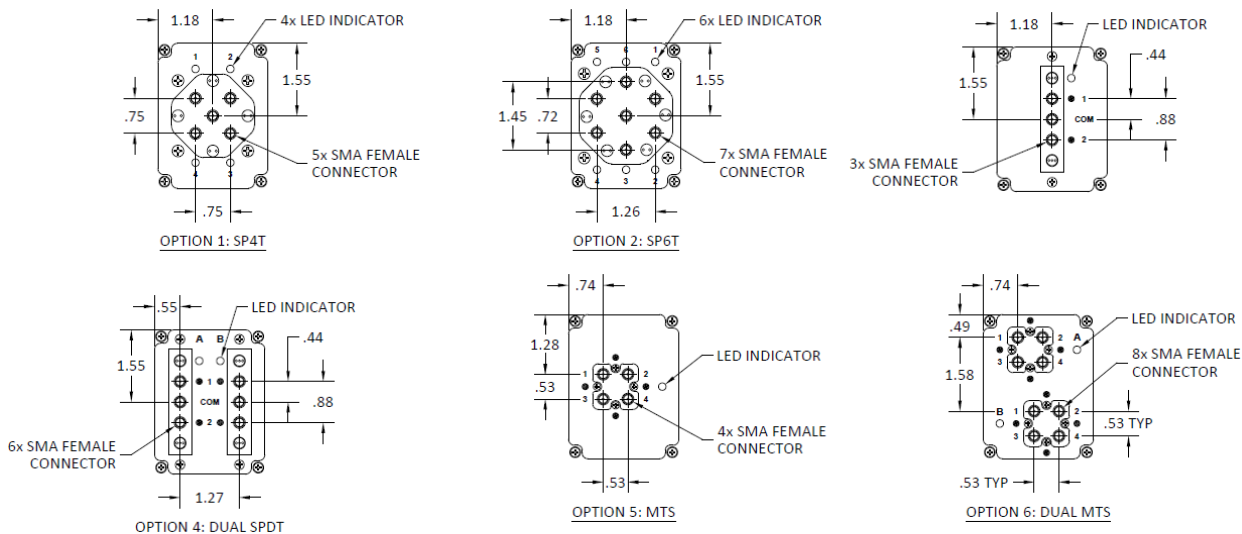

AC / DC Power Adapter

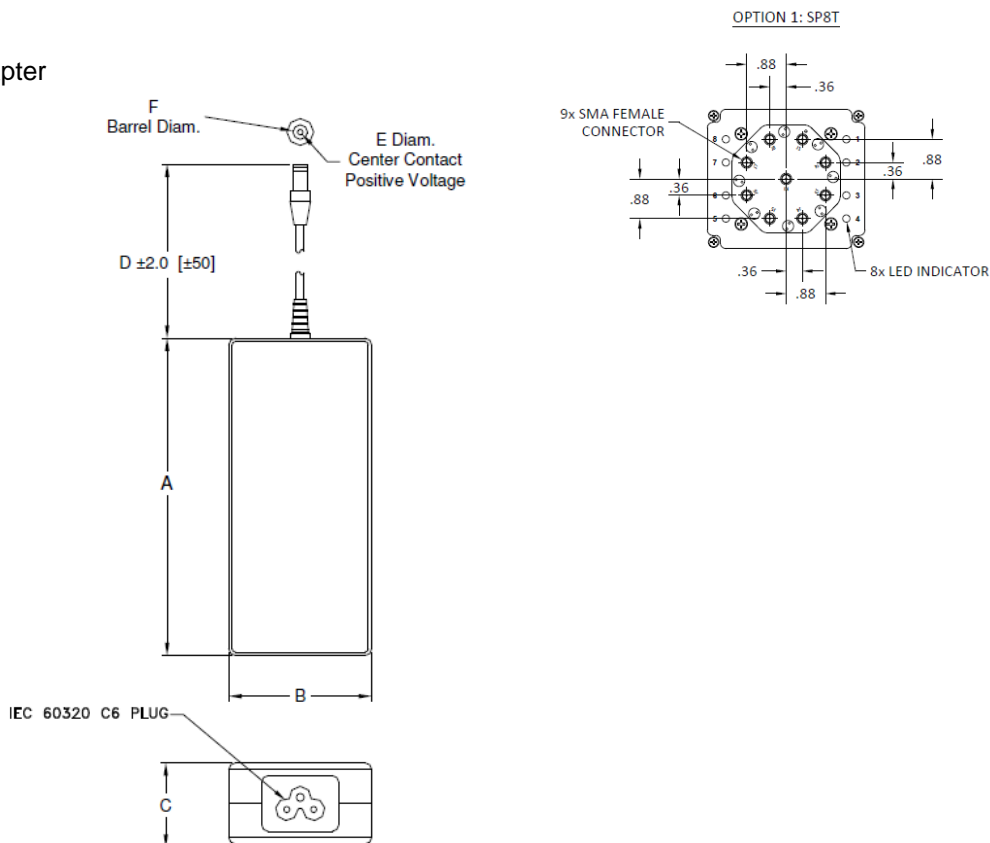

CASE#	A	B	C	D	E	F	WT. GRAMS
LR1590	4.72 (120)	2.13 (54)	1.26 (32)	72.8 (1850)	0.083 (2.1)	0.217 (5.5)	220