

Voltage Controlled Oscillator ROS-2488C-119+

50Ω 2488 MHz

The Big Deal:

- Low Phase Noise
- High Power Output
- Robust design and construction
- Small size .500" x .500" x .220"



CASE STYLE: CK1113

Product Overview:

The ROS-2488C-119+ is a Voltage Controlled Oscillator, designed to operate at 2488 MHz for military applications. The ROS-2488C-119+ is packaged in a metal case (size of .500" x .500" x .220") to shield against unwanted signals and noise.

Key Features

Feature	Advantages
Good Harmonic Suppression, -25dBc typ.	Provides clear signals suitable for systems requiring high spectral purity.
Low Phase Noise: -118dBc/Hz typ at 10kHz offset	Low phase noise improves system EVM (Error Vector Magnitude).
High Power Output, +8.5dBm typ.	Reduces amplification requirements and improves immunity to external noise sources.
Good Pulling, 1.5MHz typ.	Improves immunity against changes in output load.
Good Pushing, 0.05MHz/V typ.	Provides increased immunity against noisy DC lines and improves output frequency stability vs. variations in supply voltage.
Robust design and construction	Each internal component of the ROS-2488C-119+ is bonded to the substrate, providing better immunity to microphonics, reduced phase hit, and decreased tombstoning risk during subsequent reflow operations.
Small size, .500" x .500" x .220"	The small size enables the ROS-2488C-119+ to be used in compact designs.

Linear Tuning 2488 MHz

Features

- low phase noise, -118 dBc/Hz typ. @ 10kHz offset
- low pulling, 1.5 MHz typ.
- low pushing, 0.05 MHz/V typ.
- aqueous washable

Applications

- wireless communications
- military



CASE STYLE: CK1113

+RoHS Compliant

The +Suffix identifies RoHS Compliance. See our web site for RoHS Compliance methodologies and qualifications

Electrical Specifications

MODEL NO.	FREQ. (MHz)		POWER OUTPUT (dBm)	PHASE NOISE dBc/Hz SSB at offset frequencies, kHz				TUNING					NON HARMONIC SPURIOUS (dBc)	HARMONICS (dBc)		PULLING pk-pk @12 dB (MHz)	PUSHING (MHz/V)	DC OPERATING POWER	
	Min.	Max.		Typ.	1	10	100	1000	VOLTAGE RANGE (V)	SENSITIVITY (MHz/V)	PORT CAP (pF)	3 dB MODULATION BANDWIDTH (MHz)		Typ.	Typ.			Typ.	Typ.
ROS-2488C-119+	2488		+8.5	-92	-118	-140	-160	0.5	4.5	4.4	35	50	-90	-25	-15	1.5	0.05	5	33

Pin Connections

RF OUT	10
VCC	14
V-TUNE	2
GROUND	1,3,4,5,6,7,8,9,11,12,13,15,16

Maximum Ratings

Operating Temperature	-40°C to 85°C
Storage Temperature	-55°C to 100°C
Absolute Max. Supply Voltage (Vcc)	6.5V
Absolute Max. Tuning Voltage (Vtune)	7V
All specifications	50 ohm system

Permanent damage may occur if any of these limits are exceeded.

Tape & Reel: F37

7" Reels with 10, 20, 50, 100 devices
13" Reels with 200, 500 devices

Environmental Ratings: ENV65T2

Outline Drawing

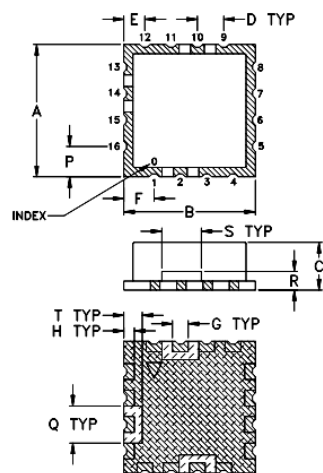

PCB Land Pattern

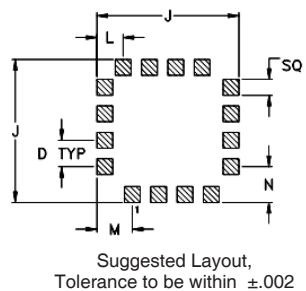

METALLIZATION
 SOLDER RESIST

Demo Board MCL P/N: TB-10 Suggested PCB Layout (PL-012)

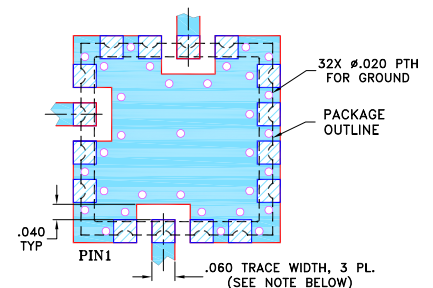

NOTES:

1. TRACE WIDTH IS SHOWN FOR FR4 WITH DIELECTRIC THICKNESS .030" ± .002"; COPPER: 1/2 OZ. EACH SIDE. FOR OTHER MATERIALS TRACE WIDTH MAY NEED TO BE MODIFIED.
 2. BOTTOM SIDE OF THE BOTTOM IS CONTINUOUS GROUND PLANE.
- DENOTES PCB COPPER LAYOUT WITH SMOBC (SOLDER MASK OVER BARE COPPER)
 DENOTES COPPER LAND PATTERN FREE OF SOLDER MASK

Outline Dimensions (inch/mm)

A	B	C	D	E	F	G	H	J	K	L	M	N	P	Q	R	S	T	wt.
.500	.500	.220	.100	.080	.115	.060	.040	.540	.060	.100	.135	.135	.115	.140	.070	.150	.070	grams
12.70	12.70	5.59	2.54	2.03	2.92	1.52	1.02	13.72	1.52	2.54	3.43	3.43	2.92	3.56	1.78	3.81	1.78	1.2

Performance Data & Curves*

ROS-2488C-119+

V TUNE	TUNE SENS (MHz/V)	FREQUENCY (MHz)			POWER OUTPUT (dBm)			I _{cc} (mA)	HARMONICS (dBc)			FREQ. PUSH (MHz/V)	FREQ. PULL (MHz)	PHASE NOISE (dBc/Hz) at offsets				FREQ OFFSET (kHz)	PHASE NOISE at 2488 MHz (dBc/Hz)
		-40°C	+25°C	+85°C	-40°C	+25°C	+85°C		F2	F3	F4			1kHz	10kHz	100kHz	1MHz		
0.00	6.16	2472.5	2476.1	2474.4	8.95	8.74	8.60	26.01	-26.0	-25.4	-41.8	0.09	1.61	-92.46	-118.3	-141.0	-160.7	1.0	-92.23
0.50	5.04	2475.2	2479.0	2477.4	9.01	8.80	8.66	26.04	-26.0	-26.3	-42.0	0.06	1.62	-91.96	-118.5	-140.4	-160.8	2.0	-100.74
0.75	4.76	2476.5	2480.3	2478.7	9.02	8.82	8.69	26.05	-26.0	-26.6	-42.8	0.05	1.61	-93.15	-118.8	-140.6	-159.5	3.5	-107.09
1.00	4.58	2477.6	2481.5	2480.0	9.04	8.83	8.72	26.06	-26.0	-26.7	-43.3	0.05	1.61	-93.03	-118.5	-140.0	-159.9	5.9	-112.97
1.25	4.45	2478.8	2482.6	2481.1	9.04	8.84	8.73	26.06	-26.1	-26.7	-44.0	0.05	1.60	-91.40	-118.2	-140.6	-160.5	8.5	-116.75
1.50	4.37	2479.9	2483.7	2482.3	9.05	8.84	8.74	26.07	-26.1	-26.7	-44.8	0.04	1.58	-92.03	-118.3	-140.8	-160.0	10.0	-118.54
1.75	4.33	2480.9	2484.8	2483.4	9.05	8.84	8.75	26.07	-26.1	-26.7	-45.3	0.04	1.57	-91.57	-118.0	-140.6	-159.5	20.7	-126.05
2.00	4.32	2482.0	2485.9	2484.4	9.05	8.84	8.76	26.08	-26.1	-26.6	-45.5	0.04	1.55	-91.97	-118.2	-140.8	-160.1	35.4	-131.11
2.25	4.32	2483.1	2487.0	2485.5	9.05	8.84	8.76	26.08	-26.2	-26.5	-46.0	0.04	1.52	-91.19	-118.2	-139.8	-160.0	60.5	-136.26
2.50	4.34	2484.2	2488.0	2486.6	9.05	8.84	8.76	26.08	-26.3	-26.4	-46.3	0.04	1.50	-91.67	-118.9	-141.0	-159.9	86.4	-139.37
2.75	4.36	2485.3	2489.1	2487.7	9.05	8.84	8.76	26.08	-26.4	-26.3	-46.1	0.04	1.47	-92.19	-118.6	-139.6	-160.2	100.0	-140.62
3.00	4.38	2486.4	2490.2	2488.8	9.04	8.84	8.76	26.09	-26.4	-26.4	-46.2	0.04	1.43	-91.40	-118.5	-140.4	-160.6	147.5	-144.32
3.25	4.38	2487.5	2491.3	2489.9	9.04	8.83	8.76	26.09	-26.5	-26.3	-46.2	0.04	1.39	-91.92	-118.6	-141.7	-161.5	176.4	-146.13
3.50	4.38	2488.6	2492.4	2491.0	9.03	8.83	8.76	26.10	-26.5	-26.4	-46.2	0.04	1.34	-91.08	-118.5	-140.6	-160.5	210.8	-147.83
3.75	4.36	2489.6	2493.5	2492.1	9.03	8.83	8.75	26.11	-26.6	-26.4	-46.8	0.05	1.29	-91.58	-118.4	-140.1	-160.9	301.2	-149.68
4.00	4.35	2490.7	2494.6	2493.2	9.02	8.82	8.75	26.12	-26.7	-26.3	-47.3	0.04	1.25	-91.45	-118.4	-140.4	-160.7	360.0	-152.21
4.25	4.33	2491.8	2495.7	2494.3	9.02	8.82	8.75	26.13	-26.7	-26.3	-48.0	0.04	1.20	-92.64	-117.8	-141.1	-160.6	505.3	-154.27
4.50	4.30	2492.9	2496.8	2495.4	9.01	8.81	8.74	26.13	-26.9	-26.4	-48.7	0.04	1.14	-93.25	-118.4	-139.6	-160.5	604.0	-155.68
4.75	4.28	2494.0	2497.8	2496.4	9.00	8.81	8.74	26.13	-26.9	-26.5	-49.1	0.04	1.09	-92.57	-118.7	-139.9	-161.2	995.5	-160.86
5.00	4.27	2495.0	2498.9	2497.5	9.00	8.81	8.73	26.14	-27.0	-26.6	-49.0	0.04	1.03	-92.90	-118.5	-140.2	-158.8	1000.0	-161.03

*at 25°C unless mentioned otherwise

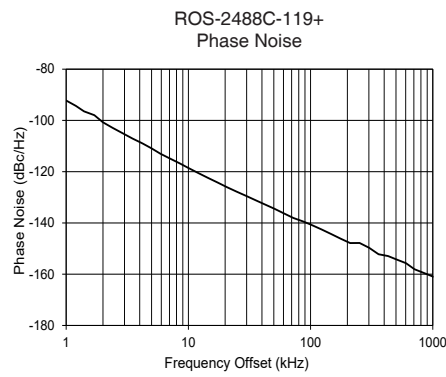
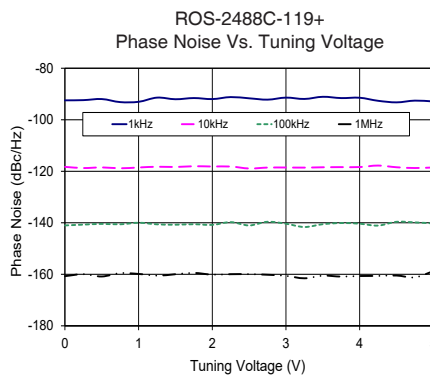
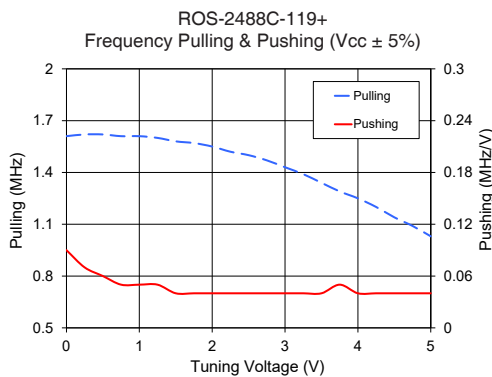
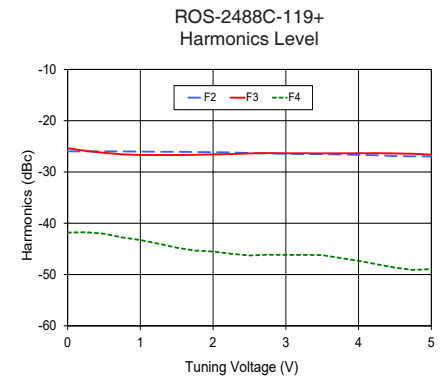
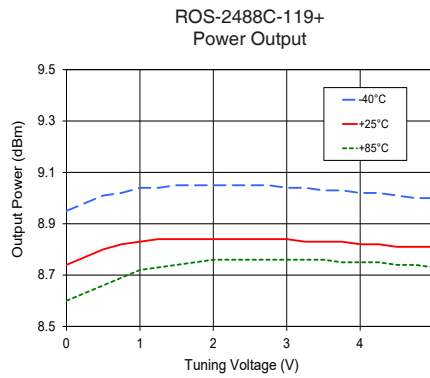
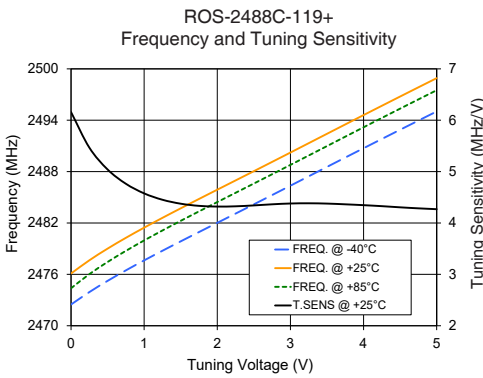

Additional Notes

- Performance and quality attributes and conditions not expressly stated in this specification document are intended to be excluded and do not form a part of this specification document.
- Electrical specifications and performance data contained in this specification document are based on Mini-Circuit's applicable established test performance criteria and measurement instructions.
- The parts covered by this specification document are subject to Mini-Circuits standard limited warranty and terms and conditions (collectively, "Standard Terms"); Purchasers of this part are entitled to the rights and benefits contained therein. For a full statement of the Standard Terms and the exclusive rights and remedies thereunder, please visit Mini-Circuits' website at www.minicircuits.com/MCLStore/terms.jsp