

USB / RS232 / SPI

Programmable Attenuator

RUDAT-13G-60

50Ω 0 – 60 dB, 0.5 dB step 10 to 13000 MHz

The Big Deal

- High Frequency, 13 GHz
- Wide attenuation range, 60 dB
- Fine attenuation resolution, 0.5 dB
- Compact size, 2.0 x 3.0 x 0.6"
- **USB, RS232 and SPI** control

Applications

- Automated Test Equipment (ATE)
- Transmission Loss / Fading Simulators
- Handover system evaluation
- Receiver sensitivity testing (eg: GPS)
- C-Band / X-Band radar testing

Product Overview

Mini-Circuits' RUDAT-13G-60 is a general purpose, single channel programmable attenuator suitable for a wide range of signal level control applications from 10 MHz to 13 GHz. The Attenuator provides 0 to 60 dB attenuation in 0.5 dB steps. Its unique design maintains linear attenuation change per dB, even at the highest attenuation settings.

The attenuator is housed in a compact and rugged package with SMA female connectors on the bi-directional input and output RF ports, a standard 9 pin D-Sub and a USB type Mini-B power and control ports.

The attenuator can be controlled via USB, RS232 or SPI (via D-Sub connector). Full software support is provided and can be downloaded from our website any time at <http://www.minicircuits.com/softwaredownload/patt.html>. The package includes our user-friendly GUI application for Windows® and a full API with programming instructions for Windows® and Linux® environments (both 32-bit and 64-bit systems).

Key Features

Feature	Advantages
USB control	The RUDAT-13G-60 can be controlled from any Windows® or Linux® computer with a USB connection. The device draws all power requirements through the USB port.
RS232 and SPI control	The user may also control the RUDAT-13G-60 via RS232 or SPI connection, allowing serial synchronous or a-synchronous communication with the device.
Programmable attenuation sweep and Hop sequences	The RUDAT-13G-60 can be programmed with a timed sequence of attenuation settings, to run without any additional external control
60 dB attenuation range.	The RUDAT-13G-60 provides high-accuracy attenuation up to 60 dB in 0.5 dB steps, allowing the user precise level control over a broad attenuation range.
High linearity	Typical input IP3 of +41 dBm up to 13000 MHz

Trademarks: Windows is a registered trademark of Microsoft Corporation in the United States and other countries. Linux is a registered trademark of Linus Torvalds. Mac is a registered trademark of Apple Corporation. Pentium is a registered trademark of Intel Corporation. Neither Mini-Circuits nor the Mini-Circuits RCDAT-series attenuators are affiliated with or endorsed by the owners of the above referenced trademarks.

Mini-Circuits and the Mini-Circuits logo are registered trademarks of Scientific Components Corporation.



Software Package

Case Style: QF2252

Included Accessories

Model No.	Description	Qty.
MUSB-CBL-3+	2.6 ft. USB cable	1

RoHS Compliant

See our web site for RoHS Compliance methodologies and qualifications

Electrical Specifications ¹ at 0°C to 50°C

Parameter	Frequency range	Conditions	Min.	Typ.	Max.	Units
Attenuation range	10 - 13000 MHz	0.5 dB step	0	-	60	dB
Attenuation accuracy ²	10 - 500 MHz	@ 0.5-14 dB	-	±0.60	±(5% of nominal value+0.9)	dB
		@ 14.5-60 dB	-	±0.65	±(1% of nominal value+1.45)	
	500 - 5000 MHz	@ 0.5-14 dB	-	±0.35	±(5% of nominal value+0.9)	
		@ 14.5-60 dB	-	±0.60	±(2% of nominal value+1.3)	
	5000 - 11000 MHz	@ 0.5-14 dB	-	±0.35	±(5% of nominal value+1)	
		@ 14.5-60 dB	-	±0.60	±(2.5% of nominal value+1.35)	
11000 - 13000 MHz	@ 0.5-14 dB	-	±0.60	±(4.5% of nominal value+1.1)		
	@ 14.5-60 dB	-	±0.70	±(2.5% of nominal value+1.35)		
Insertion Loss	10 - 500 MHz	@ 0 dB	-	4.8	6.5	dB
	500 - 5000 MHz		-	6.0	9.5	
	5000 - 11000 MHz		-	7.8	12.0	
	11000 - 13000 MHz		-	10.4	14.0	
Input operating power ³ (RF In and RF Out ports)	10 - 400 MHz	@ 0 - 60 dB	-	-	Note 4	dBm
	400 - 13000 MHz		-	-	+23	
Isolation In-Out	10 - 13000 MHz	Note 5	-	70	-	dB
IP3 Input ⁶	100 - 13000 MHz	@ 0 dB setting (P _{IN} =+5 dBm)	-	+41	-	dBm
VSWR	10 - 500 MHz	@ 0 - 3.5 dB	-	1.80	-	:1
		@ 4 - 45 dB	-	1.40	1.90	
		@ 45.5 - 60 dB	-	1.15	1.70	
	500 - 5000 MHz	@ 0 - 3.5 dB	-	1.45	-	
		@ 4 - 45 dB	-	1.30	1.80	
		@ 45.5 - 60 dB	-	1.15	1.65	
	5000 - 11000 MHz	@ 0 - 3.5 dB	-	1.45	-	
		@ 4 - 60 dB	-	1.35	2.00	
11000 - 13000 MHz	@ 0 - 3.5 dB	-	1.45	-		
	@ 4 - 60 dB	-	1.45	2.00		
Min Dwell Time ⁷	10 - 13000 MHz	High speed mode	-	600	-	µsec
Attenuation Transition Time ⁸	10 - 13000 MHz	-	-	900	-	nsec
Supply Voltage (via USB or D-Sub)	-	-	4.75	5	5.25	V
DC current draw (via USB or D-Sub)	-	@ 0 dB	-	150	190	mA
		@ 60 dB	-	90	120	
RS232 logic levels	Meets RS232 standard at all voltages with RS232 communications set to 9600 bps; 8 bit word; no parity; stop bit = '1'.					

¹ Attenuator RF ports are interchangeable, and support simultaneous, bidirectional signal transmission, however the specifications are guaranteed for the RF in and RF out as noted on the label. There may be minor changes in performance when injecting signals to the RF Out port.

² Max accuracy defined as ±[absolute error+% of attenuation setting] for example when setting the attenuator to 50 dB attenuation the maximum error at 12000 MHz will be: ±(0.025x50+1.35)= ±(1.25+1.35)= ± 2.6 dB

³ Total operating input power from both RF In and RF Out ports. Compression level not noted as it exceeds max safe operating power level.

⁴ Derate linearly from +23 dBm at 400 MHz to +10 dBm at 10 MHz.

⁵ Isolation is defined as max attenuation plus insertion loss; this is the path loss through the attenuator when initially powered up. After a brief delay (~0.5 sec typically) the attenuator will revert to a user defined "power-up" state (either max attenuation or a pre-set value).

⁶ Tested with 1 MHz span between signals. IP3 degrades below 100 MHz.

⁷ Minimum Dwell Time is the time the RUDAT will take to respond to a command to change attenuation states.

⁸ Attenuation Transition Time is specified as the time between starting to change the attenuation state and settling on the requested attenuation state..

Absolute Maximum Ratings

Operating Temperature	0°C to 50°C	
Storage Temperature	-20°C to 85°C	
Voltage input at D-Sub Pin#6-9	0V to +3.6V	
Voltage input at D-Sub Pin#3	-30V to +30V	
Voltage input at D-Sub Pin#2	0V to +4V	
Voltage input at D-Sub Pin#1	-1V to +6V	
V _{USB} Max.	6V	
DC voltage at RF port	16V	
Total RF power for RF In & RF Out	@ 10 - 400 MHz	Derates linearly from +25 @ 400 MHz to +13 @ 10 MHz
	@ 400 - 13000 MHz	+25 dBm

Permanent damage may occur if any of these limits are exceeded. Operating in the range between operating power limits and absolute maximum ratings for extended periods of time may result in reduced life and reliability.



Connections

RF IN	(SMA female)
RF OUT	(SMA female)
USB	(USB type Mini-B female)
RS232 & SPI*	(9 Pin D-Sub female)

The RS232 and SPI control connections share the same D-Sub 9-pin connector so special attention must be paid to the requirements of both standards when designing a control cable. Note in particular that RUDAT-13G models do not use the RS232 RTS (Ready to Send) function which is commonly implemented on pin 7 so it is important to disconnect this pin for RS232

control. Mini-Circuits provides a control cable (D-SUB9-MPT-3+) with D-sub 9-pin connector for mating to the RUDAT-13G and bare wire (“pigtail”) at the other end to allow connecting only the required connections to whichever connector type you are using.

Pin connections marked in red, in the pin connection table, should not be connected to allow proper device operation.

*9 Pin D-Sub Pin Connections

PIN Number	RS232 Function	SPI Function
1	Optional +5 V _{DC} ⁹	Optional +5 V _{DC} ⁹
2	RS232 Transmit	Do not connect
3	RS232 Receive	Do not connect
4	Do not connect	Do not connect
5	GND	GND
6	Do not connect	Do not connect
7	Do not connect	SPI LE
8	Do not connect	SPI Clock
9	Do not connect	SPI Data In

⁹ Pin#1 can be used as supply voltage (+) pin instead of USB connection. When USB power is connected, Pin#1 may be connected to GND or supply voltage (+) or remain disconnected.

Block Diagram

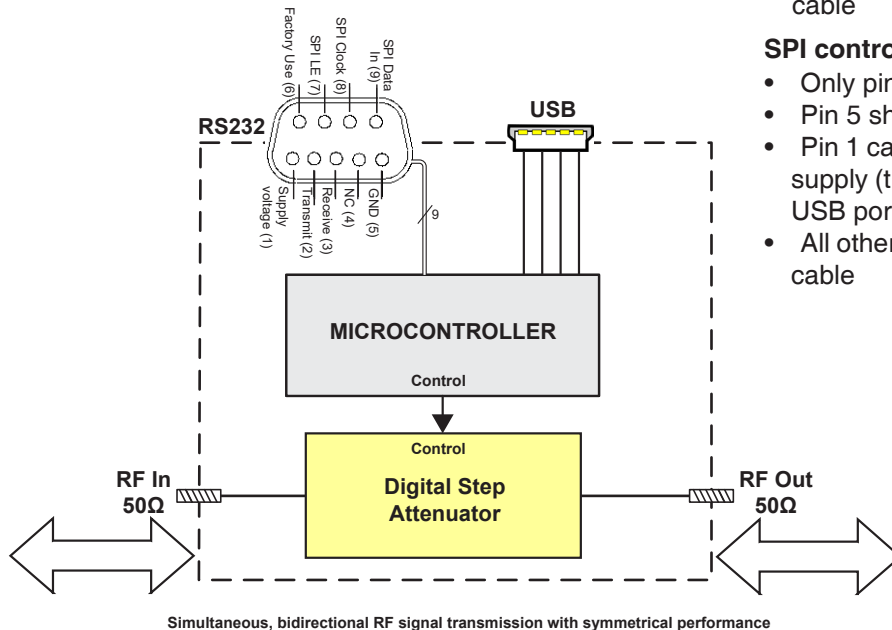

RS232 control pins

- Only pins 2 and 3 should be used for control
- Pin 5 should be grounded
- Pin 1 can optionally be used to provide the 5VDC supply (this could alternatively be provided via the USB port)
- All other pins must be disconnected in the control cable

SPI control pins

- Only pins 7, 8 and 9 should be used for control
- Pin 5 should be grounded
- Pin 1 can optionally be used to provide the 5VDC supply (this could alternatively be provided via the USB port)
- All other pins must be disconnected in the control cable

SPI communication parameters

Parameter	Conditions		Min.	Typ.	Max.	Units
Voltage levels	Logic High Voltage	Input	2.1	-	3.3	V
	Logic Low Voltage	Input	0	-	0.8	
Control Current	Per pin		-	-	1	mA
Clock Frequency	-		-	-	10	MHz

The SPI control used a 8-bit serial in, parallel-out shift register buffered by a transparent latch with Data, Clock, and Latch Enable (LE) voltages compatible with LVTTTL. The Data and Clock inputs allow data to be serially entered into the shift register, a process that is independent of the state of the LE input. The Value entered should be desired attenuation x 2, so for example to set attenuation level of 45.5 dB you will enter 91 decimal which is 0101 1011 in Binary.

The LE input controls the latch. When LE is HIGH, the latch is transparent and the contents of the serial shift register control the attenuator. When LE is brought LOW, data in the shift register is latched.

The shift register should be loaded while LE is held LOW to prevent the attenuation state from changing as data is entered. The LE input should then be toggled HIGH and brought LOW again, latching the new data. The timing for this operation is defined by the SPI Timing Diagram and SPI Interface AC Characteristics below.

SPI timing diagram

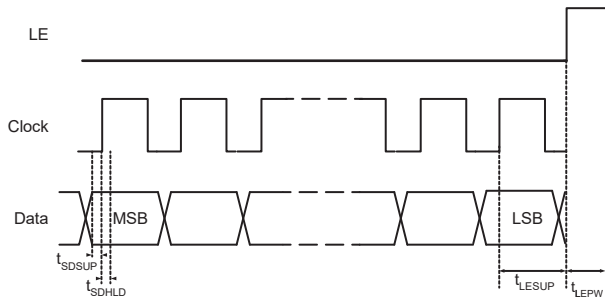

SPI Interface AC Characteristics				
Symbol	Parameter	Min.	Max.	Units
f_{clk}	Serial data clock frequency		20	MHz
t_{clkH}	Serial clock HIGH time	5		ns
t_{clkL}	Serial clock LOW time	5		ns
t_{LESUP}	LE set-up time after last clock falling edge	30		ns
t_{LEPW}	LE minimum pulse width	20		ns
t_{SDSUP}	Serial data set-up time before clock rising edge	5		ns
t_{SDHLD}	Serial data hold time after clock falling edge	5		ns

RUDAT response to communication interrupt

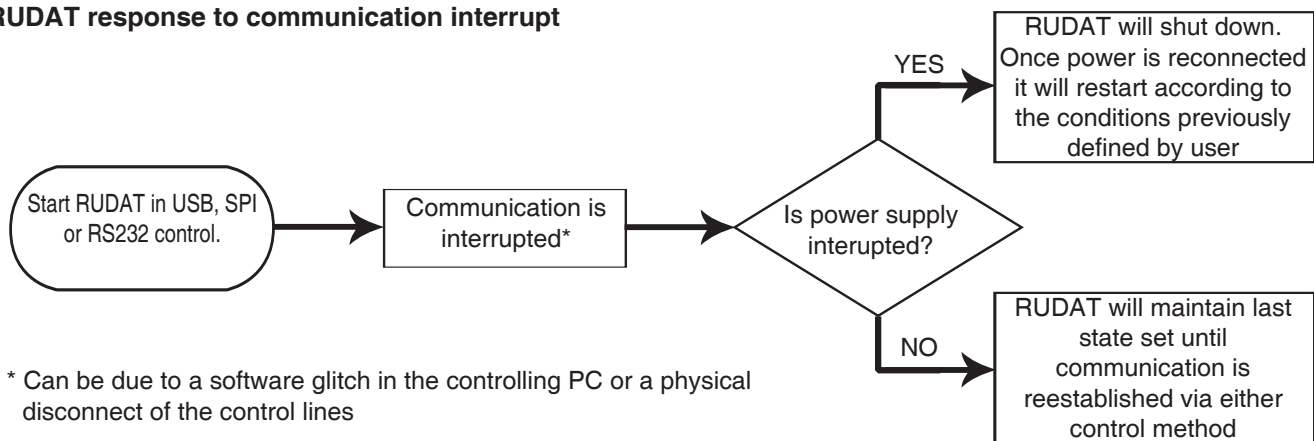

* Can be due to a software glitch in the controlling PC or a physical disconnect of the control lines

Outline Drawing (QF2252)

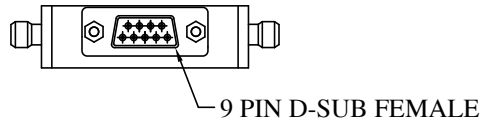

TOP VIEW

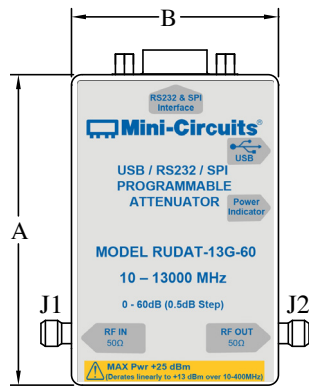

BOTTOM VIEW

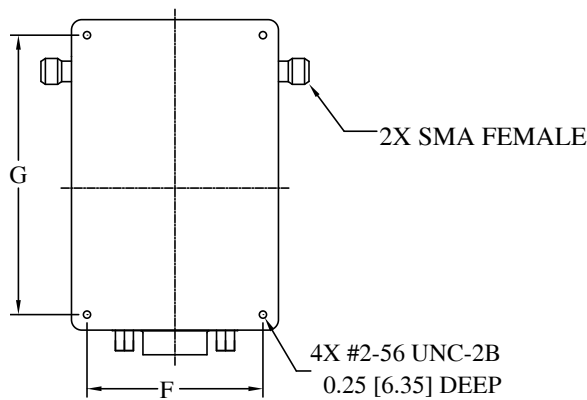

BRACKET OPTION

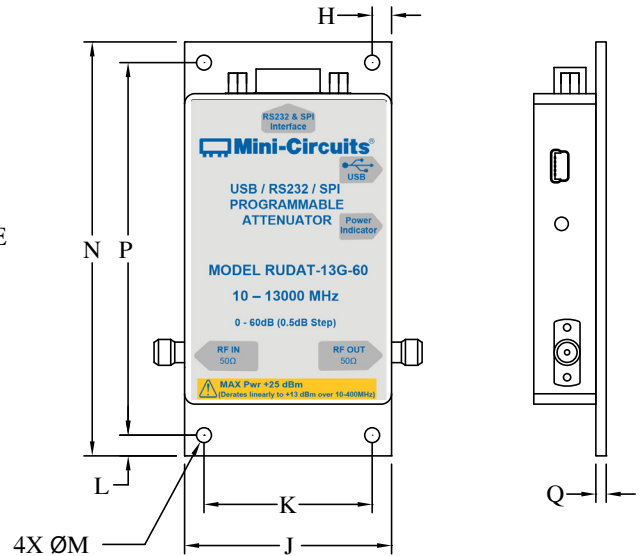

Instruction for mounting bracket:

1. Tool required: Phillips head screwdriver
2. Mount the bracket over threaded holes on the bottom side with the fasteners provided with the bracket.

Outline Dimensions (inch mm)

A	B	C	D	E	F	G	H	J	K	L	M	N	P	Q	WT. GRAMS
3.00	2.00	0.60	0.28	0.50	1.700	2.700	0.188	2.00	1.625	0.200	0.144	4.00	3.600	0.100	130
76.2	50.8	15.2	7.1	12.7	43.18	68.58	4.76	50.8	41.28	5.08	3.66	101.6	91.44	2.54	

Typical Performance Curves

Attenuation Accuracy @ +25°C vs. Frequency over Attenuation settings

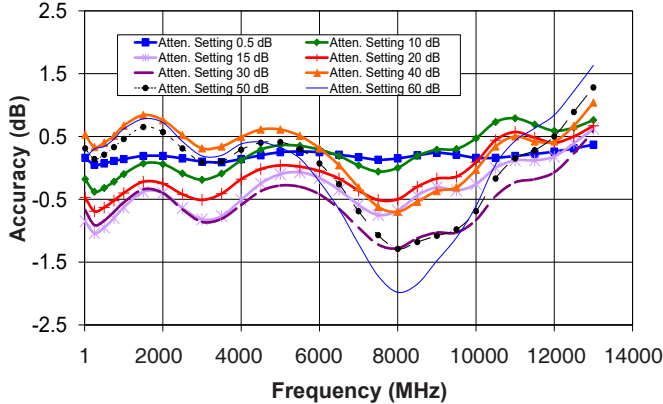

Attenuation relative to Insertion Loss @ +25°C vs. Frequency over Attenuation settings

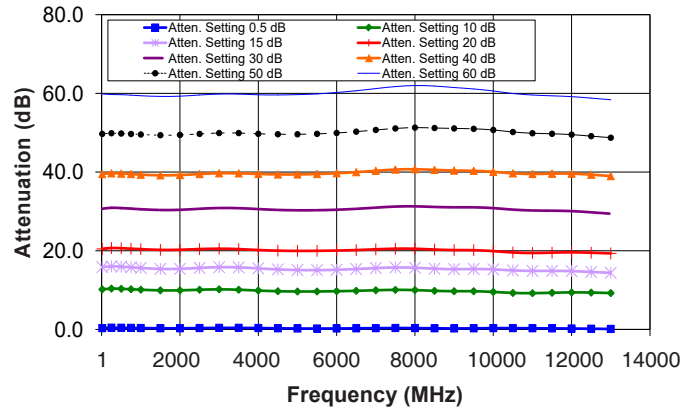

Attenuation Accuracy @ 0°C vs. Frequency over Attenuation settings

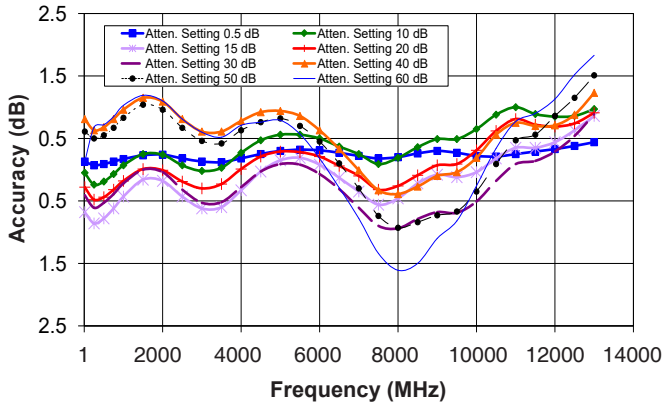

Attenuation relative to Insertion Loss @ 0°C vs. Frequency over Attenuation settings

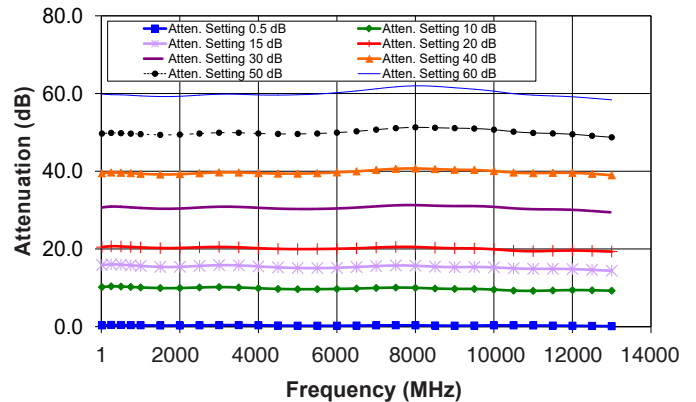

Attenuation Accuracy @ +50°C vs. Frequency over Attenuation settings

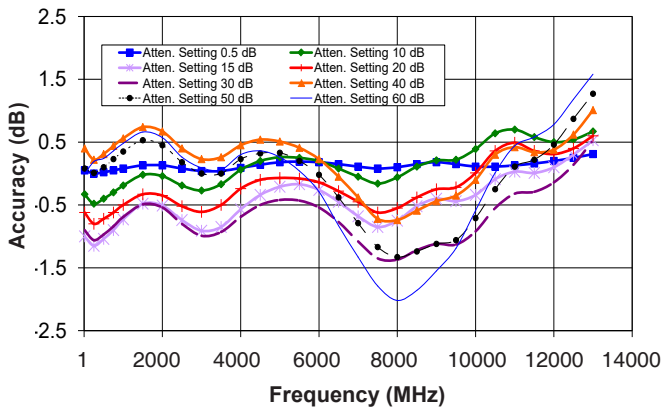

Attenuation relative to Insertion Loss @ +50°C vs. Frequency over Attenuation settings

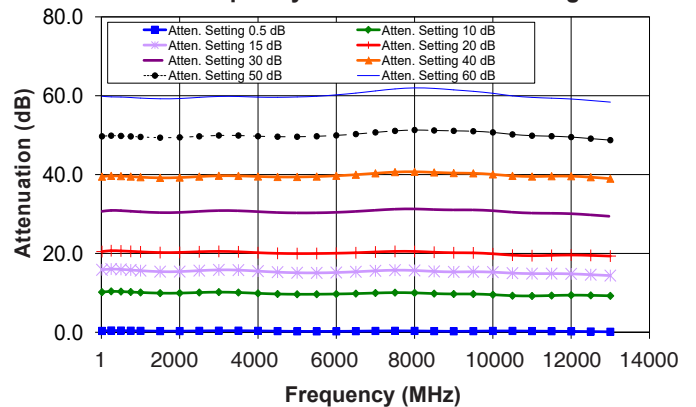

Typical Performance Curves (Continued)

Insertion Loss @ Input Power 0dBm vs. Frequency over Temperatures

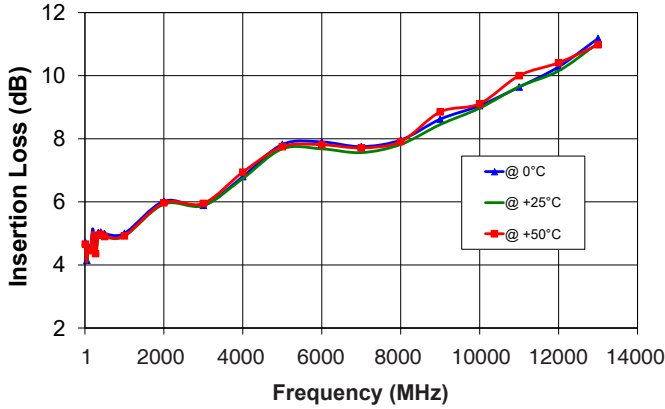

Insertion Loss @ Input Power +23 dBm vs. Frequency over Temperatures

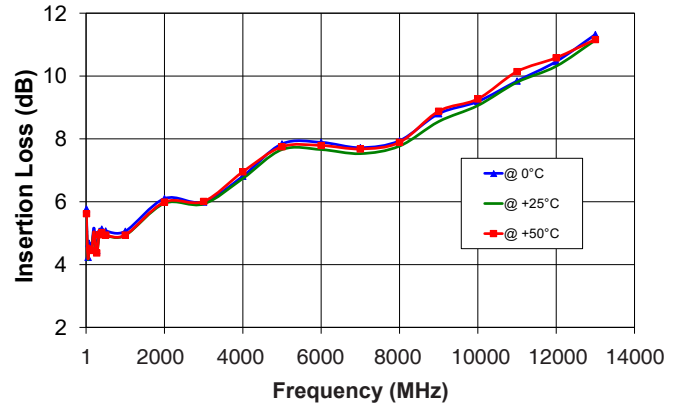

Output VSWR @ +25°C vs. Frequency over Attenuation settings

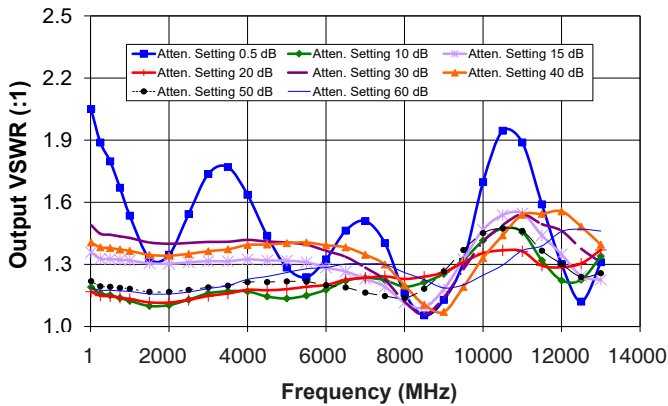

Input VSWR @ +25°C vs. Frequency over Attenuation settings

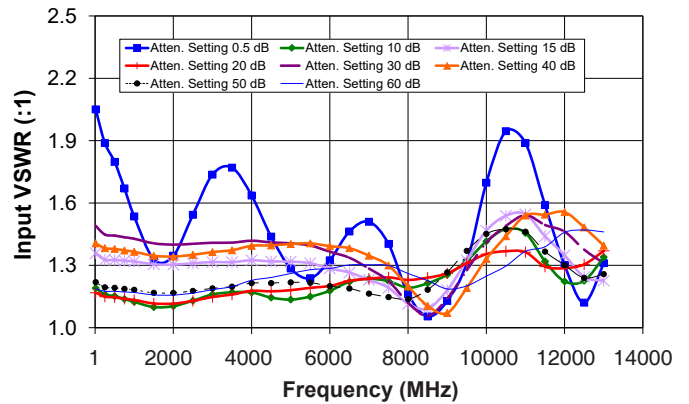

Input IP3 @ 0dB Attenuation vs. Frequency over Temperatures

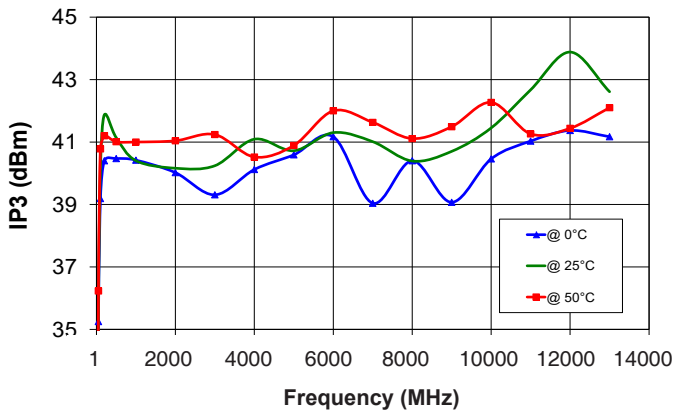

Typical Attenuation Accuracy @ 10-13000 MHz vs. Attenuation settings over Temperature

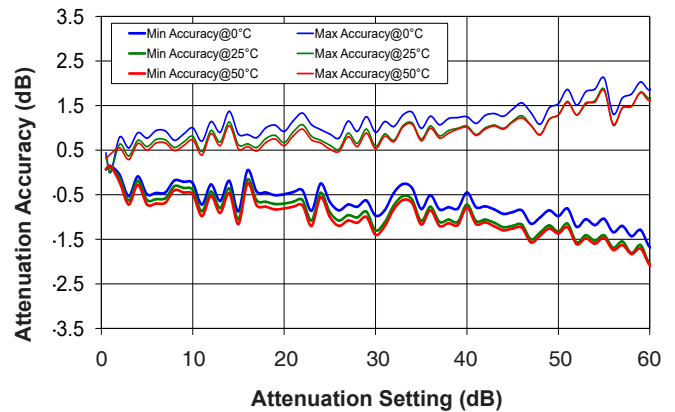

Software & Documentation Download:

- Mini-Circuits' full software and support package including user guide, Windows GUI, DLL files, programming manual and examples can be downloaded free of charge from <http://www.minicircuits.com/softwaredownload/patt.html>
- Please contact testsolutions@minicircuits.com for support

Minimum System Requirements

Parameter	Requirements	
Interface	USB HID or RS232 or SPI protocols	
System requirements	GUI:	Windows 32 & 64 bit systems from Windows 98 up to Windows 10
	USB API (ActiveX & .Net)	Windows 32 & 64 bit systems with ActiveX or .Net support from Windows 98 up to Windows 10
	USB direct programming support	Linux, Windows systems from Windows 98 up to Windows 10
	SPI	Any computer with a suitable I/O port
	RS232	Any computer with a serial port and RS232 support
Hardware	Pentium® II or higher, RAM 256 MB	

Graphical User Interface (GUI) for Windows

Key Features:

- Manual attenuation setting
- Sweep and Hop attenuation sequences directed from the PC, or entire sequence loaded into RUDAT.
- Attenuator address configuration and Firmware upgrade
- Attenuation at power up may be set to selected attenuation level or last attenuation state recorded.
- USB, RS232 or SPI control of RUDAT

Application Programming Interface (API)

Programming manual: https://www.minicircuits.com/softwaredownload/Prog_Manual-6-Programmable_Attenuator.pdf

Windows Support:

- API DLL files exposing the full switch functionality
 - ActiveX COM DLL file for creation of 32-bit programs
 - .Net library DLL file for creation of 32 / 64-bit programs
- Supported by most common programming environments (refer to application note [AN-49-001](#) for summary of tested environments)

Linux Support:

- Full attenuator control in a Linux environment is achieved by way of USB interrupt commands.

Recommended Accessories

An optional cable accessory for RS232 and SPI control which is available with RUDAT-13G-60, the D-SUB9-MPT-3+ 'pig tail' cable. D-SUB9-MPT-3+ is a shielded cable with a 'pig tail' (bare wires) end allowing customer to assemble their own cable with any connector they need. Cable length is 3 feet / 0.9 meters using 28 AWG wires.

Control Cable D-SUB9-MPT-3+

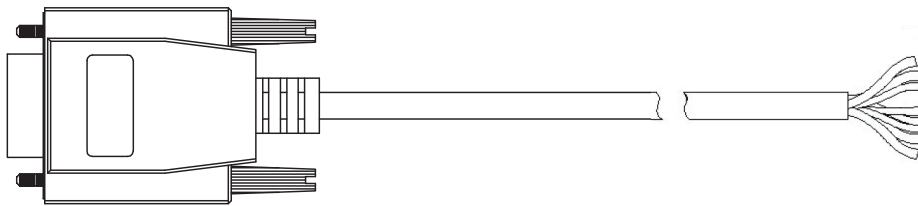

Pin Number	when used for RS232 control		when used for SPI control		Pigtail Wire Color
	Function	Description	Function	Description	
1	Vcc	Supply Voltage	Vcc	Supply Voltage	BLACK
2	Tx	RS232 transmit	N/A	Do not connect	BROWN
3	Rx	RS232 Recieve	N/A	Do not connect	RED
4	N/A	Do not connect	N/A	Do not connect	ORANGE
5	GND	Ground connection	GND	Ground connection	YELLOW
6	N/A	Do not connect	N/A	Do not connect	GREEN
7	N/A	Do not connect	LE	Latch Enable for SPI	BLUE
8	N/A	Do not connect	Clock	Clock for SPI	PURPLE
9	N/A	Do not connect	Data	Data in for SPI	WHITE

Ordering Information

Model	Description
RUDAT-13G-60	USB/RS232 Programmable Attenuator

Included Accessories	Part No.	Description
	MUSB-CBL-3+	2.6 ft (0.8 m) USB Cable: USB type A(Male) to USB type Mini-B(Male)

Optional Accessories	Description
USB-AC/DC-5 ^{10,11}	AC/DC 5V _{DC} Power Adapter with US, EU, IL, UK, AUS, and China power plugs
MUSB-CBL-3+ (spare)	2.6 ft (0.8 m) USB Cable: USB type A(Male) to USB type Mini-B(Male)
MUSB-CBL-7+	6.6 ft (2.0 m) USB Cable: USB type A(Male) to USB type Mini-B(Male)
D-SUB9-MPT-3+	3 ft RS232 Cable: 9 pin D-sub(Male) to Pig-Tail (Bare wires)
BKT-3901+	Bracket kit including 3.75" x 2.00" bracket, mounting screws and washers

¹⁰ Not used in USB control. USB-AC/DC-5 can be used to provide the 5V_{DC} power when control is via RS232 or SPI; units can also accept DC supply voltage at Pin#1 of the D-sub connector.

¹¹ Power plugs for other countries are also available, if you need a power plug for a country not listed please contact testsolutions@minicircuits.com

Additional Notes

- A. Performance and quality attributes and conditions not expressly stated in this specification document are intended to be excluded and do not form a part of this specification document.
- B. Electrical specifications and performance data contained in this specification document are based on Mini-Circuit's applicable established test performance criteria and measurement instructions.
- C. The parts covered by this specification document are subject to Mini-Circuits standard limited warranty and terms and conditions (collectively, "Standard Terms"); Purchasers of this part are entitled to the rights and benefits contained therein. For a full statement of the Standard Terms and the exclusive rights and remedies thereunder, please visit Mini-Circuits' website at www.minicircuits.com/MCLStore/terms.jsp