

Surface Mount 
RF Transformer

SCTX4-52HP-20W+

12.5/50Ω 30 to 512 MHz 20 Watt 1:4 Ratio

The Big Deal

- High power handling, 20W
- Low insertion loss, 0.30 dB typ.
- Small size, 0.5 x 0.5 x 0.2"



CASE STYLE: CK2335-1

Product Overview

Mini-Circuits' SCTX4-52HP-20W+ is a high-power, surface-mount transformer with a secondary/primary impedance ratio of 1:4, covering the 30 to 512 MHz band. The transformer is capable of handling RF input power up to 20W across entire bandwidth. It provides low insertion loss (0.3 dB) as well as good matching VSWR 1.10:1. Featuring core and wire construction mounted on PCB, the unit comes enclosed in a miniature, shielded package measuring just 0.50 x 0.50 x 0.20", ideal for dense circuit board layouts.

Key Features

Feature	Advantages
High RF power handling (20W)	Supports systems with high power requirements in small device size.
Low insertion loss, 0.3 dB	Provides excellent transmission of signal power from input to output.
Good Return Loss, 20 dB typ	Provide good in to output impedance matching.
Small footprint, 0.50 x 0.50 x 0.20"	Accommodates tight space requirements for dense PCB layouts.

Surface Mount  **RF Transformer**

SCTX4-52HP-20W+

12.5/50Ω 30 to 512 MHz 20 Watt 1:4 Ratio

Features

- high power input, 20 Watt max.
- low insertion loss, 0.3 dB typ.
- small size, 0.50 x 0.50 x 0.20
- excellent return loss, 23 dB typ.

Applications

- VHF/UHF Radios & Aircraft Communications
- PCS
- BALUN
- diode matching



Generic photo used for illustration purposes only

CASE STYLE: CK2335-1

+RoHS Compliant

The +Suffix identifies RoHS Compliance. See our web site for RoHS Compliance methodologies and qualifications

Available Tape and Reel at no extra cost

Reel Size	Devices/Reel
7"	10, 20, 50, 100
13"	200, 500

Electrical Specifications at 25°C

Parameter	Frequency (MHz)	Min.	Typ.	Max.	Unit
Impedance Ratio (secondary/primary)			4		
Frequency Range		30	—	512	MHz
Insertion Loss	30 - 100	—	0.3	0.5	dB
	30 - 512	—	0.5	0.9	
Return Loss* (Primary)	30 - 100	20	30	—	dB
	30 - 512	12	20	—	
Input Power	30 - 512	—	—	20	Watt

* For the frequency range from 450 to 512MHz, the Return loss may go up to the Min. spec.

Maximum Ratings

Parameter	Ratings
Operating Temperature	-40°C to 85°C case*
Storage Temperature	-55°C to 100°C

*Case temperature is defined as temperature on ground leads. Permanent damage may occur if any of these limits are exceeded.

Pad Connections

Function	Pad Number
PRIMARY (12.5 ohm)	4,5
SECONDARY (50 ohm)	8,9
GND	all others

Product Marking

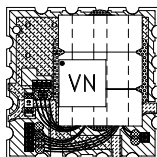

Configuration D

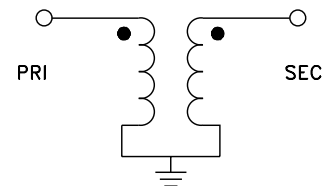

SCTX4-52HP-20W+

Outline Drawing

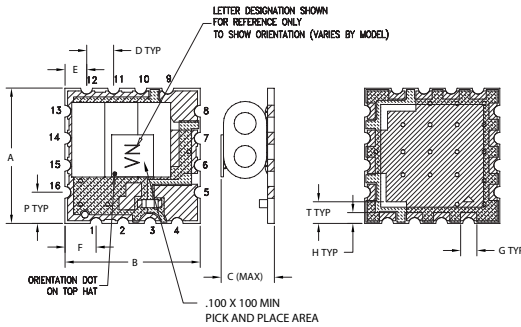

PCB Land Pattern

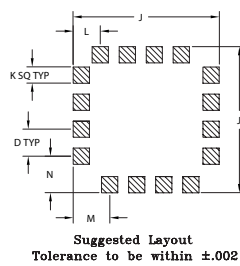

DENOTES METALLIZATION.
 DENOTES SOLDER MASK.

Outline Dimensions (inch)

A	B	C	D	E	F	G	H
.500	.500	.209	.100	.080	.115	.060	.040
12.70	12.70	5.31	2.54	2.03	2.92	1.52	1.02
J	K	L	M	N	P	T	wt.
.540	.060	.100	.135	.135	.115	.080	grams
13.72	1.52	2.54	3.43	3.43	2.92	2.03	1.0

Demo Board MCL P/N: TB-SCTX452HP20W Suggested PCB Layout (PL-698)

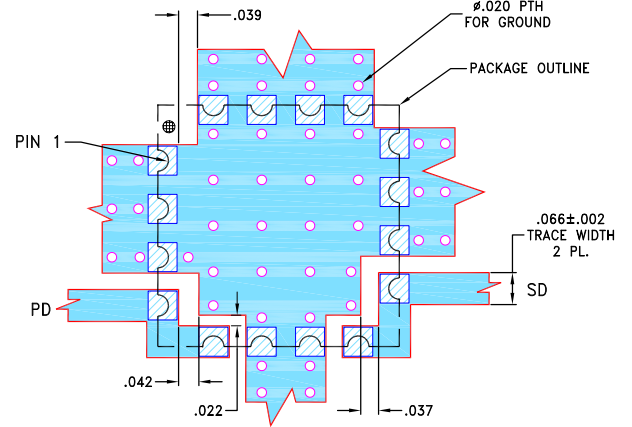

NOTES:

- TRACE WIDTH IS SHOWN FOR ROGERS R04350B, WITH DIELECTRIC THICKNESS .030"±.002". COPPER: 1/2 Oz. EACH SIDE. FOR OTHER MATERIALS TRACE WIDTH MAY NEED TO BE MODIFIED.
- BOTTOM SIDE OF THE PCB IS CONTINUOUS GROUND PLANE.

Typical Performance Data

FREQUENCY (MHz)	INSERTION LOSS (dB)	PRIMARY R. LOSS (dB)
30	0.18	36.03
60	0.19	48.98
104	0.23	38.98
188	0.23	29.44
274	0.34	24.71
340	0.39	22.22
360	0.40	21.50
404	0.45	20.09
468	0.52	18.23
512	0.58	16.91

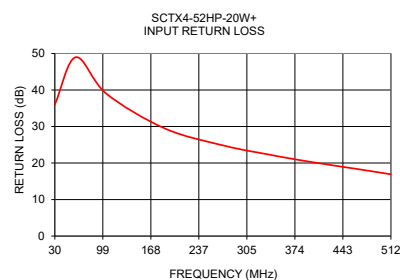
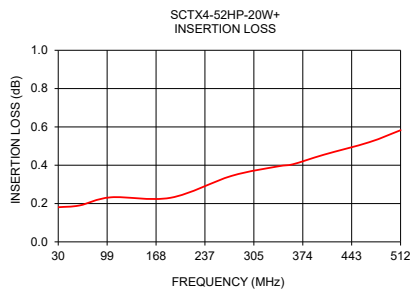

Additional Notes

- Performance and quality attributes and conditions not expressly stated in this specification document are intended to be excluded and do not form a part of this specification document.
- Electrical specifications and performance data contained in this specification document are based on Mini-Circuit's applicable established test performance criteria and measurement instructions.
- The parts covered by this specification document are subject to Mini-Circuits standard limited warranty and terms and conditions (collectively, "Standard Terms"); Purchasers of this part are entitled to the rights and benefits contained therein. For a full statement of the Standard Terms and the exclusive rights and remedies thereunder, please visit Mini-Circuits' website at www.minicircuits.com/MCLStore/terms.jsp

