



## USB & ETHERNET & DAISY-CHAIN

# Signal Generator

## SSG-5N9GD-RC

50Ω    5000 to 9000 MHz    -55 dBm to +23 dBm    SMA Female    Dual Channel

### THE BIG DEAL

- Two independently tunable channels
- Cost effective C-band / ISM signal generator
- High output power, +23 dBm
- Good harmonics & phase noise
- CW, pulsed, AM, FM & chirp outputs
- Daisy-chain for multi-module dynamic control
- Power over Ethernet (PoE) enabled

### APPLICATIONS

- Semiconductor high power burn-in & life testing
- Benchtop signal generator
- Automated production test systems
- C-band / ISM testing
- Quantum computing

### PRODUCT OVERVIEW

Mini-Circuits' SSG-5N9GD-RC is a dual-channel wide-band signal generator operating from 5000 to 9000 MHz. With up to +23 dBm typical output power, it is an ideal signal source for characterization of millimeter wave components and systems at high power. Configure CW / single-tone outputs, flexible pulse sequences, AM, FM and Chirp modulations, or automated frequency / power sweep & hop sequences.

SSG-5N9GD-RC has been developed in a compact package with powerful software control and automation to provide a cost effective C-band / ISM signal generator and LO source for any bench or production test application. This is a high quality, repeatable and reliable signal source with low phase noise and excellent harmonic rejection.

The generator can be controlled via USB or Ethernet (supporting SSH, HTTP & Telnet protocols). A USB cable with screw lock fastens the cable securely to the module. Full software support is provided, including our user-friendly GUI application for Windows, flexible API and programming instructions for Windows and Linux environments. The daisy-chain control interface with "dynamic addressing" simplifies control integration and allows multiple units to be combined into a multi-channel signal source with control through a single software interface.

### KEY FEATURES

Feature	Advantages
High quality signal source	Outstanding combination of fine frequency and power resolution, low phase noise, excellent harmonic rejection, and low spurious signals in a compact package; with two independently tunable channels suited for a wide range of applications .
Dual Channel	Operate as 2 independent, exceptional-value signal sources, or as a dual-channel source with synchronized, phase adjustable outputs.
Flexible pulse, AM, FM and Chirp modulation	Configure various analog modulations according to your needs.
Sweep & Hop sequences	Configure custom CW output frequency and power sequences to run unaided for high speed, automated test applications.
Dynamic daisy-chain control	Simplify control software and interconnections and develop low-cost, multi-channel signal generator systems by daisy-chaining multiple units with control through a single interface.

#### Trademarks:

Windows is a registered trademark of Microsoft Corporation in the United States and other countries ; Linux is a registered trademark of Linus Torvalds ; Intel is a registered trademark of Intel Corporation. Neither Mini-Circuits nor the Mini-Circuits products are affiliated with or endorsed by the owners of the referenced trademarks. Mini-Circuits and the Mini-Circuits logo are registered trademarks of Scientific Components Corporation.



Generic photo used for illustration purposes only



### ELECTRICAL SPECIFICATIONS <sup>1</sup>, +25°C

Parameter	Condition (MHz)		Min.	Typ.	Max.	Unit
Output Frequency	-		5000	-	9000	MHz
Frequency Resolution <sup>2</sup>	5000 - 9000		-	1	-	Hz
Frequency Accuracy	Using internal reference		-	±1	-	ppm
Return Loss	5000 - 9000		-	-10	-	dB
Output Power Max	5000 - 9000		+20	+23	-	dBm
Output Power Min	5000 - 9000		-	-55	-50	dBm
Power Resolution (nominal)	5000 - 9000		-	0.1	-	dB
Output Power Accuracy	-50 to +20 dBm	5000 - 9000	-	±0.5	±1.0	dB
RF Output Leakage	RF Off	5000 - 9000	-	-80	-	dBm
Harmonics <sup>3</sup>	-50 to +20 dBm	5000 - 7000	-	-15	-	dBc
		7000 - 9000	-	-30	-	
Non-Harmonic Spurious	0 dBm to Max Power	Offsets 100 KHz to 150 MHz	-	-70	-	dBc
Boundary Spurs		5000 - 9000	-	-40	-	
Isolation (between channels)	-50 to +20 dBm	5000 - 9000	-	-60	-	dB
Settling Time <sup>4,5</sup>	Hop mode <sup>6</sup>	5000 - 9000	-	0.12	0.20	ms
	Frequency sweep	5000 - 9000	-	0.15	0.22	
	Power transition (at set frequency)		-	0.015	-	
	PC (external) control		-	2	-	
Dwell Time (nominal) <sup>5,7</sup>	-	-	0.01	-	10,000	ms
Phase Offset Range	-	-	0	-	359	deg
Phase Offset Resolution	-	-	-	1	-	

- Specifications are after 15 minutes warm-up time.
- Frequency Resolution is tested with 10 MHz external reference.
- It is recommended using Mini-Circuits' [VLF-8400+](#) filter together with the SSG-5N9G-RC to improve SSG harmonics at lower frequencies.
- Settling Time - transition time between 2 output states. During the transition, RF output is turned off to avoid transient outputs.
- Generator response time is Dwell Time + Settling Time.
- For hop sequences pre-loaded into internal memory (high-speed mode).
- Dwell Time - duration of each signal point in a Sweep or Hop sequence set by user. Default is minimum dwell time.

### PHASE NOISE (SSB), +25°C

Frequency Offset (kHz)	Carrier Frequency (MHz)					
	5000		7000		9000	
	Typ.	Max	Typ.	Max	Typ.	Max
1	-98.5	-96.0	-95.5	-93.0	-93.5	-91.0
10	-109.5	-107.0	-106.5	-104.5	-104.5	-102.0
100	-117.0	-115.0	-114.5	-112.0	-112.0	-109.5
1,000	-125.0	-122.5	-119.0	-115.5	-120.0	-117.5
10,000	-145.5	-142.5	-145.0	-142.0	-145.0	-142.0
Noise Floor	-150.0	-146.0	-150.0	-146.0	-150.0	-146.0



### REFERENCE, TRIGGER & DC POWER, +25°C

Parameter	Condition		Min.	Typ.	Max.	Unit
Aging	Using internal reference		-	2	-	ppm/yr
Reference In	Frequency	-	-	10	-	MHz
	Power	-	-3.5	-	+12.5	dBm
	Phase noise	10 kHz Offset	-	-135	-	dBc/Hz
Reference Out	Frequency	-	-	10	-	MHz
	Frequency accuracy	Using internal reference	-	±1	-	ppm
	Power	-	-	+10	-	dBm
	Phase noise	10 kHz Offset	-	-140	-	dBc/Hz
Trigger Out <sup>8</sup>	Low		0	-	0.4	V
	High		3.0	-	5.0	
	Pulse width		-	100	-	µs
Trigger In	Low		0	-	0.4	V
	High		3.0	-	5.0	
	Pulse width		-	1	-	µs
Supply Voltage (V <sub>DC</sub> )	DC Input port <sup>9</sup>		5.7	6.0	6.3	V <sub>DC</sub>
Supply Current (I <sub>DC</sub> )			-	2.2	2.8	A
Supply Current (I <sub>DC</sub> )	USB port <sup>9</sup>		-	20	-	mA
Supply Voltage (V <sub>DC</sub> )	LAN port <sup>9, 10</sup>		50	53	57	V <sub>DC</sub>
Supply Current (I <sub>DC</sub> )			-	300	450	mA

8. Trigger out voltage specified with impedance load of 10 kΩ minimum.

9. Power must be provided via the 2.1 mm DC Input or LAN port (using PoE systems) before connecting the unit to USB. The same is true in reverse, disconnect unit from USB before disconnecting power supply.

10. Compliant with IEEE 802.3at mode A and mode B.

### ABSOLUTE MAXIMUM RATINGS

Operating Temperature	0°C to 50°C
Storage Temperature	-20°C to 60°C
Power in @ Reference in	+15 dBm
Reverse Voltage (DC) @ Reference out	8 V <sub>DC</sub>
Reverse Voltage (DC) @ RF out	15 V <sub>DC</sub>
Reverse Power (RF) @ RF out	+24 dBm
Voltage input to trigger ports	-0.3V <sub>DC</sub> to +5.5V <sub>DC</sub>

Permanent damage may occur if any of these limits are exceeded. Operating in the range between operating power limits and absolute maximum ratings for extended periods of time may result in reduced life and reliability.



### CHIRP MODULATION, +25°C

FMCW chirp signals are repeating pulses of ascending frequency from a specified start to stop value. The SSG supports chirp signals with triangular or sawtooth waveform and external trigger input / output options for synchronisation.

Chirps must be configured within the frequency bands noted in the "Chirp Frequency Bands" table below (limited by the internal oscillators) and will have a linear response when kept within the noted sub-bandwidth limits.

The minimum chirp duration varies with frequency and bandwidth, but typical examples are summarised below. Even lower durations can be set in practice with some degradation of the waveform shape.

Parameter	Condition (Start/Stop MHz)		Min.	Typ.	Max.	Unit
Modulation Shape	Triangle or sawtooth wave					
Chirp Duration (nominal) <sup>10</sup>	5000	5050	-	40	655	µs
	6500	6550	-	20	655	
	8300	8400	-	50	655	
Trigger Input Options	Free running					
Trigger Output Profile	Trigger out toggles high and low once to indicate start of chirp					

10. Chirp Duration limits of example frequencies were tested at 0 dBm.

### CHIRP FREQUENCY BANDS <sup>11, 12</sup>

#	Frequency (MHz)		Sub-bandwidth (MHz)
	Start	End	
1	7500	9000	120
2	5000	7500	60

11. Chirp signal must be within a single frequency band.  
12. Going over the chirp sub-bandwidth will introduce signal noise (see example images).

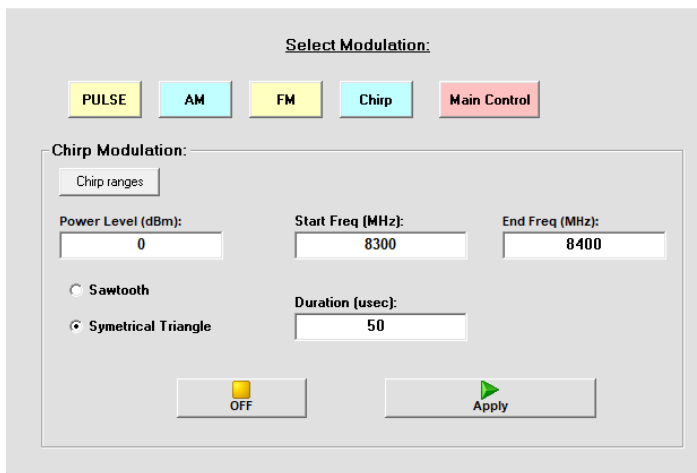



### CHIRP MODULATION, +25°C (CONTINUED)

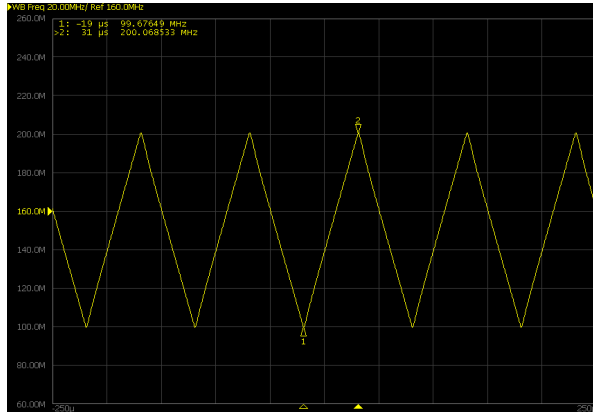

Triangle signal, 8300 - 8400 MHz, 50 μs, within sub-bandwidth

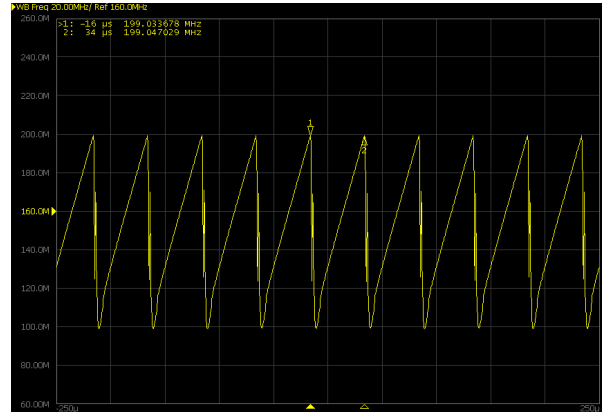

Sawtooth signal, 8300 - 8400 MHz, 50 μs, within sub-bandwidth

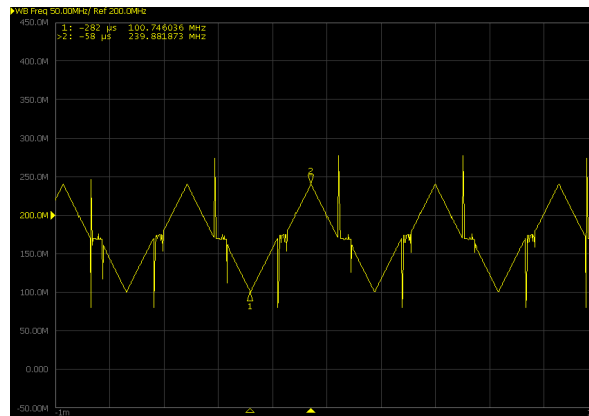

Triangle signal, 8300 - 8440 MHz, 200 μs, over sub-bandwidth

### PULSE MODULATION, +25°C

Parameter	Condition	Min.	Typ.	Max.	Unit
Pulse Width <sup>13, 14</sup>	Measured at 50% of pulse level	5	-	10e6	μs
Pulse Width Resolution	Nominal value	0.05	-	-	μs
Pulse Width Accuracy <sup>15</sup>	Measured at 50% of pulse level	-	±10	-	%
Rise / Fall Time <sup>16, 17</sup>	Measured between 10% and 90% of pulse level	-	180 / 150	-	ns
Pulse Power Ratio	PWR <sub>OUT</sub> = +20 dBm, FREQ <sub>OUT</sub> = 5000 MHz	-	70	-	dB
	PWR <sub>OUT</sub> = +20 dBm, FREQ <sub>OUT</sub> = 9000 MHz	-	70	-	

13. Pulse Width must be less than pulse period by at least 0.5 μs with Internal pulse modulation and by 2 μs in external pulse modulation.

14. Pulse Widths below 0.5 μs can be set, however performance is only guaranteed for the ranges noted in the table.

15. Pulse Width Accuracy is 10% of pulse width, or ±100 ns, whichever is greater.

16. Pulse Rise time will increase with pulse interval under 3 μs.

17. For signals at same power & frequency.



### REGULAR PULSE MODULATION, +25°C

Repetitive RF pulse sequences with fixed frequency and power, supporting internal or external modulation and input / output trigger options.

Parameter	Condition	Min.	Typ.	Max.	Unit
Pulse Period	Measured at 50% of pulse level	10	-	10e6	μs
Trigger Response Delay	Trigger edge to 50% of pulse level	Internal pulse modulation	1	-	μs
		External pulse modulation	2	-	
External pulse modulation input threshold	External pulse modulation	3	-	-	V
Trigger Input Options	Free running, triggered or external modulation source (continuous)				
Trigger Output Profile	-				

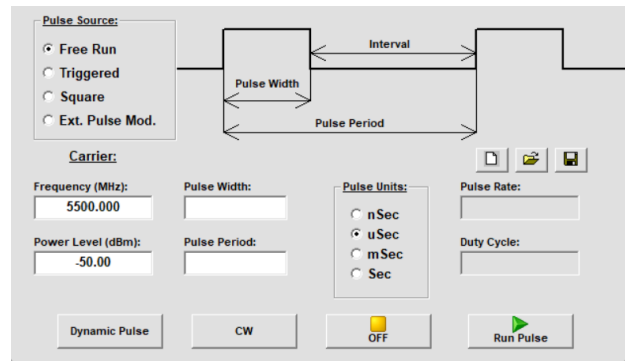
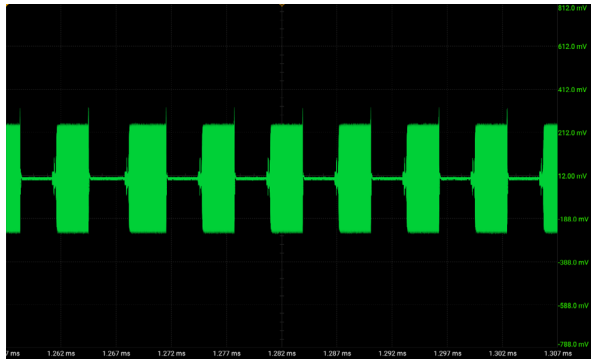

### DYNAMIC PULSE MODULATION, +25°C

Flexible RF pulse sequences with varying frequency, power, pulse width and pulse repetition interval (PRI).

Parameter	Condition	Min.	Typ.	Max.	Unit	
Pulse Interval	Measured at 50% of pulse level	Fixed freq. & Power	7	-	4e6	μs
		Varying freq. & Power	150	-	4e6	
Duty Cycle (in Free Run)	Pulse width divided by Pulse period	0.1	-	99.9	%	
Trigger Input Options	Free running or triggered (single or continuous)					
Trigger Output Profile	After each pulse or cycle					

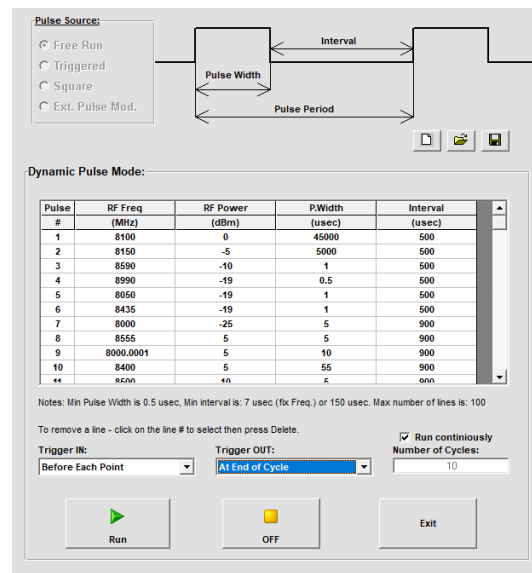
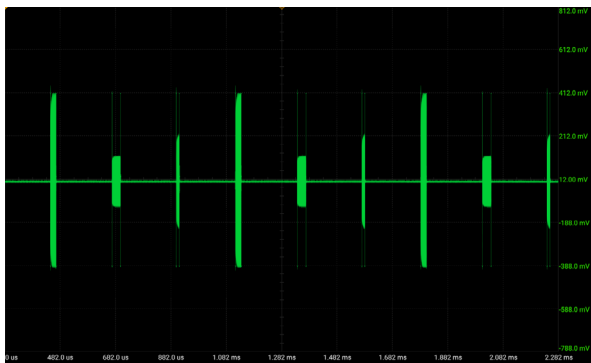



### FM MODULATION, +25°C

Parameter	Condition	Min.	Typ.	Max.	Unit
Modulation Shape	Sine or triangle wave				
Modulating Frequency	3 dB point	-	-	5	kHz
Max Frequency Deviation	-	-	10	-	MHz
Trigger Input Options	Free running				
Trigger Output Profile	-				

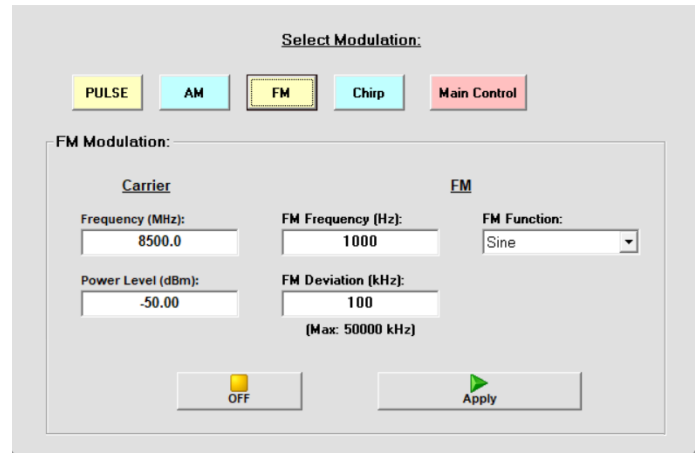
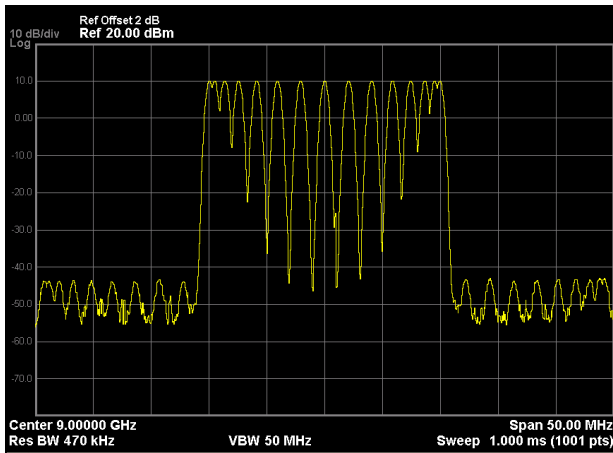

### AM MODULATION, +25°C

Parameter	Condition	Min.	Typ.	Max.	Unit
Modulation Depth <sup>18</sup>	-	0	-	100	%
Modulating Frequency	3 dB point	-	-	5	kHz
Trigger Input Options	Free running				
Trigger Output Profile	-				

18. Allow sufficient margin between the carrier power and generator's min / max limit to prevent signal distortion (eg: a modulation depth of 50% translates to a power range of +1.76 dB to -3.01 dB around the carrier level).

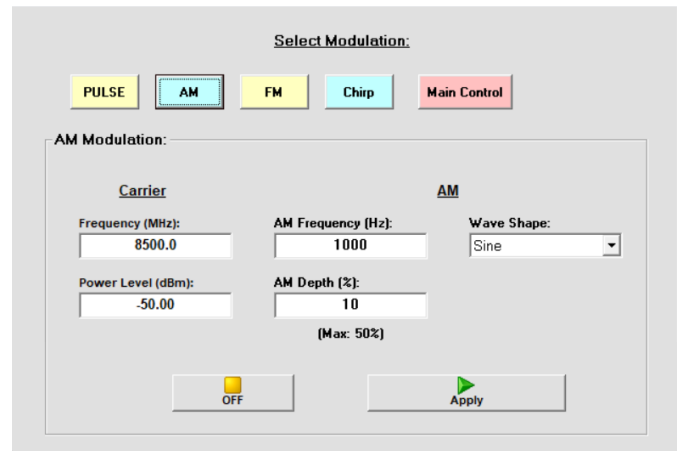
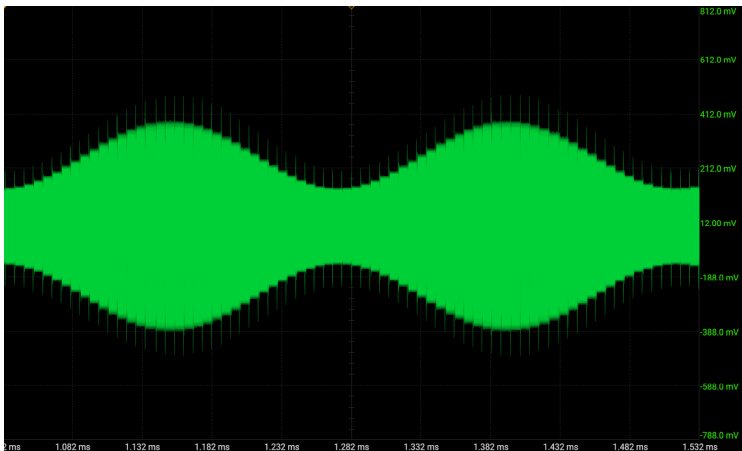



### TYPICAL PERFORMANCE GRAPHS (PER CHANNEL)

#### Power Accuracy vs. Output Frequency

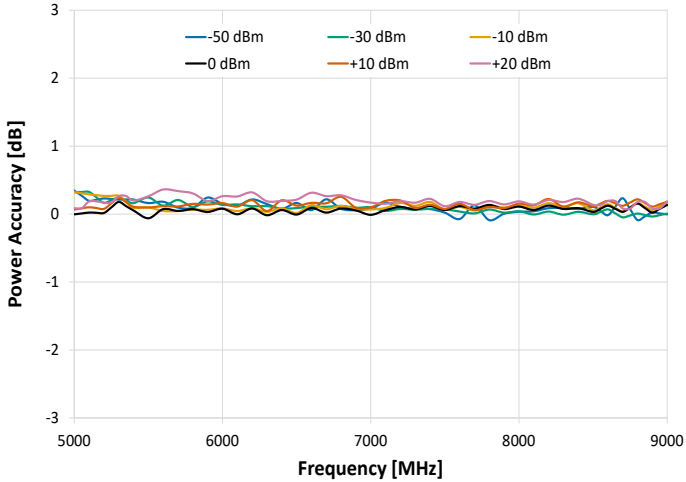

#### Power Accuracy vs. Output Power

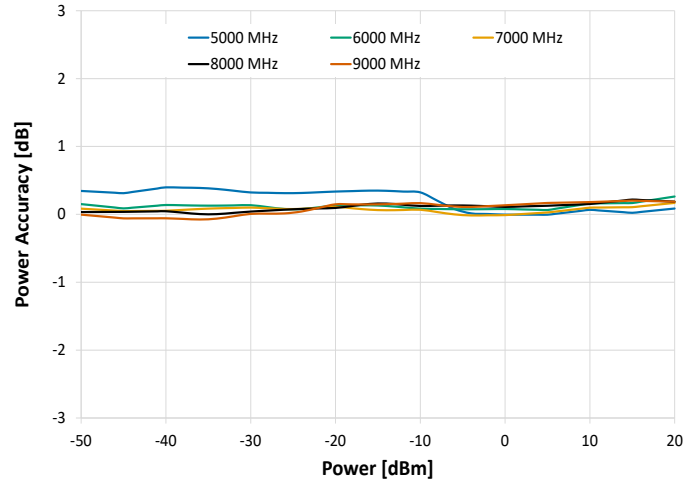

#### Max Power vs. Output Frequency

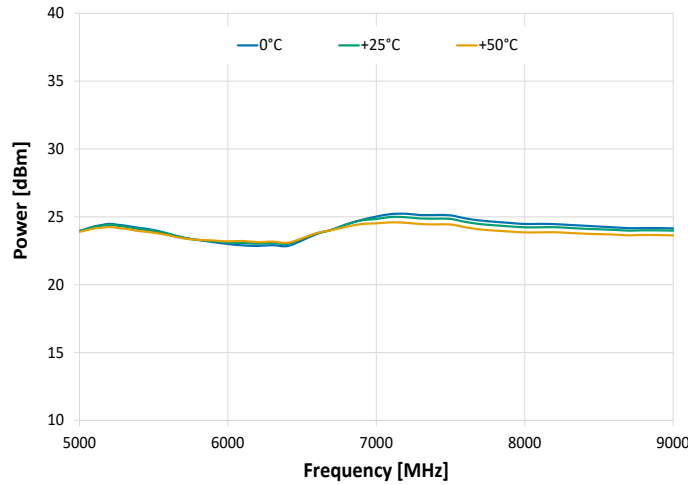

#### Phase Noise vs. Output Frequency

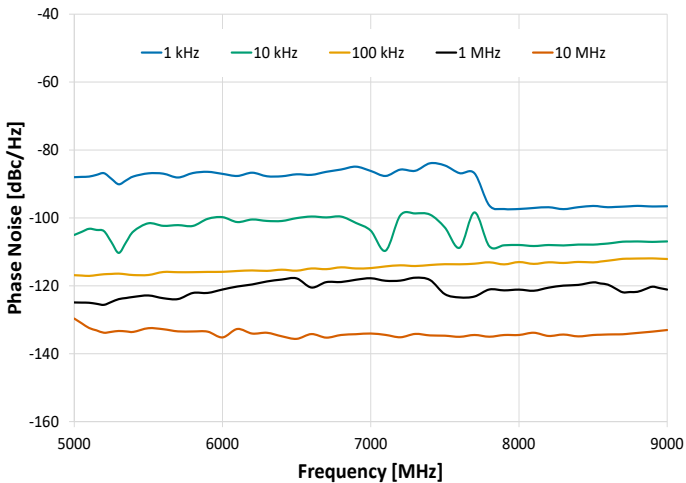

#### Phase Noise vs. Offset Frequency

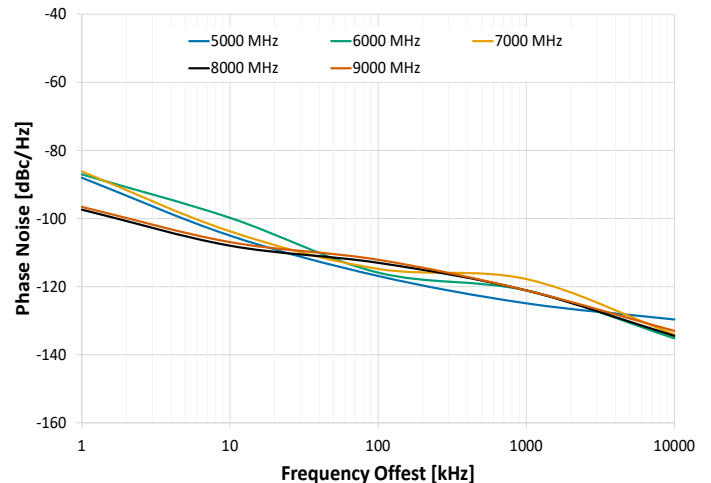



### TYPICAL PERFORMANCE GRAPHS (PER CHANNEL, CONTINUED)

#### Harmonics vs. Output Frequency @ +20 dBm

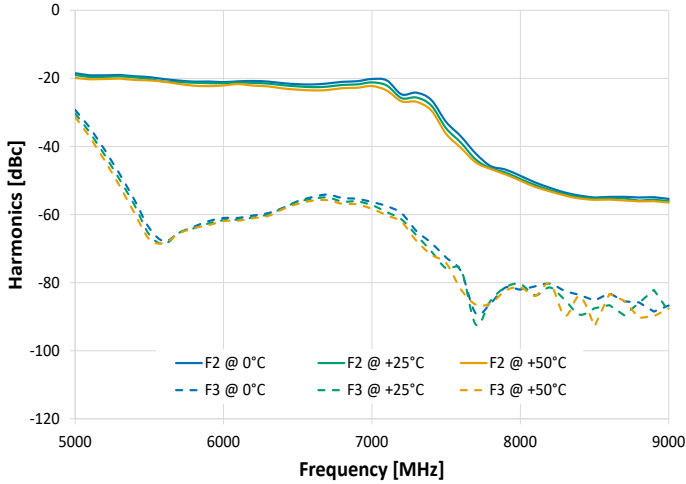

#### Harmonics vs. Output Frequency @ +10 dBm

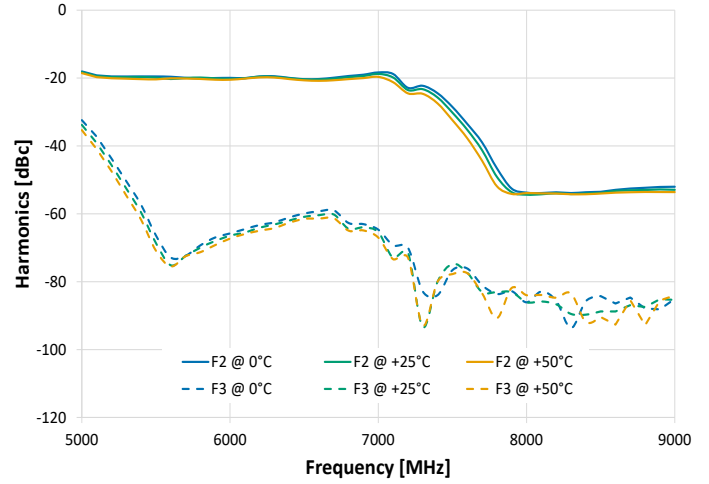

#### Harmonics vs. Output Frequency @ 0 dBm

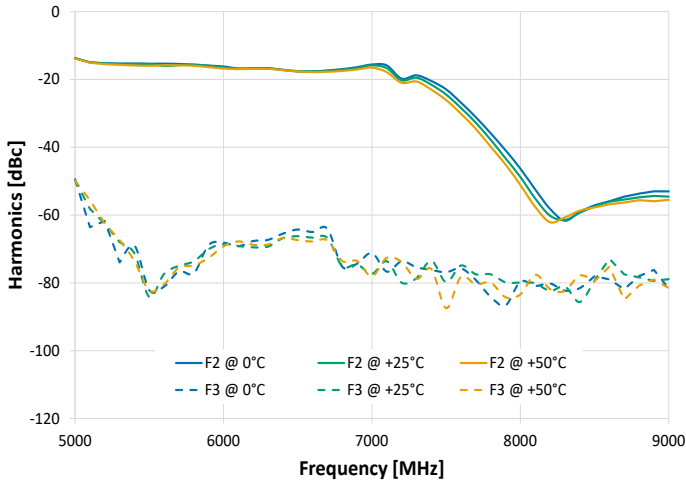

#### Harmonics vs. Output Frequency @ -20 dBm

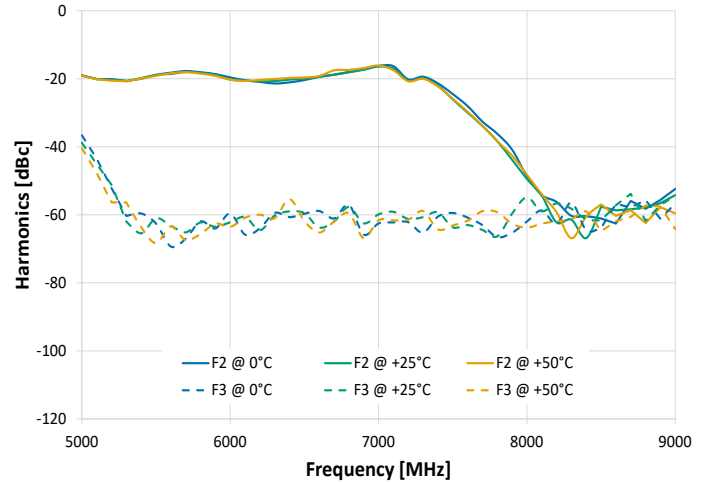

#### Spurious vs. Output Frequency (Offsets 100 kHz to 150 MHz @ +5 dBm)

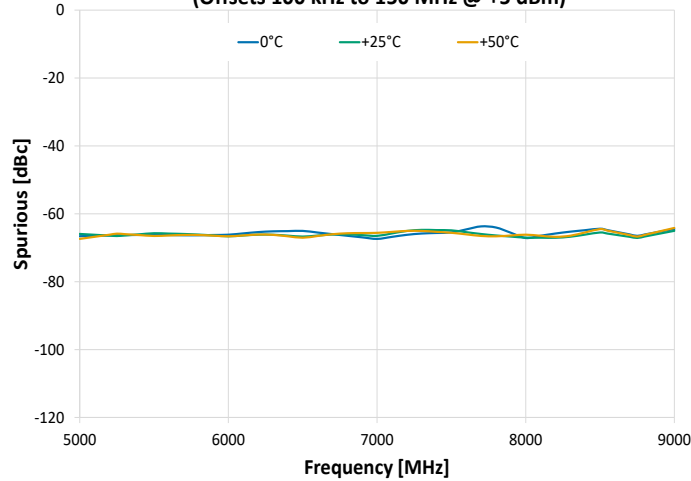



### CONTROL INTERFACES

Ethernet Control	Supported Protocols	TCP / IP, HTTP, Telnet, SSH, DHCP, UDP (limited)
	Max Data Rate	1 Gbps (1000 Base-T Full Duplex)
USB Control	Supported Protocols	HID (Human Interface Device) - High-speed
	Min Communication Time <sup>19</sup>	400 μs typ (full transmit/receive cycle)

19. USB Min Communication Time is based on the polling interval of the USB HID protocol (125 μs polling interval, 64 bytes per packet), medium CPU load and no other high-speed USB devices using the USB bus.

### SOFTWARE & DOCUMENTATION

Mini-Circuits' full software and support package including user guide, Windows GUI, API, programming manual and examples can be downloaded free of charge (refer to the last page for the download path).

A comprehensive set of software control options is provided:

- GUI for Windows – Simple software interface for control via Ethernet and USB.
- Programming / automation via Ethernet:
  - Complete set of control commands which can be sent via any supported protocol.
  - Simple to implement in the majority of modern programming environments.
- Programming / automation via USB:
  - DLL files provide a full API for Windows with a set of intuitive functions which can be implemented in any programming environment supporting .Net Framework or ActiveX.
  - Direct USB programming is possible in any other environment (not supporting .Net or ActiveX).

Please contact [testsolutions@minicircuits.com](mailto:testsolutions@minicircuits.com) for support.

### MINIMUM SYSTEM REQUIREMENTS

GUI	Windows 7 or later
USB API DLL	Windows 7 or later and programming environment with ActiveX or .NET support
USB Direct Programming	Linux, Windows 7 or later
HTTP, Telnet or SSH	Any computer with a network port and Ethernet-TCP/IP (HTTP, Telnet or SSH protocols) support
Hardware	Intel i3 (or equivalent) or later



### GRAPHICAL USER INTERFACE (GUI) FOR WINDOWS - KEY FEATURES

- Connect via USB or Ethernet
- Password protected access for safe remote usage over Ethernet

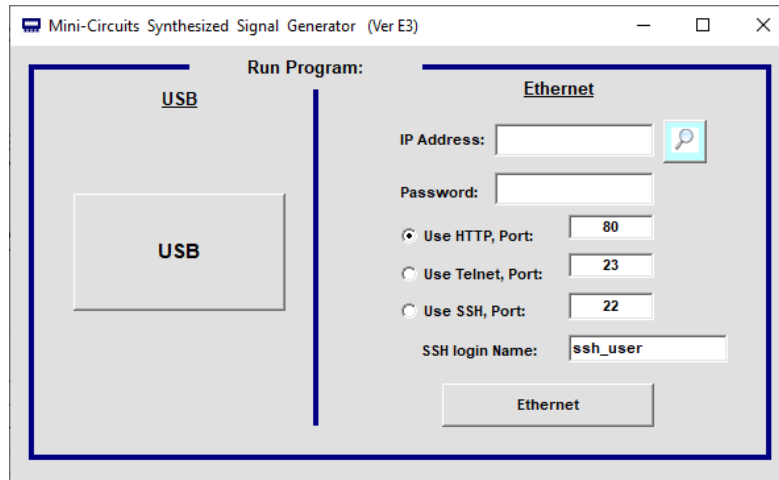

- Set all functions for each channel independently
- Configure output power, frequency, pulse modulation
- Program timed signal output sequences (linear sweep and frequency hop)
- Control timed sequences in multiple generators simultaneously
- Track unit operation time since last calibration and setup calibration reminders

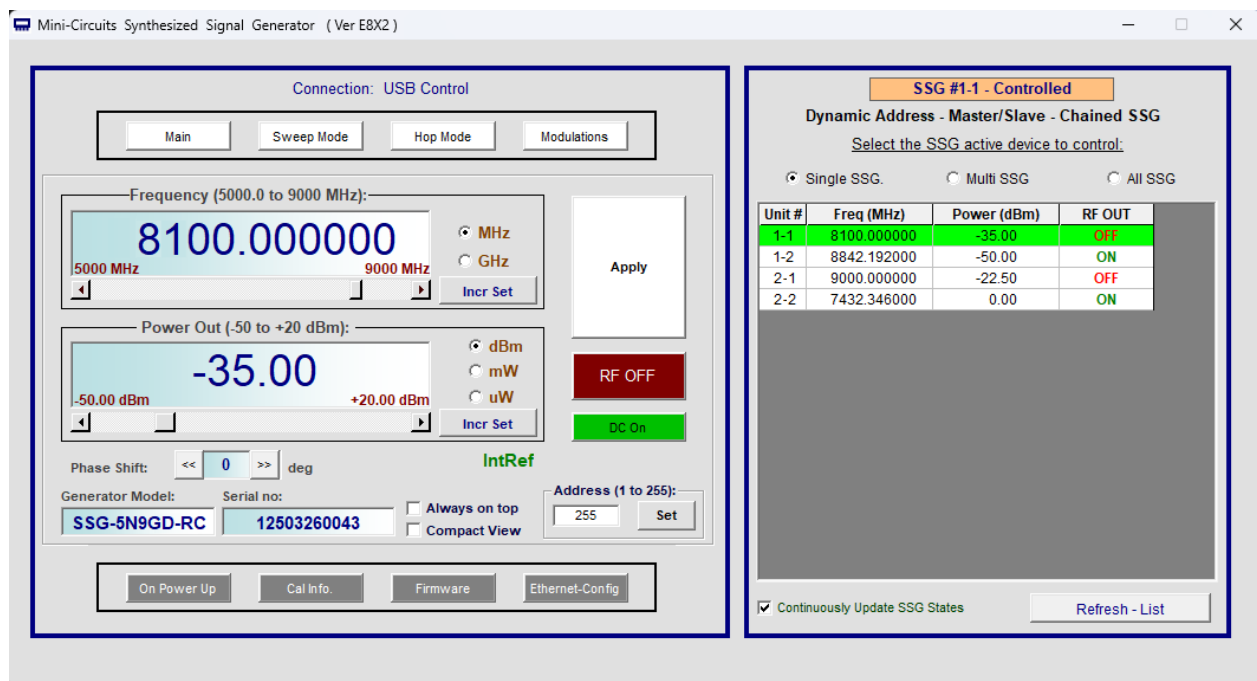



### AUTOMATED SWEEP / HOP SEQUENCES

- Set all functions for each channel independently
- Sweep across a frequency band at a fixed output power.
- Sweep output power levels at a fixed frequency.
- Hop through a list of pre-defined frequency / power settings.
- Set dwell times down to 10 μs in high speed mode.
- Run on demand or in response to external triggers.
- Produce triggers to signal switching points or completing a run.

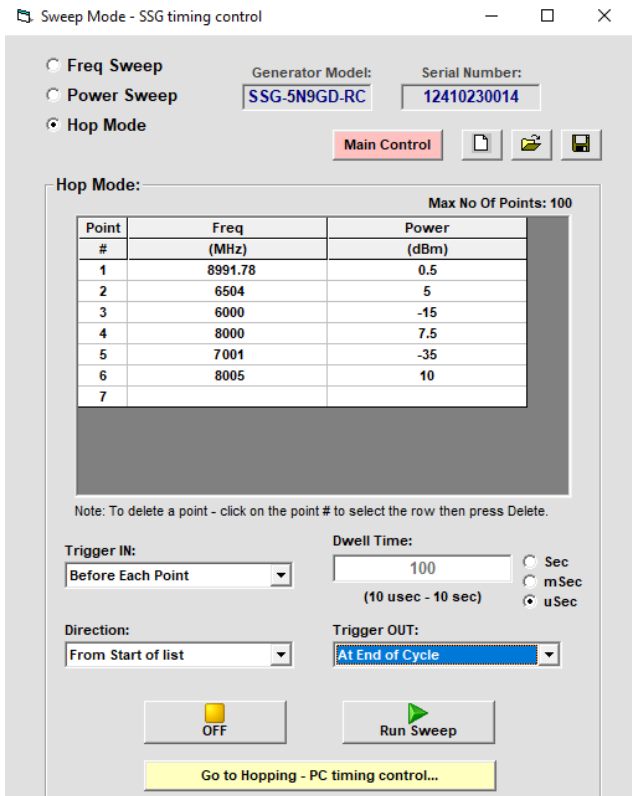

### SIGNAL MODULATION

- Select AM, FM, Chirp or Pulse modulation
- In the individual screens for each modulation specify the parameters for the modulated signal

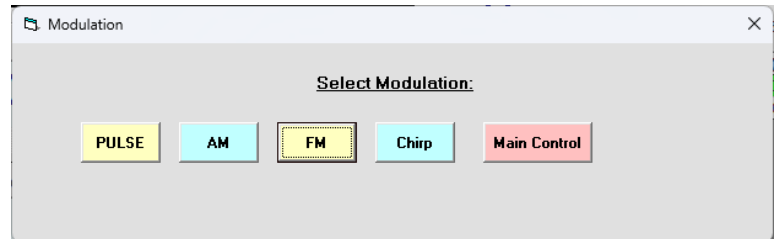



### CONNECTING MULTIPLE MODULES (DAISY CHAIN)

The model is designed to connect up to 25 modules in series (daisy chain) using dynamic addressing, meaning there is no need to specifically set the address of the modules. The addresses will be set automatically as part of establishing the communications with the computer. The module connected to the computer's USB port or Ethernet connection will be assigned address 0 (master), the first module connected to it will get address 1 (slave) and subsequent modules incrementing up to address 24 (slave).

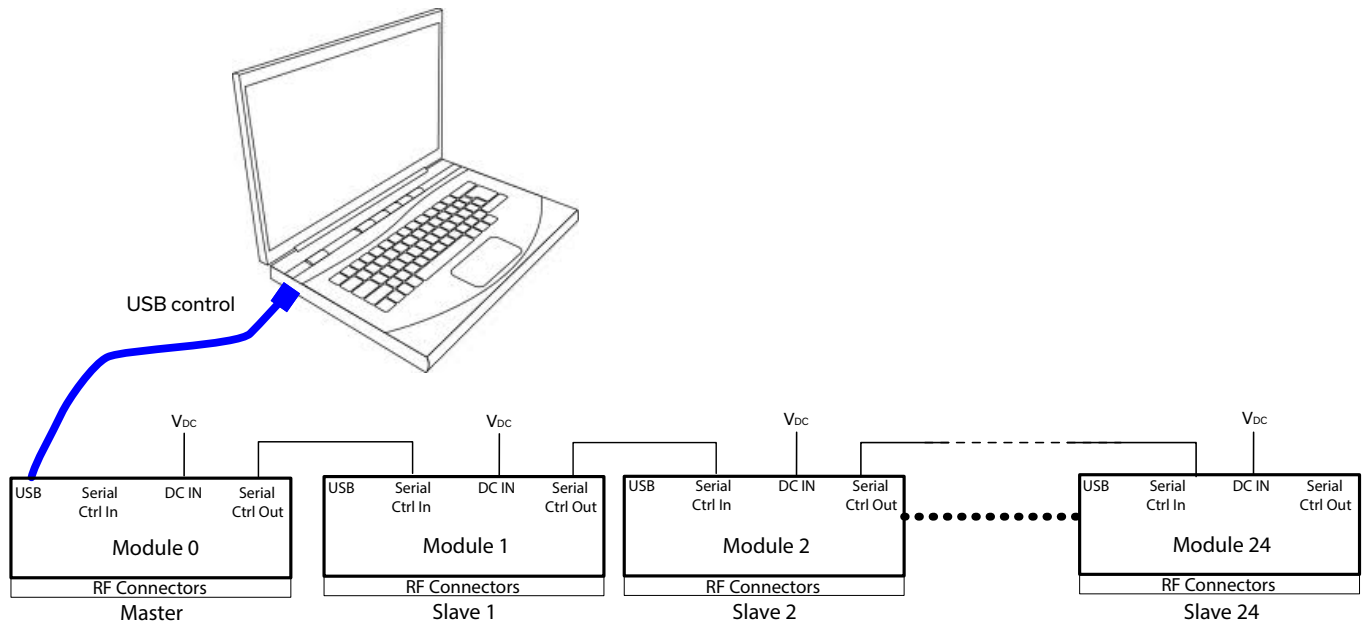

Connections between modules will be made using the serial in/out ports with the module connected to the PC act as a master and all other as slave modules. All control will be through the master module (address 0) which is the only one communicating with the PC or computer network. Serial control out port of each module should be connected to the serial control in port of the next module.

Power must be supplied to each module separately via their individual power supplies.

The serial master/slave bus allows connecting modules of different types to the same daisy chain as long as all support Mini-Circuits Dynamic addressing setup. To add a new module to the setup, simply connect the module and refresh the address listing, no need to reset any of the existing modules or assign addresses manually.



### BLOCK DIAGRAM

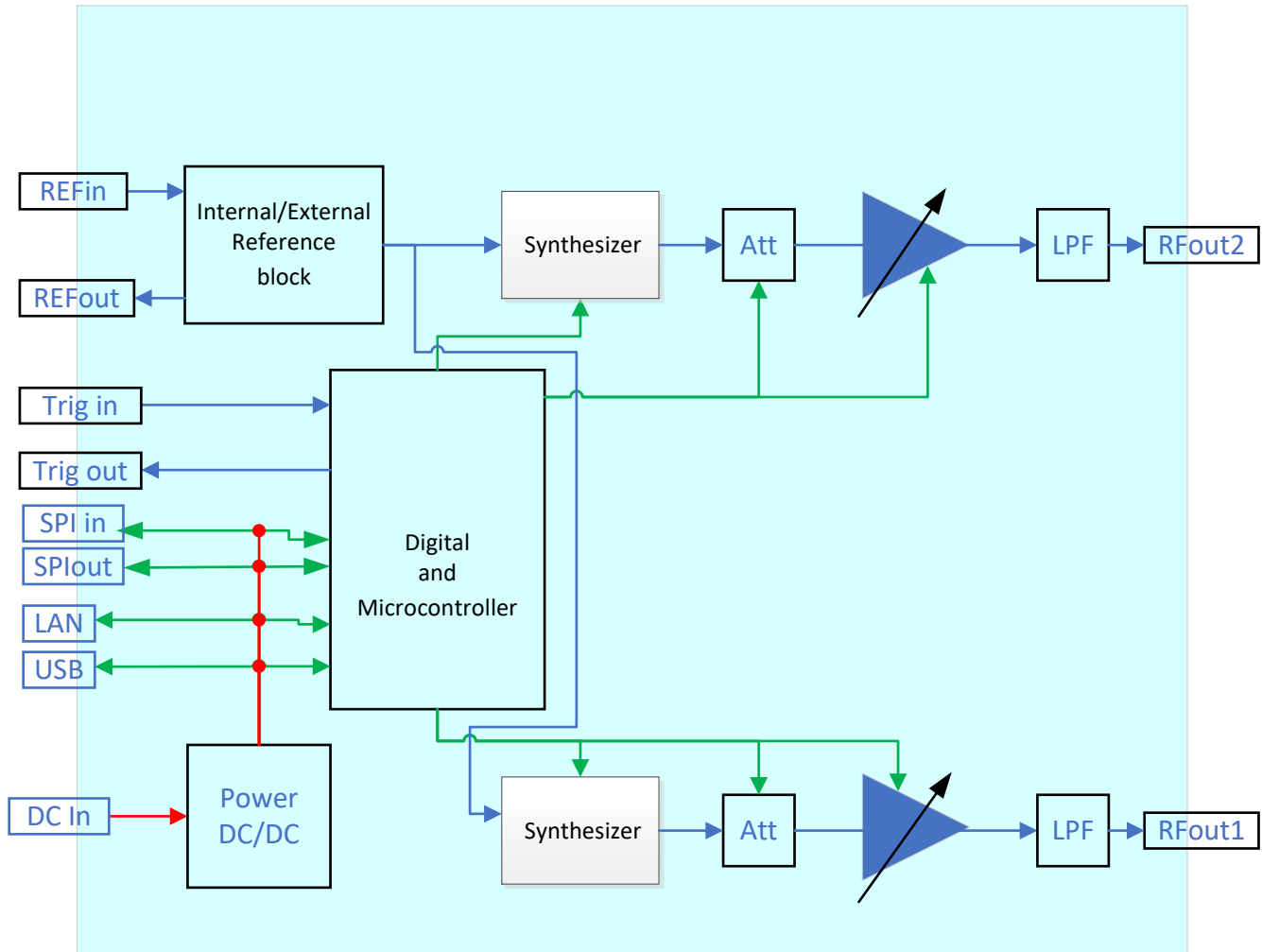

### CONNECTIONS

Port Name	Connector Type
RF output (RF1 & RF2)	SMA-Female
Reference in	J4 SMB-Male
Reference out	J5 SMB-Male
Trigger in	J3 SMB-Male
Trigger out	J2 SMB-Male
Power in <sup>20</sup>	2.1 mm DC socket
USB port	USB type C female
Network (Ethernet/LAN)	RJ45 socket
Serial Out (Digital Control 1 port)	Digital Snap Fit Connector <sup>21</sup>
Serial In (Digital Control 2 port)	Digital Snap Fit Connector <sup>21</sup>

20. No power On/Off switch - SSG will power on as soon as power is connected, starting at the specified startup condition (factory default set to 9000 MHz, -50 dBm, RF Off).

21. Mating connector is Hirose ST40X-10S-CV(30)



### OUTLINE DRAWING (SL3644)

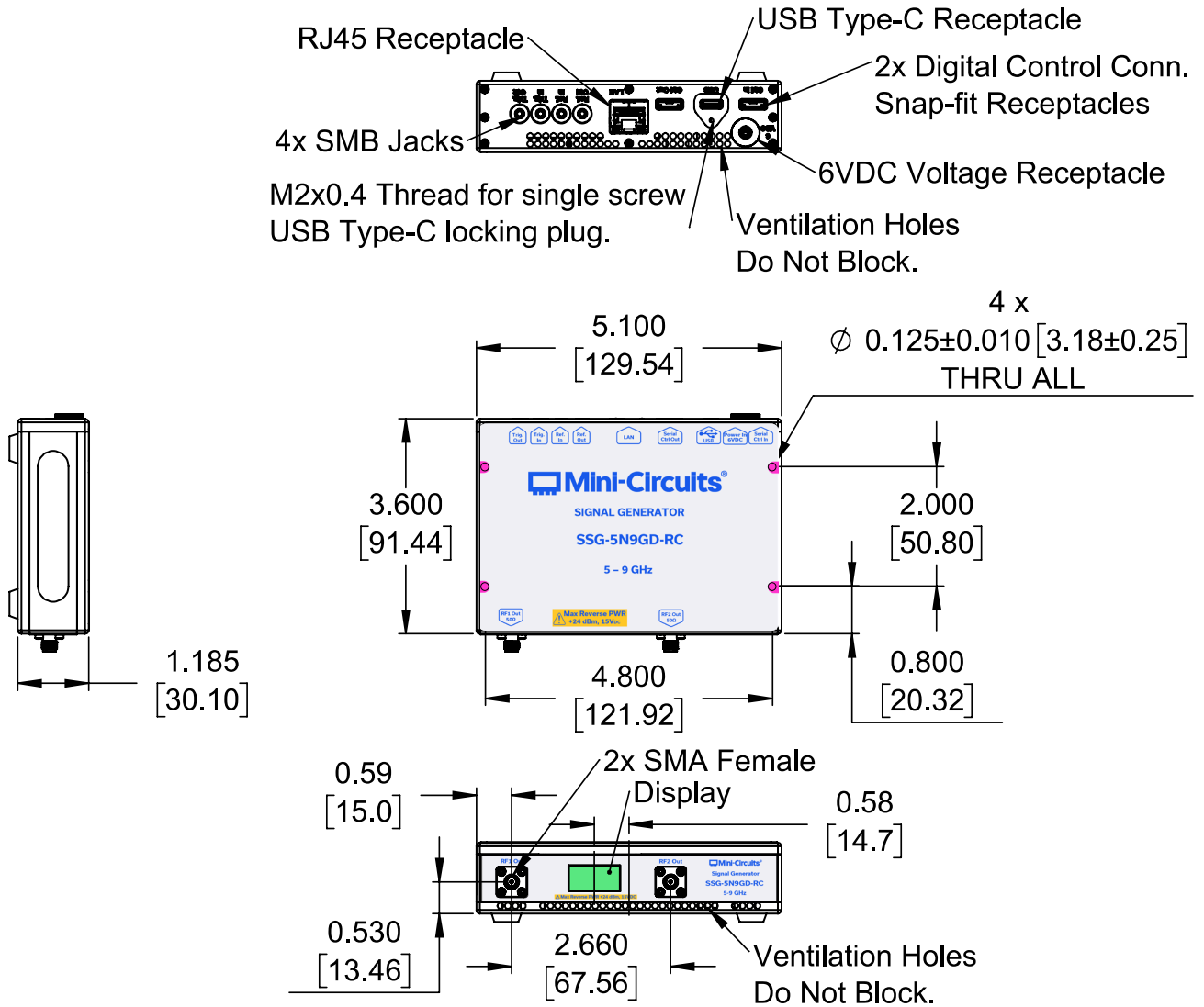

### NOTES:

1. Case material: Aluminum alloy.
2. Case Finish: Nickel Plate.
3. Weight: 600 grams
4. Marking may contain other features or characters for internal lot control.

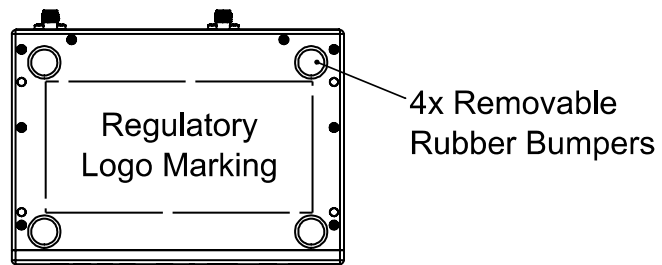



## USB & ETHERNET & DAISY-CHAIN

# Signal Generator

## SSG-5N9GD-RC





50Ω    5000 to 9000 MHz    -55 dBm to +23 dBm    SMA Female    Dual Channel

DETAILED MODEL INFORMATION IS AVAILABLE ON OUR WEBSITE [CLICK HERE](#)

Performance Data & Graphs	Data Graphs
Case Style	SL3644
Environmental Rating	ENV55
Software, User Guide & Programming Manual	<a href="https://www.minicircuits.com/softwaredownload/sg.html">https://www.minicircuits.com/softwaredownload/sg.html</a>
Regulatory Compliance	<p>Refer to user guide for compliance information</p>  <p><a href="https://www.minicircuits.com/app/AN49-003.pdf">https://www.minicircuits.com/app/AN49-003.pdf</a></p>
Support	<a href="mailto:testsolutions@minicircuits.com">testsolutions@minicircuits.com</a>

### INCLUDED ACCESSORIES <sup>22</sup>

	Part No.	Description	Qty.
	AC/DC-6-3W	AC/DC Grounded Power adapter, 0°C to +40°C AC Input: 100-240 V, 50/60 Hz, I <sub>Max</sub> = 1.2A DC Output 6±0.3 V, I <sub>Max</sub> = 3A	1
(See images below)	CBL-3W-xx	AC Power Cord (Select one power cord from below with each unit)	1
	USB-CBL-AC-7SC+	6.5 ft (2.0 m) USB Cable: USB type A (Male) to USB type C (Male) Includes a screw lock to securely fasten the USB cable to the module	1
	CBL-5FT-BMSMB+	5.0 ft (1.5 m) Trigger cable: BNC (Male) to SMB (Female)	2

22. Additional quantities are available for purchase as optional accessories.

### AC POWER CORD OPTIONS <sup>23</sup>

United States	Europe	United Kingdom	Australia and China	Israel
				
CBL-3W-US	CBL-3W-EU	CBL-3W-UK	CBL-3W-AU	CBL-3W-IL

23. Select one option from the list with each unit. Please contact [testsolutions@minicircuits.com](mailto:testsolutions@minicircuits.com) if your region is not listed.





## USB & ETHERNET & DAISY-CHAIN





# Signal Generator

## SSG-5N9GD-RC



50Ω    5000 to 9000 MHz    -55 dBm to +23 dBm    SMA Female    Dual Channel

### OPTIONAL ACCESSORIES

	Part No.	Description
	CBL-RJ45-MM-5+	5.0 ft (1.5 m) Ethernet cable: RJ45 (Male) to RJ45 (Male) Cat 5E cable
	CBL-5FT-MMD+	5.0 ft (1.5 m) Cable assembly for serial control daisy chain with snap fit connectors
	CBL-1.5FT-MMD+	1.5 ft (0.45 m) Cable assembly for serial control daisy chain with snap fit connectors
	<a href="#">VLF-8400+</a>	LTCC Filter: Low pass filter (50Ω), providing good harmonics at DC - 8400 MHz

### CALIBRATION SERVICE

The recommended factory calibration interval is every 2 years. Mini-Circuits offers a proprietary factory calibration service using equipment with traceability to national standards. All units are calibrated to this standard prior to shipment.

Additionally, this model can be calibrated independently by accredited third-party calibration laboratories with options for ISO-17025 and on-site service. Contact [testsolutions@minicircuits.com](mailto:testsolutions@minicircuits.com) for recommendations or details of the calibration process.

Part No.	Description
CALSSG-5N9GD-RC	Calibration Service for SSG-5N9GD-RC <a href="#">CLICK HERE</a>

#### NOTES:

- A. Performance and quality attributes and conditions not expressly stated in this specification document are intended to be excluded and do not form a part of this specification document.
- B. Electrical specifications and performance data contained in this specification document are based on Mini-Circuit's applicable established test performance criteria and measurement instructions.
- C. The parts covered by this specification document are subject to Mini-Circuits standard limited warranty and terms and conditions (collectively, "Standard Terms"); Purchasers of this part are entitled to the rights and benefits contained therein. For a full statement of the Standard Terms and the exclusive rights and remedies thereunder, please visit Mini-Circuits' website at <https://www.minicircuits.com/terms/viewterm.html>

