

Synthesized Signal Generator

SSG-6000RC

50Ω -65 dBm to +14 dBm, 25-6000 MHz

The Big Deal

- **USB or Ethernet-TCP/IP** (HTTP and Telnet protocols) control
- Wideband generator with 3 Hz frequency resolution
- 79 dB adjustable output power range
- Internal & external pulse modulation
- Configurable power up settings

Applications

- Lab test equipment
- Automated test capability
- Field testing and remote operation via internet
- Production line testing



Generic photo used for illustration purposes only

Case Style: LV1913



Software Package

Included Accessories

Model No.	Description	Qty.
AC/DC-12-3W	AC/DC 12V adaptor (see Ordering Information)	1
CBL-3W-xx	AC power cord (see Ordering Information)	1
USB-CBL-AB-3+	2.7 ft. USB cable	1
CBL-RJ45-MM-5+	5 ft. network cable	1

See our web site for RoHS Compliance methodologies and qualifications

Product Overview

Mini-Circuits SSG-6000RC is a wideband synthesized signal generator operating over a frequency range of 25 to 6000 MHz. The signal generator is cased in a rugged metal shielded package (11" x 8.5" x 2.15") and equipped with an N-type 50Ω connector at the RF output port.

Full software support is provided, including our user-friendly GUI application for Windows and a full API and programming instructions for both Windows and Linux environments (32-bit and 64-bit systems). The latest version of the full software package can be downloaded from <https://www.minicircuits.com/softwaredownload/sg.html> at any time.

Included with the generator are a 2.7 ft. USB cable, a 5 ft. Ethernet cable and a 12V power adapter. Longer USB cables and a mounting bracket are available as additional options.

Key Features

Feature	Advantages
Wide output power dynamic range	Dynamic range 79 dB, output power from -65 dBm to +14dBm in 0.25dB steps
USB & Ethernet control	USB HID and Ethernet (HTTP / Telnet) interfaces provide easy compatibility with a wide range of software setups and programming environments
Pulse modulation options	The SSG-6000RC can produce pulse modulated RF using internal or external modulating signal
Multiple sweep options	The SSG-6000RC can be set to sweep either power or frequency up, down, or bidirectionally.
Fine frequency resolution (3 Hz)	Allows precisely setting the desired signal, simplifying test setups

Trademarks: Windows is a registered trademark of Microsoft Corporation in the United States and other countries. Linux is a registered trademark of Linus Torvalds. Pentium is a registered trademark of Intel Corporation. Neither Mini-Circuits nor the Mini-Circuits SSG-series Synthesized Signal Generators are affiliated with or endorsed by the owners of the above referenced trademarks

Mini-Circuits and the Mini-Circuits logo are registered trademarks of Scientific Components Corporation.

Rev. F
ECO-009621
EDR-110572
SSG-6000RC
RAV
200909
Page 1 of 9



Electrical Specifications (General RF) at +25°C

Parameter	Test Conditions		Min.	Typ.	Max.	Units
Output Frequency	-		25	-	6000	MHz
Frequency Resolution ¹	25 - 3000 MHz		-	3	-	Hz
	3000 - 6000 MHz		-	6	-	Hz
Frequency accuracy	Using Internal Reference		-	±1	-	ppm
Settling time ^{2,4}	-		-	1.5	2.0	msec
Dwell time (nominal) ^{3,4}	-		20	-	10,000	
VSWR	25 - 2150 MHz		-	1.35	2.3	:1
	2150 - 4000 MHz		-	1.75	2.6	
	4000 - 6000 MHz		-	1.50	2.4	
Output power Max ⁵	25 - 6000 MHz		+10	+14	-	dBm
Output power Min ⁵	25 - 3000 MHz		-	-65	-60	dBm
	3000 - 5400 MHz		-	-60	-55	
	5400 - 6000 MHz		-	-60	-50	
Output power resolution (nom.)	-		-	0.25	-	dB
Dynamic range	-		-	79	-	dB
Output power accuracy	25 - 3000 MHz	PWR _{out} : -60 to +10 dBm	-	±0.20	±1.00	dB
	3000-4000 MHz	PWR _{out} : -55 to +10 dBm	-	±0.20	±1.00	
	4000 - 5400 MHz	PWR _{out} : -55 to +10 dBm	-	±0.25	±1.30	
	5400 - 6000 MHz	PWR _{out} : -50 to +10 dBm	-	±0.25	±1.30	
RF output level	@ RF OFF		-	-120	-	dBm
Harmonics & Sub-Harmonics ⁶	25-3000 MHz	-60 to -30 dBm	-	-44	-	dBc
		-30 to 0 dBm	-	-64	-	
		0 to +10 dBm	-	-51	-	
	3000-4500 MHz	-55 to -30 dBm	-	-34	-	
		-30 to 0 dBm	-	-38	-	
		0 to +10 dBm	-	-34	-	
	4500-6000 MHz	-55 to -30 dBm	-	-43	-	
		-30 to 0 dBm	-	-51	-	
		0 to +10 dBm	-	-35	-	
Non-Harmonic Spurious	-		-	-60	-50	dBc
Ethernet communication	Supports both Telnet and HTTP protocols over TCP/IP					

¹ Tested with external reference

² Settling time - transition time between 2 output states. During the transition, RF output is turned off to avoid transient outputs.

³ Dwell time - duration of each signal point in a Sweep or Hop sequence set by user. Default is minimum dwell time.

⁴ Generator response time is Dwell time + Settling Time.

⁵ Generator units are calibrated within typical power range, however performance is guaranteed only within power max/min limits.

⁶ Generator Sub-Harmonics(F0.5, F1.5, F2.5, etc...) are produced only in the 3000-6000 MHz range.

Typical Phase Noise, SSB (dBc/Hz) at +25°C

Carrier Frequency (MHz)	Frequency Offset				
	100 Hz	1 kHz	10 kHz	100 kHz	1 MHz
25	-121	-134	-142	-149	-155
46.875	-118	-132	-137	-145	-157
93.75	-113	-127	-131	-139	-157
187.5	-105	-121	-125	-133	-156
375	-101	-115	-119	-127	-153
750	-94	-108	-112	-121	-150
1000	-93	-106	-110	-115	-147
1500	-89	-102	-107	-115	-144
2000	-85	-100	-104	-110	-141
2500	-83	-97	-103	-104	-138
3000	-82	-95	-99	-102	-136
3500	-80	-95	-99	-103	-134
4000	-80	-94	-98	-103	-135
4500	-79	-93	-95	-105	-134
5000	-77	-93	-97	-98	-132
6000	-75	-90	-94	-97	-130

Electrical Specifications (Pulse modulation modes) at +25°C

Parameter	Test Conditions	Min.	Typ.	Max.	Units
Pulse Width	Nominal value	10	-	-	µSec
Pulse Period	Measured at the 50% points	11	-	10e7	µSec
Duty cycle (in Free Run)	Pulse Width divided by Pulse Period	0.01	-	99.99	%
Rise / Fall time (Internal modulation)	Measured between 10% and 90%	-	800 / 30	-	nSec
Pulse Width Accuracy	Measured at 50% of pulse level for Internal and external modulation	-	±1	-	%
External pulse mod. input threshold	External pulse modulation	-	-	2.4	V
Trigger response delay	Trigger edge to 50% of pulse level	Internal Pulse source ⁷	3.5	-	µSec
		External Pulse source	1.8	-	
Pulse Power ratio	@PWR _{OUT} =+10dBm, FREQ _{OUT} =25 MHz	-	60	-	dB
Pulse Power ratio	@PWR _{OUT} =+10dBm, FREQ _{OUT} =6000 MHz	-	45	-	

⁷ Max trigger frequency is 70 kHz

Electrical Specifications at +25°C (Reference, Trigger & DC power)

Parameter	Test Conditions	Min.	Typ.	Max.	Units	
Reference In	Frequency	-	10	-	MHz	
	Power	-3.5	-	+7.5	dBm	
	Phase Noise	@ 10 kHz offset	-	-145	-	dBc/Hz
Reference Out	Frequency	-	10	-	MHz	
	Freq. Accuracy	Using Internal Reference	-	±1	-	ppm
	Power	-	+6	-	dBm	
Trigger Out, Low	-	0	-	0.4	V	
Trigger Out, High	-	2.4	-	3.3		
Trigger In, Low	-	0	-	0.4		
Trigger In, High	-	2.4	-	3.3		
Supply Voltage ⁸	-	11.4	12	12.6	V _{DC}	
Supply Current ⁸	-	-	700	850	mA	
USB current ⁸	SSG-6000RC does not draw power from the USB bus, only from the DC power adapter				mA	

⁸ Power On Sequence: Connect the 12V power, followed by the USB or Ethernet control before turning on the Generator.

Absolute Maximum Ratings

Operating Temperature	0°C to +50°C
Storage Temperature	-20°C to +60°C
Power in @ Reference In	+10 dBm
Reverse Power(DC) @ Reference Out	8 V _{DC}
Reverse Power(DC) @ RF Out	8 V _{DC}
Voltage input to Trigger ports	-0.3V _{DC} to +3.5V _{DC}

Permanent damage may occur if any of these limits are exceeded. Operating in the range between operating power limits and absolute maximum ratings for extended periods of time may result in reduced life and reliability.

Connections

RF Output	(N Type-Female)
Ref. In	(BNC-Female)
Ref. Out	(BNC-Female)
Trigger In	(BNC-Female)
Trigger Out	(BNC-Female)
Power In	(2.1 mm DC socket)
USB Port	(USB type B female)
Network (Ethernet/LAN)	(RJ45 socket)

Typical Performance Curves*

*at +25°C unless noted otherwise

Harmonics & Sub-Harmonics Levels Vs. Output Frequency PWR=-50dBm

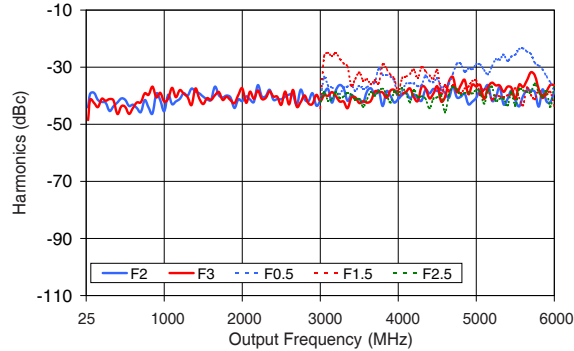

Harmonics & Sub-Harmonics Levels Vs. Output Frequency PWR=-30dBm

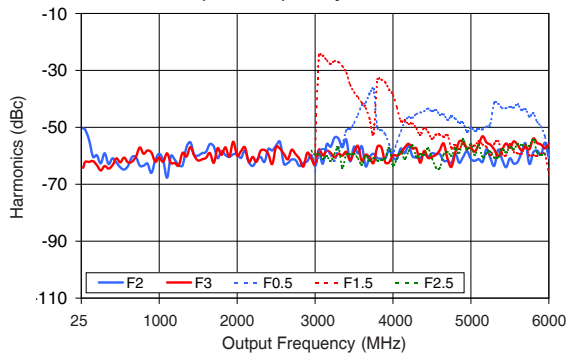

Harmonics & Sub-Harmonics Levels Vs. Output Frequency PWR=-20dBm

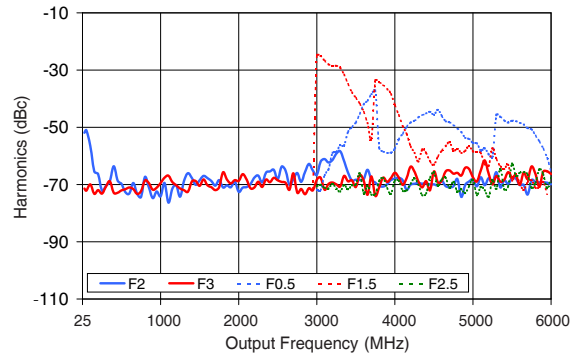

Harmonics & Sub-Harmonics Levels Vs. Output Frequency PWR=0dBm

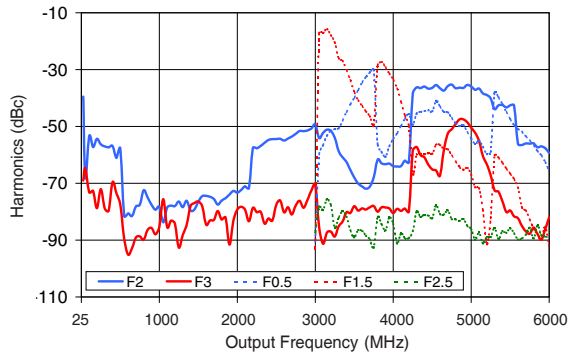

Harmonics & Sub-Harmonics Levels Vs. Output Frequency PWR=+10dBm

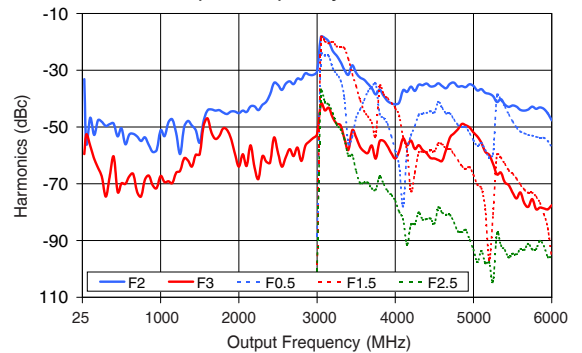

Typical Performance Curves* (continued)

*at +25°C unless noted otherwise

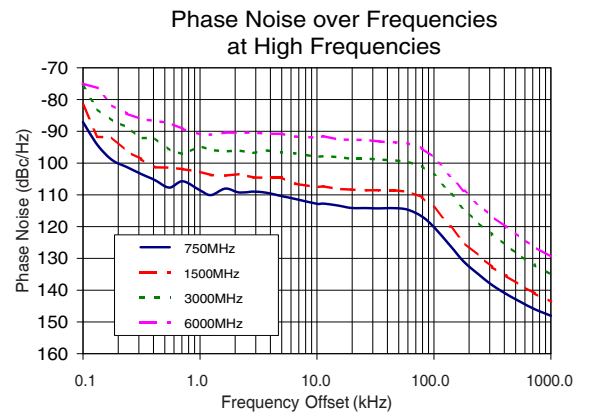
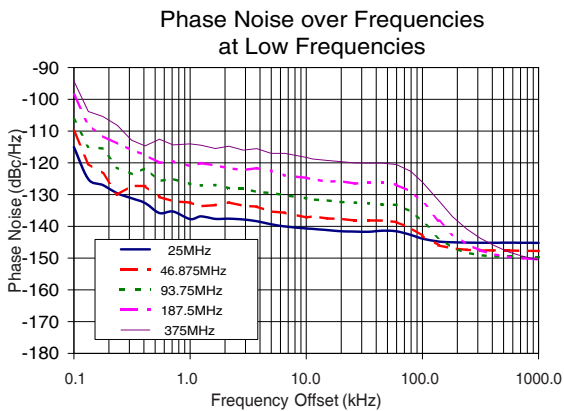
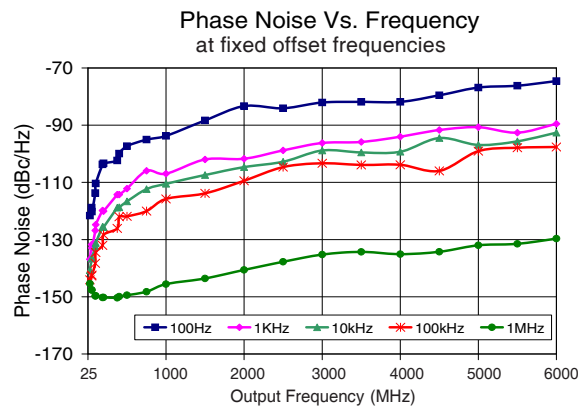
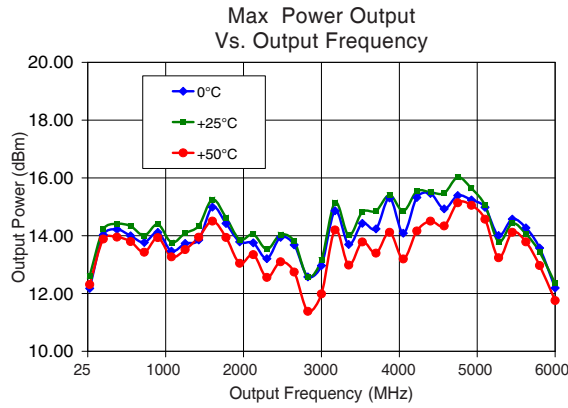

Typical Performance Curves* (continued)

*at +25°C unless noted otherwise

Spurious @Negative Offset & Low Freq Output Vs Frequency Offset

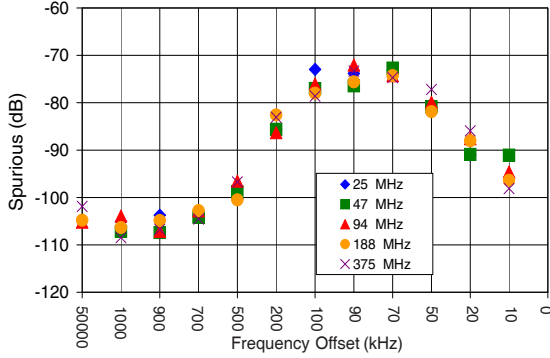

Spurious @Positive Offset & Low Freq Output Vs Frequency Offset

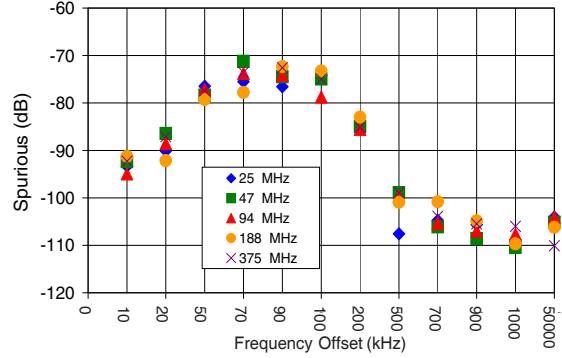

Spurious @Negative Offset & High Freq Output Vs Frequency Offset

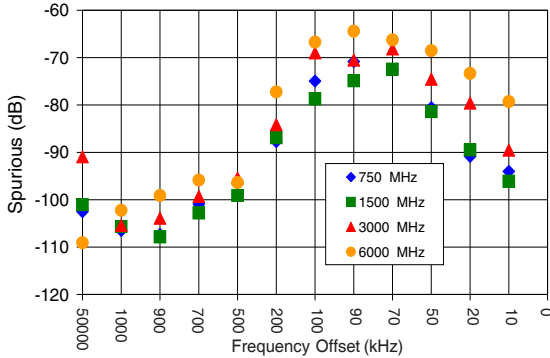

Spurious @Positive Offset & High Freq Output Vs Frequency Offset

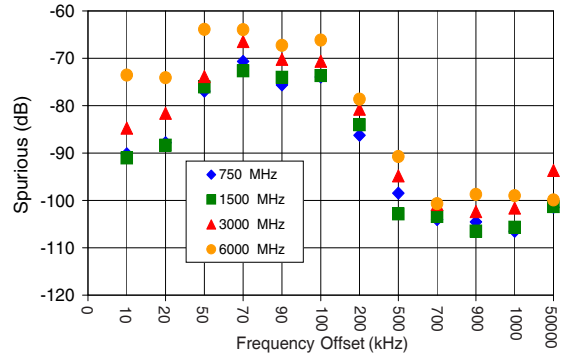

Power Accuracy Vs. Output Frequency

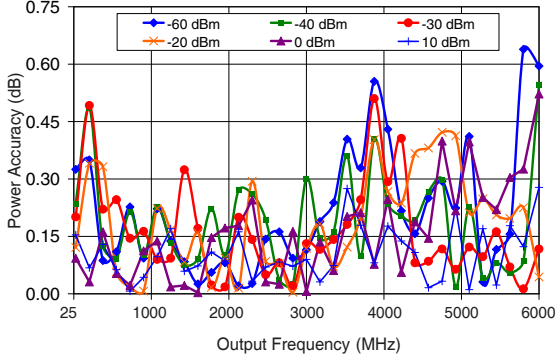

Power Accuracy Vs. Output Power

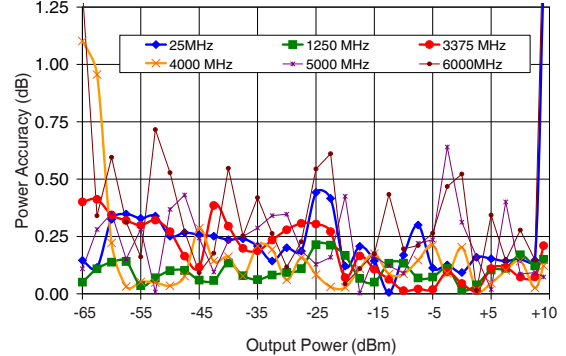

Outline Drawing LV1913

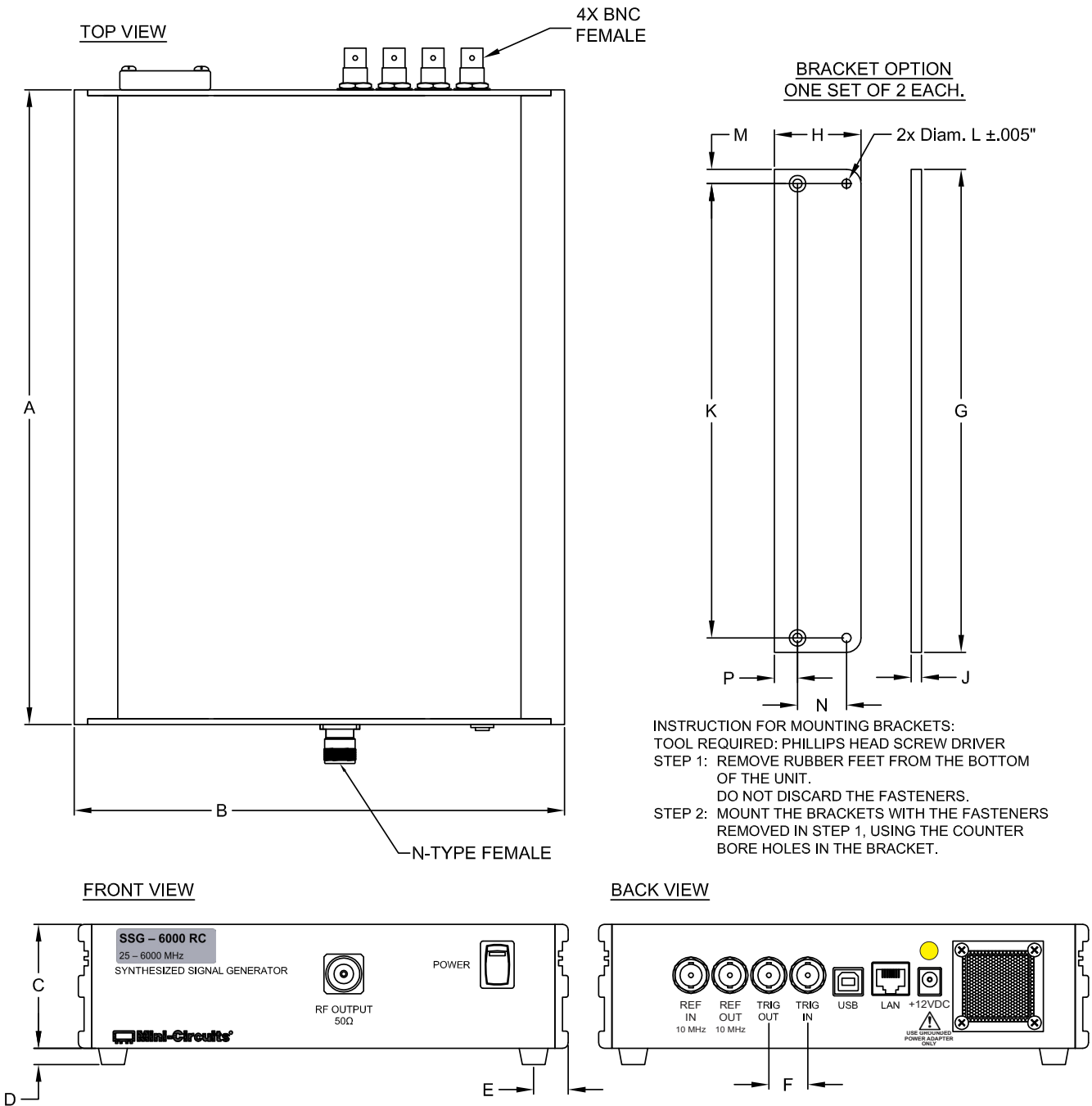

Outline Dimensions (inch / mm)

A	B	C	D	E	F	G	H	J	K	L	M	N	P	WT. GRAMS
11.00	8.50	2.15	0.28	0.60	0.68	8.37	1.50	0.18	7.870	0.158	0.25	0.850	0.40	2500
279.4	215.9	54.6	7.1	15.2	17.27	212.6	38.1	4.6	199.9	4.0	6.35	21.6	10.2	

Software & Documentation Download:

- Mini-Circuits' full software and support package including user guide, Windows GUI, DLL files, programming manual and examples can be downloaded free of charge from <https://www.minicircuits.com/softwaredownload/sg.html>
- Please contact testsolutions@minicircuits.com for support

Minimum System Requirements

Parameter	Requirements	
Interface	USB HID or HTTP Get/Post or Telnet protocols	
System requirements	GUI:	Windows 32 & 64 bit systems from Windows 98 up to Windows 10
	USB API (ActiveX & .Net)	Windows 32 & 64 bit systems with ActiveX or .Net support from Windows 98 up to Windows 10
	USB direct programming support	Linux, Windows systems from Windows 98 up to Windows 10
	HTTP or Telnet	Any computer with a network port and Ethernet-TCP/IP (HTTP or Telnet protocols) support
Hardware	Pentium® II or better	

Graphical User Interface (GUI) for Windows

Key Features:

- Set frequency and power
- Configure generator state at power-up
- Track operating time since last calibration and set reminder for calibration.
- Freq. & Power sweeps, up, down and bi-directional
- Pulse modulation signals
- Synchronize frequency and power sweeps from up to 4 generators.
- USB, HTTP or Telnet control of SSG
- Setting Ethernet configuration

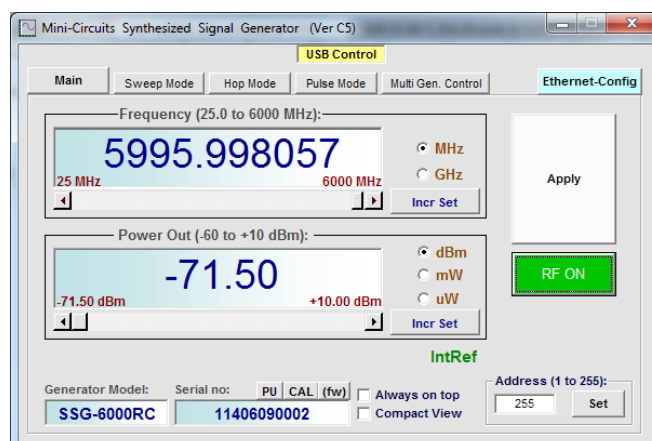

Application Programming Interface (API)

Windows Support:



- API DLL files exposing the full power sensor functionality
 - ActiveX COM DLL file for creation of 32-bit programs
 - .Net library DLL file for creation of 32 / 64-bit programs
- HTTP Get/Post and Telnet protocols use SCPI commands to provide full control.
- Supported by most common programming environments (refer to application note [AN-49-001](#) for summary of tested environments)





Linux Support:

- Full power sensor control in a Linux environment is achieved by way of USB interrupt commands.

Ordering, Pricing & Availability Information see our web site

Model	Description
SSG-6000RC	USB/Ethernet Synthesized Signal Generator

Included Accessories	Part No.	Description
	AC/DC-12-3W	AC/DC 12V _{DC} Grounded Power Adaptor. Operating temperature: 0°C to +40°C, I _{Max} =5A
	CBL-3W-xx	AC Power Cord (<i>Select one power cord from below with each Signal Generator</i>)
	USB-CBL-AB-3+	2.7 ft (0.8 m) USB Cable: USB type A(Male) to USB type B(Male)
	CBL-RJ45-MM-5+	5 ft. network cable: RJ45(Male) to RJ45(Male) Cat 5E cable.

AC Power Cords ⁹	Part No.	Description
	CBL-3W-US	Power Cord for United States
	CBL-3W-EU	Power Cord for Europe
	CBL-3W-UK	Power Cord for United Kingdom
	CBL-3W-AU	Power Cord for Australia and China
	CBL-3W-IL	Power Cord for Israel

⁹ Power cords for other countries are also available, if you need a power cord for a country not listed in the table please contact testsolutions@minicircuits.com for support. .

Optional Accessories	Description
USB-CBL-AB-3+ (spare)	2.7 ft. (0.8 m) USB cable
USB-CBL-AB-7+	6.8 ft. (2.1 m) USB Cable
USB-CBL-AB-11+	11 ft. (3.4 m) USB Cable
BKT-280-06+	Bracket (One set of 2 each)

Calibration	Description
CALSSG-6000RC	Calibration Service Click Here

Additional Notes

- A. Performance and quality attributes and conditions not expressly stated in this specification document are intended to be excluded and do not form a part of this specification document.
- B. Electrical specifications and performance data contained in this specification document are based on Mini-Circuit's applicable established test performance criteria and measurement instructions.
- C. The parts covered by this specification document are subject to Mini-Circuits standard limited warranty and terms and conditions (collectively, "Standard Terms"); Purchasers of this part are entitled to the rights and benefits contained therein. For a full statement of the Standard Terms and the exclusive rights and remedies thereunder, please visit Mini-Circuits' website at www.minicircuits.com/MCLStore/terms.jsp