

# Synthesized Signal Generator

**SSG-6001RC**

50Ω -70 dBm to +15 dBm, 1-6000 MHz

## The Big Deal

- **USB or Ethernet-TCP/IP** (HTTP and Telnet protocols) control
- Wideband generator with 3 Hz frequency resolution
- 85 dB adjustable output power range
- Internal & external pulse modulation
- Configurable power up settings

## Applications

- Lab test equipment
- Automated test capability
- Field testing and remote operation via internet
- Production line testing



Case Style: LV1913



Software Package

### Included Accessories

Model No.	Description	Qty.
AC/DC-12-3W1	AC/DC 12V adaptor (see Ordering Information)	1
CBL-3W1-xx	AC power cord (see Ordering Information)	1
USB-CBL-AB-3+	2.7ft. USB cable	1
CBL-RJ45-MM-5+	5 ft. network cable	1

### RoHS Compliant

See our web site for RoHS Compliance methodologies and qualifications

## Product Overview

Mini-Circuits SSG-6001RC is a wideband synthesized signal generator operating over a frequency range of 1 to 6000 MHz. The signal generator is cased in a rugged metal shielded package (11" x 8.5" x 2.15") and equipped with an N-type 50Ω connector at the RF output port.

Full software support is provided, including our user-friendly GUI application for Windows and a full API and programming instructions for both Windows and Linux environments (32-bit and 64-bit systems). The latest version of the full software package can be downloaded from <https://www.minicircuits.com/softwaredownload/sg.html> at any time.

Included with the generator are a 2.7 ft. USB cable, a 5 ft. Ethernet cable and a 12V power adapter. Longer USB cables and a mounting bracket are available as additional options.

## Key Features

Feature	Advantages
Wide output power dynamic range	Dynamic range 85 dB, output power from -70 dBm to +15dBm in 0.25dB steps
USB & Ethernet control	USB HID and Ethernet (HTTP / Telnet) interfaces provide easy compatibility with a wide range of software setups and programming environments
Pulse modulation options	The SSG-6001RC can produce pulse modulated RF using internal or external modulating signal
Multiple sweep options	The SSG-6001RC can be set to sweep either power or frequency up, down, or bidirectionally.
Fine frequency resolution (3 Hz)	Allows precisely setting the desired signal, simplifying test setups

**Trademarks:** Windows is a registered trademark of Microsoft Corporation in the United States and other countries. Linux is a registered trademark of Linus Torvalds. Pentium is a registered trademark of Intel Corporation. Neither Mini-Circuits nor the Mini-Circuits SSG-series Synthesized Signal Generators are affiliated with or endorsed by the owners of the above referenced trademarks

Mini-Circuits and the Mini-Circuits logo are registered trademarks of Scientific Components Corporation.



## Electrical Specifications (General RF) at +25°C

Parameter	Test Conditions		Min.	Typ.	Max.	Units	
Output Frequency	-		1	-	6000	MHz	
Frequency Resolution <sup>1</sup>	1 - 3000 MHz		-	3	-	Hz	
	3000 - 6000 MHz		-	6	-	Hz	
Frequency accuracy	Using Internal Reference		-	1	-	ppm	
Settling time <sup>2, 4</sup>	-		-	2.0	-	msec	
Dwell time (nominal) <sup>3, 4</sup>	-		20	-	10,000	msec	
VSWR	1 - 3000 MHz		-	1.25	1.75	:1	
	3000 - 6000 MHz		-	1.55	2.3	:1	
Output power Max <sup>5</sup>	1 - 4500 MHz		+10	+15	-	dBm	
	4500 - 6000 MHz		Note 6	+11.5	-		
Output power Min <sup>5</sup>	1 - 6000 MHz		-	-70	-65	dBm	
Power resolution (nom.)	-		-	0.25	-	dB	
Dynamic range	-		-	85	-	dB	
Output power accuracy <sup>5, 6</sup>	1 - 2000 MHz	PWR <sub>out</sub> : -65 to +10 dBm	-	±0.15	±0.75	dB	
		2000 - 4500 MHz	PWR <sub>out</sub> : -65 to -45 dBm	-	±0.20		±1.30
	2000 - 4500 MHz	PWR <sub>out</sub> : -45 to -15 dBm	-	±0.15	±0.95		
		PWR <sub>out</sub> : -15 to +10 dBm	-	±0.15	±0.80		
		4500 - 6000 MHz	PWR <sub>out</sub> : -65 to -45 dBm	-	±0.30		±1.50
			PWR <sub>out</sub> : -45 to -15 dBm	-	±0.25		±1.25
PWR <sub>out</sub> : -15 to +10 dBm	-		±0.20	±1.15			
RF output level	@RF OFF		-	-120	-	dBm	
Harmonics and Sub-Harmonics <sup>5, 7</sup>	1 - 50 MHz	-65 to +10 dBm	-	-47	-30	dBc	
		50 - 3000 MHz	-65 to -55 dBm	-	-57		-28
	-55 to -40 dBm		-	-68	-35		
	-40 to -30 dBm		-	-77	-50		
	-30 to +5 dBm		-	-70	-35		
	+5 to +10 dBm		-	-53	-30		
	3000 - 6000 MHz	-65 to -50 dBm	-	-46	-		
		-50 to -45 dBm	-	-57	-23		
		-45 to 0 dBm	-	-63	-25		
		0 to +10 dBm	-	-90	-30		
Non-Harmonic Spurious	-		-	-85	-55	dBc	
Ethernet communication	Supports both HTTP and Telnet protocols over TCP/IP						

<sup>1</sup> Tested with external reference

<sup>2</sup> Settling time - transition time between 2 output states. During the transition, RF output is turned off to avoid transient outputs.

<sup>3</sup> Dwell time - duration of each signal point in a Sweep or Hop sequence set by user. Default is minimum dwell time.

<sup>4</sup> Generator response time is Dwell time + Settling Time.

<sup>5</sup> The generator is calibrated within typical power range, however performance is guaranteed only within power max/min limits.

<sup>6</sup> Max power over 4500 MHz derates linearly to +9 dBm at 6000 MHz. See max power graph on page 7 for illustration.

<sup>7</sup> Generator Sub-Harmonics(F0.5, F1.5, F2.5, etc...) are produced only in the 3000-6000 MHz range.

## Typical Phase Noise, SSB (dBc/Hz) at +25°C

Carrier Frequency (MHz)	Frequency Offset				
	100 Hz	1 kHz	10 kHz	100 kHz	1 MHz
10	-129	-141	-141	-142	-142
25	-122	-136	-140	-144	-145
46.875	-115	-131	-136	-144	-148
93.75	-110	-127	-130	-140	-149
187.5	-105	-120	-124	-135	-150
375	-99	-113	-118	-129	-150
750	-92	-107	-112	-122	-148
1000	-90	-106	-110	-116	-145
1500	-88	-103	-106	-116	-144
2000	-84	-100	-104	-111	-141
2500	-81	-98	-103	-105	-139
3000	-80	-96	-100	-103	-136
3500	-78	-95	-99	-104	-135
4000	-77	-93	-97	-105	-135
4500	-77	-92	-95	-107	-135
5000	-75	-91	-97	-99	-133
6000	-75	-90	-94	-98	-130

## Electrical Specifications (Pulse modulation modes) at +25°C

Parameter	Test Conditions	Min.	Typ.	Max.	Units
Pulse Width resolution	Nominal value	1	-	-	µSec
Pulse "off" time <sup>8</sup>	Measured at the 50% of pulse level	20	-	10e7	µSec
Pulse "on" time <sup>8</sup>	Measured at the 50% of pulse level	10	-	10e7	µSec
Duty cycle (in Free Run)	Pulse Width divided by Pulse Period	0.0001	-	99.9999	%
Rise / Fall time	Measured between 10% and 90% of pulse level	-	1.5 / 0.8	-	µsec
Pulse Width Accuracy <sup>9</sup>	Measured at 50% of pulse level	Internal pulse modulation	±4	-	µsec
		External pulse modulation	±6	-	
External pulse mod. input threshold	External pulse modulation	-	-	2.4	V
Trigger response delay	Trigger edge to 50% of pulse level	-	10	-	µSec
Pulse Power ratio	@PWR <sub>OUT</sub> =+10dBm, FREQ <sub>OUT</sub> =10 MHz	-	70	-	dB
Pulse Power ratio	@PWR <sub>OUT</sub> =+10dBm, FREQ <sub>OUT</sub> =6000 MHz	-	65	-	

<sup>8</sup> Total pulse period max=10 Sec

<sup>9</sup> With long pulse widths, typ. accuracy may increase up to 3% of pulse width.

## Electrical Specifications at +25°C (Reference, Trigger & DC power)

Parameter	Test Conditions	Min.	Typ.	Max.	Units	
Aging	Using Internal Reference	-	2	-	ppm/yr	
Reference In	Frequency	-	10	-	MHz	
	Power	-	-3.5	+7.5	dBm	
	Phase Noise	@ 10kHz Offset	-	-145	-	dBc/Hz
Reference Out	Frequency	-	10	-	MHz	
	Freq. Accuracy	Using Internal Reference	-	±1	-	ppm
	Power	-	-	+5.5	-	dBm
Trigger Out, Low <sup>10</sup>	-	0	-	0.4	V	
Trigger Out, High <sup>10</sup>	-	2.4	-	3.3		
Trigger In, Low <sup>10</sup>	-	0	-	0.4		
Trigger In, High <sup>10</sup>	-	2.4	-	5		
Supply Voltage <sup>11</sup>	-	11.4	12	12.6	V <sub>DC</sub>	
Supply Current <sup>11</sup>	-	-	0.85	1.3	A	
USB current <sup>11</sup>	SSG-6001RC does not draw power from the USB bus, only from the DC power adapter				mA	

<sup>10</sup> Supports TTL, LVTTTL and CMOS triggers

<sup>11</sup> Power On Sequence: Connect the 12V power, followed by the USB or Ethernet control before turning on the Generator.

## Absolute Maximum Ratings

Operating Temperature	0°C to +50°C
Storage Temperature	-20°C to +60°C
Power in @ Reference In	+10 dBm
Reverse Power(DC) @ Reference Out	8 V <sub>DC</sub>
Reverse Power(DC) @ RF Out	8 V <sub>DC</sub>
Voltage input to Trigger ports	-0.3V <sub>DC</sub> to +3.5V <sub>DC</sub>

Permanent damage may occur if any of these limits are exceeded. Operating in the range between operating power limits and absolute maximum ratings for extended periods of time may result in reduced life and reliability.

## Connections

RF Output	(N Type-Female)
Ref. In	(BNC-Female)
Ref. Out	(BNC-Female)
Trigger In	(BNC-Female)
Trigger Out	(BNC-Female)
Power In	(2.1 mm DC socket)
USB Port	(USB type B female)
Network (Ethernet/LAN)	(RJ45 socket)

## Typical Performance Curves\*

\*at +25°C unless noted otherwise

Harmonics & Sub-Harmonics Levels Vs. Output Frequency PWR=-65dBm

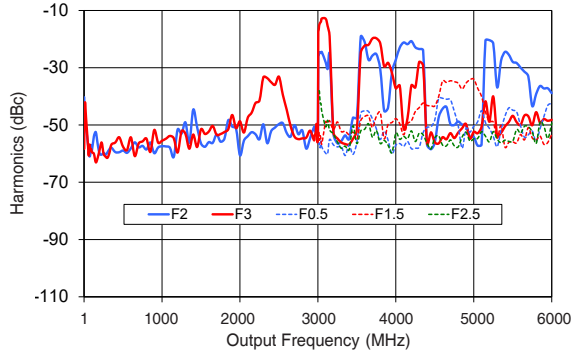

Harmonics & Sub-Harmonics Levels Vs. Output Frequency PWR=-50dBm

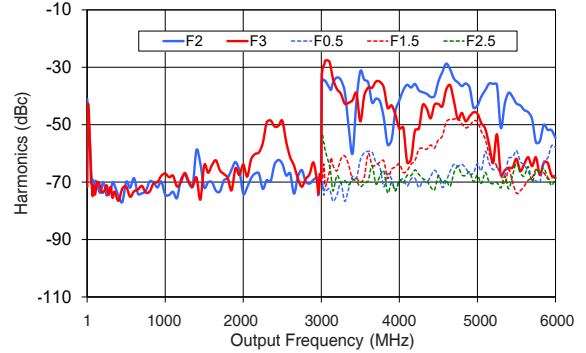

Harmonics & Sub-Harmonics Levels Vs. Output Frequency PWR=-40dBm

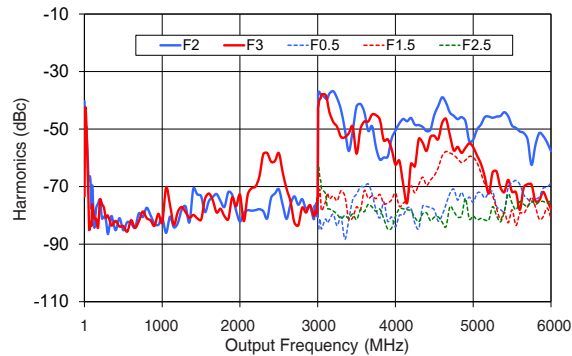

Harmonics & Sub-Harmonics Levels Vs. Output Frequency PWR=-20dBm

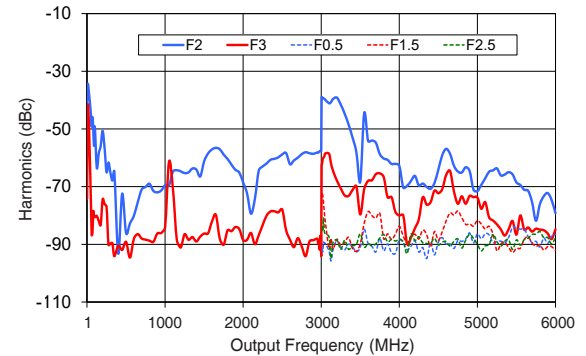

Harmonics & Sub-Harmonics Levels Vs. Output Frequency PWR=0dBm

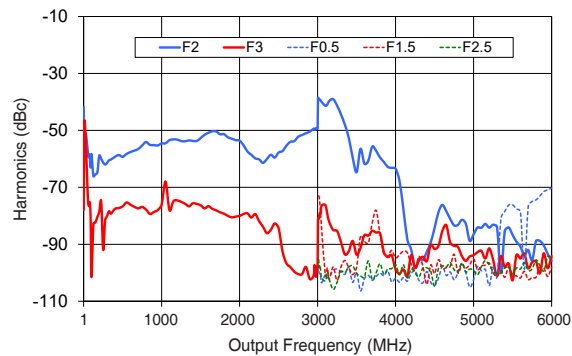

Harmonics & Sub-Harmonics Levels Vs. Output Frequency PWR=+10dBm

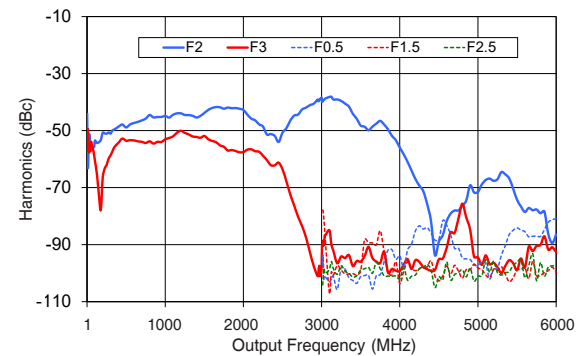

## Typical Performance Curves\* (continued)

\*at +25°C unless noted otherwise

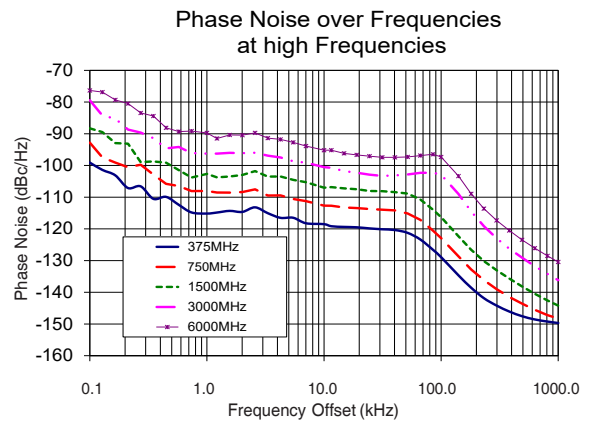
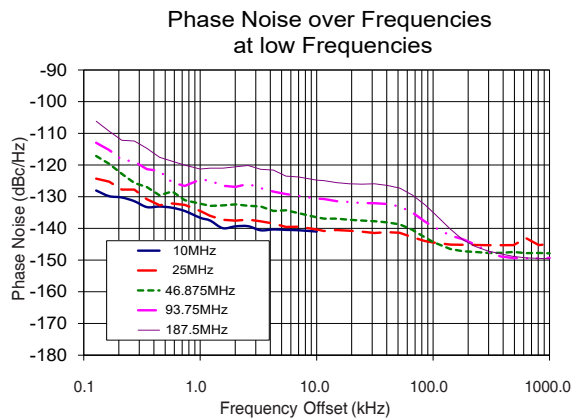
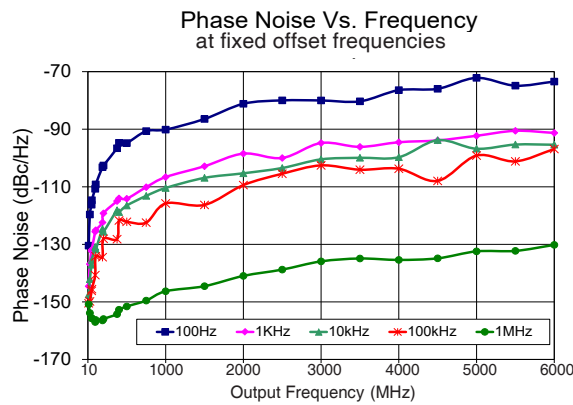
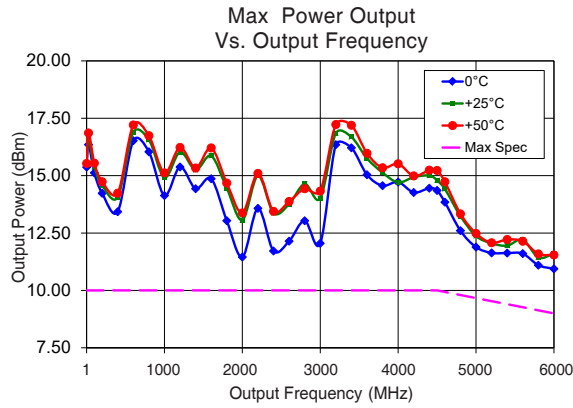

## Typical Performance Curves\* (continued)

\*at +25°C unless noted otherwise

Spurious @Negative Offset & Low Freq Output Vs Frequency Offset

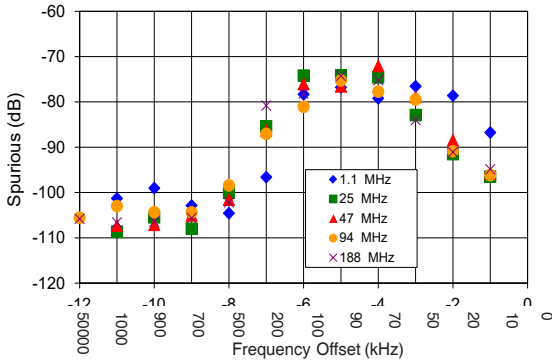

Spurious @Positive Offset & Low Freq Output Vs Frequency Offset

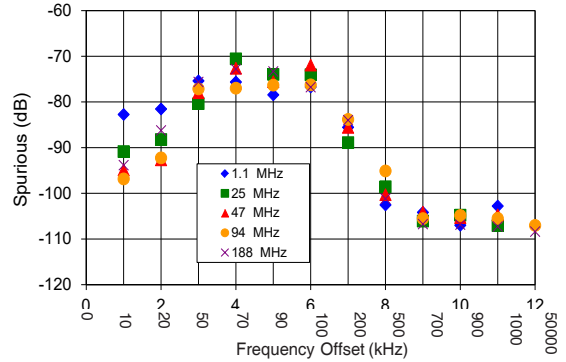

Spurious @Negative Offset & High Freq Output Vs Frequency Offset

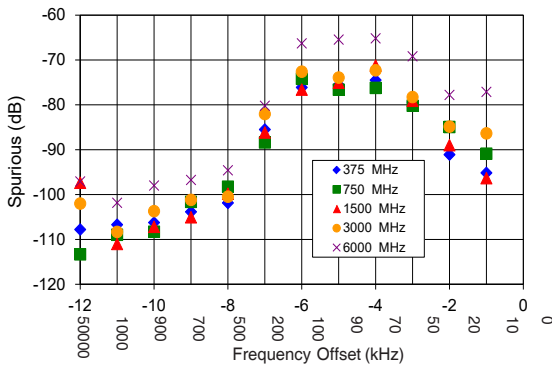

Spurious @Positive Offset & High Freq Output Vs Frequency Offset

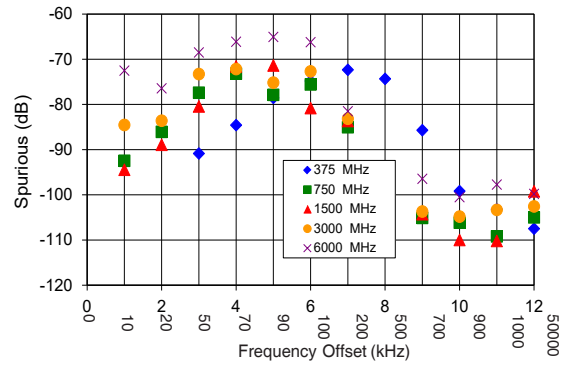

Power Accuracy Vs. Output Frequency

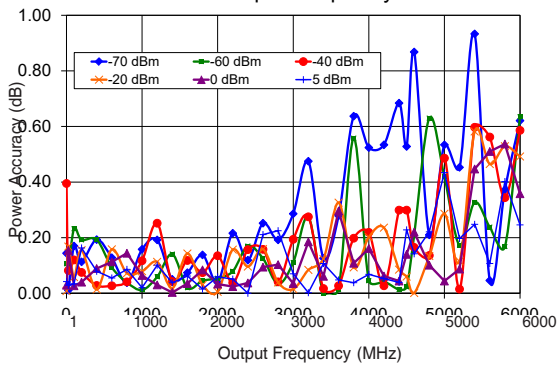

Power Accuracy Vs. Output Power

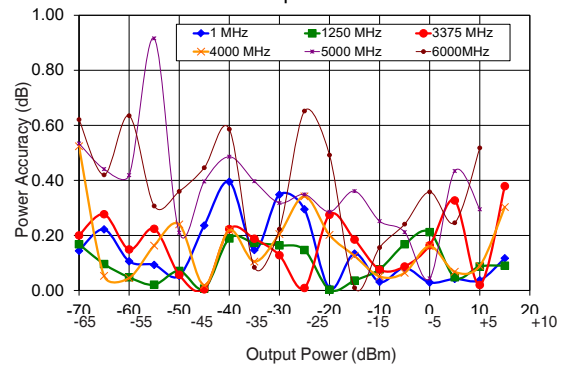

## Outline Drawing LV1913

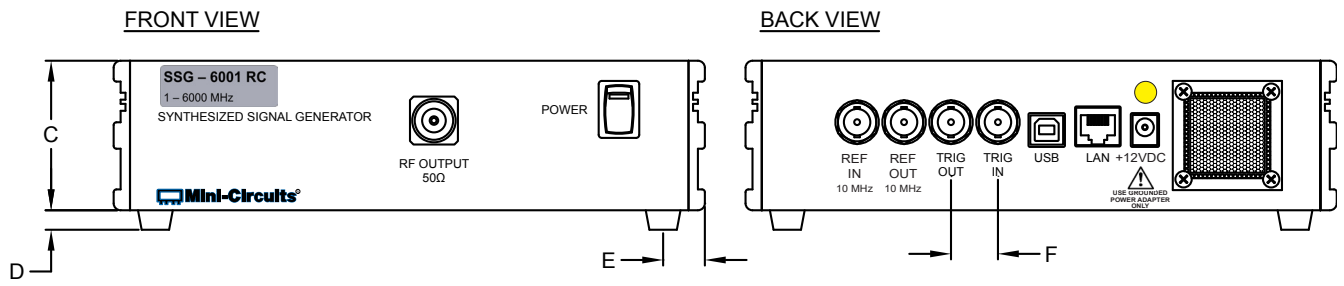
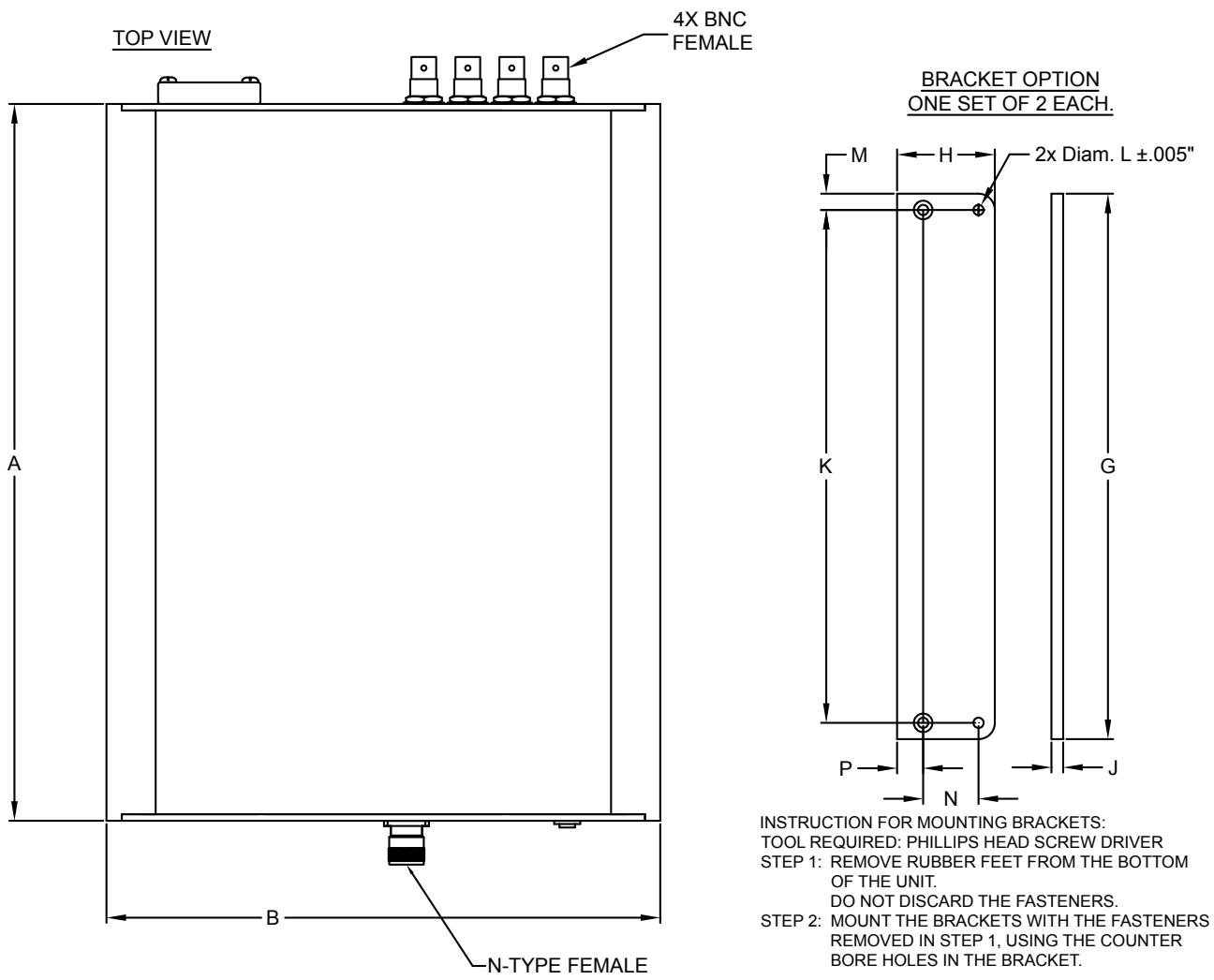

### Outline Dimensions (inch/mm)

A	B	C	D	E	F	G	H	J	K	L	M	N	P	WT. GRAMS
11.00	8.50	2.15	0.28	0.60	0.68	8.37	1.50	0.18	7.870	0.158	0.25	0.850	0.40	3200
279.4	215.9	54.6	7.1	15.2	17.27	212.6	38.1	4.6	199.9	4.0	6.35	21.6	10.2	



## Software & Documentation Download:

- Mini-Circuits' full software and support package including user guide, Windows GUI, DLL files, programming manual and examples can be downloaded free of charge from <https://www.minicircuits.com/softwaredownload/sg.html>
- Please contact [testsolutions@minicircuits.com](mailto:testsolutions@minicircuits.com) for support

## Minimum System Requirements

Parameter	Requirements	
Interface	USB HID or HTTP Get/Post or Telnet protocols	
System requirements	GUI:	Windows 32 & 64 bit systems from Windows 98 up to Windows 10
	USB API (ActiveX & .Net)	Windows 32 & 64 bit systems with ActiveX or .Net support from Windows 98 up to Windows 10
	USB direct programming support	Linux, Windows systems from Windows 98 up to Windows 10
	HTTP or Telnet	Any computer with a network port and Ethernet-TCP/IP (HTTP or Telnet protocols) support
Hardware	Pentium® II or better	

## Graphical User Interface (GUI) for Windows

### Key Features:

- Set frequency and power
- Configure generator state at power-up
- Track operating time since last calibration and set reminder for calibration.
- Freq. & Power sweeps, up, down and bi-directional
- Pulse modulation signals
- Synchronize frequency and power sweeps from up to 4 generators.
- USB, HTTP or Telnet control of SSG
- Setting Ethernet configuration

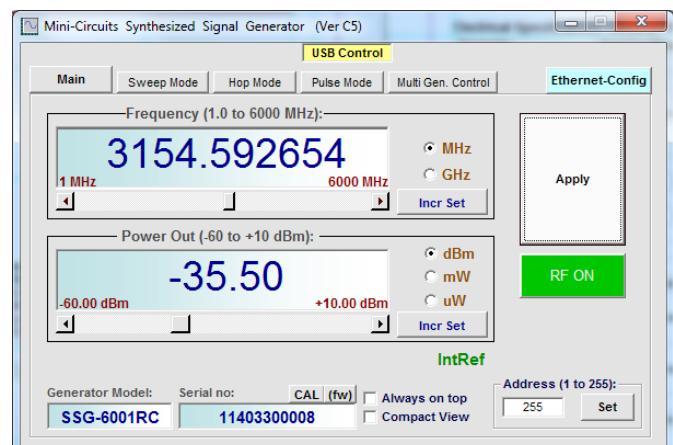

## Application Programming Interface (API)

### Windows Support:



- API DLL files exposing the full power sensor functionality
  - ActiveX COM DLL file for creation of 32-bit programs
  - .Net library DLL file for creation of 32 / 64-bit programs
- HTTP Get/Post and Telnet protocols use SCPI commands to provide full control.
- Supported by most common programming environments (refer to application note [AN-49-001](#) for summary of tested environments)





### Linux Support:

- Full power sensor control in a Linux environment is achieved by way of USB interrupt commands.

Ordering, Pricing & Availability Information see our web site

Model	Description
SSG-6001RC	USB/Ethernet Synthesized Signal Generator

Included Accessories	Part No.	Description
	AC/DC-12-3W1	AC/DC 12V <sub>DC</sub> Grounded Power Adaptor. Operating temperature: 0°C to +40°C, I <sub>Max</sub> =5A
	CBL-3W1-XX	AC Power Cord ( <i>Select one power cord from below with each Signal Generator</i> )
	USB-CBL-AB-3+	2.7 ft (0.8 m) USB Cable: USB type A(Male) to USB type B(Male)
	CBL-RJ45-MM-5+	5 ft. network cable: RJ45(Male) to RJ45(Male) Cat 5E cable.

AC Power Cords <sup>12</sup>	Part No.	Description
	CBL-3W1-US	Power Cord for United States
	CBL-3W1-EU	Power Cord for Europe
	CBL-3W1-UK	Power Cord for United Kingdom
	CBL-3W1-AU	Power Cord for Australia and China
	CBL-3W1-IL	Power Cord for Israel

<sup>12</sup> Power cords for other countries are also available, if you need a power cord for a country not listed in the table please contact [testsolutions@minicircuits.com](mailto:testsolutions@minicircuits.com) for support. .

Optional Accessories	Description
USB-CBL-AB-3+ (spare)	2.7 ft. (0.8 m) USB cable
USB-CBL-AB-7+	6.8 ft. (2.1 m) USB Cable
USB-CBL-AB-11+	11 ft. (3.4 m) USB Cable
BKT-280-06+	Bracket (One set of 2 each)

Calibration	Description
CALSSG-6001RC	Calibration Service

[Click Here](#)

### Additional Notes

- A. Performance and quality attributes and conditions not expressly stated in this specification document are intended to be excluded and do not form a part of this specification document.
- B. Electrical specifications and performance data contained in this specification document are based on Mini-Circuit's applicable established test performance criteria and measurement instructions.
- C. The parts covered by this specification document are subject to Mini-Circuits standard limited warranty and terms and conditions (collectively, "Standard Terms"); Purchasers of this part are entitled to the rights and benefits contained therein. For a full statement of the Standard Terms and the exclusive rights and remedies thereunder, please visit Mini-Circuits' website at [www.minicircuits.com/MCLStore/terms.jsp](http://www.minicircuits.com/MCLStore/terms.jsp)

