

# High Power Bi-Directional Coupler

## SYBD-16-272HP+

50Ω 16dB Coupling DC Pass 1750 to 2700 MHz

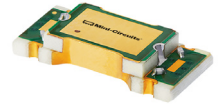

Generic photo used for illustration purposes only

CASE STYLE: JB1233

**+RoHS Compliant**

The +Suffix identifies RoHS Compliance. See our web site for RoHS Compliance methodologies and qualifications

### Maximum Ratings

Operating Temperature	-55°C to 100°C
Storage Temperature	-55°C to 100°C
DC Current	2A

Permanent damage may occur if any of these limits are exceeded.

### Pin Connections

INPUT	1
OUTPUT	2
COUPLED (forward)	4
COUPLED (reverse)	3
GROUND	5

### Outline Drawing

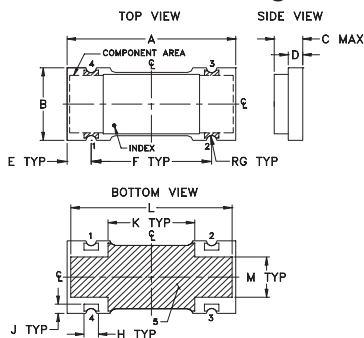

### PCB Land Pattern

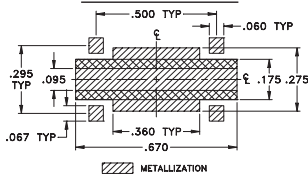

Suggested Layout,  
Tolerance to be within ±0.02

### Outline Dimensions (inch/mm)

A	B	C	D	E	F	G
.70	.32	.13	.060	.100	.500	.022
17.78	8.13	3.30	1.52	2.54	12.70	0.56
H	J	K	L	M		wt
.060	.040	.360	.670	.175		grams
1.52	1.02	9.14	17.02	4.45		0.68

### Demo Board MCL P/N: TB-398 Suggested PCB Layout (PL-260)

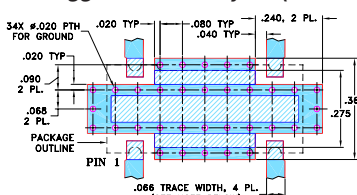

- NOTES: 1. TRACE WIDTH IS SHOWN FOR ROGERS RO4350B WITH DIELECTRIC THICKNESS .030" ± .002"; COPPER: 1/2 OZ. EACH SIDE. FOR OTHER MATERIALS TRACE WIDTH MAY NEED TO BE MODIFIED.  
2. BOTTOM SIDE OF THE PCB IS CONTINUOUS GROUND PLANE.  
3. DENOTES PCB COPPER LAYOUT WITH SMOBC (SOLDER MASK OVER BARE COPPER)  
4. DENOTES COPPER LAND PATTERN FREE OF SOLDER MASK

### Notes

- A. Performance and quality attributes and conditions not expressly stated in this specification document are intended to be excluded and do not form a part of this specification document.  
B. Electrical specifications and performance data contained in this specification document are based on Mini-Circuit's applicable established test performance criteria and measurement instructions.  
C. The parts covered by this specification document are subject to Mini-Circuit's standard limited warranty and terms and conditions (collectively, "Standard Terms"); Purchasers of this part are entitled to the rights and benefits contained therein. For a full statement of the Standard Terms and the exclusive rights and remedies thereunder, please visit Mini-Circuit's website at [www.minicircuits.com/WCLStore/terms.jsp](http://www.minicircuits.com/WCLStore/terms.jsp)

### Features

- high power handling, 25 watts max.
- low mainline loss, 0.2 dB typ.
- excellent VSWR, 1.2:1 typ.
- excellent directivity, 30 dB typ.
- wideband frequency, 1750 to 2700 MHz

### Applications

- PCS
- ISM
- cable TV delay
- defense communications
- federal communications

### Bi-Directional Coupler Electrical Specifications

FREQ. (MHz)	COUPLING (dB)		MAINLINE LOSS <sup>1</sup> (dB)		DIRECTIVITY (dB)		VSWR (:1)	POWER INPUT (W)
	Nom.	Flatness	Typ.	Max.	Typ.	Min.	Typ.	Max.
$f_c - f_u$								
1750-2700			0.2	0.5	30	17	1.20	
1750-1950	18.0±0.7	±0.5	0.13	0.4	30	18	1.10	25
1950-2300	17.1±0.8	±0.7	0.18	0.45	30	18	1.15	25
2300-2700	16.1±0.8	±0.7	0.20	0.50	30	17	1.20	25

1. Mainline loss includes theoretical power loss at coupled port.

### Typical Performance Data

Frequency (MHz)	Mainline Loss (dB)	Coupling (dB)		Directivity (dB)		Return Loss (dB)			
		In-Out	In-Cpl Fwd	Out-Cpl Rev	Out-Cpl Fwd	In-Cpl Rev	In	Out	Cpl Fwd
1750.00	0.14	18.58	18.59	30.54	34.47	38.33	37.11	43.29	43.72
1850.00	0.15	18.15	18.19	33.65	39.80	42.84	44.96	46.54	45.18
1950.00	0.15	17.78	17.81	33.89	40.07	38.58	39.14	39.48	39.16
2150.00	0.18	17.13	17.16	33.20	34.51	31.58	31.55	33.58	33.11
2300.00	0.19	16.70	16.72	33.54	33.29	30.01	30.26	32.24	32.59
2350.00	0.20	16.57	16.59	33.69	32.65	29.85	29.82	32.08	32.43
2400.00	0.20	16.43	16.45	34.28	32.96	30.16	30.17	32.27	33.03
2550.00	0.21	16.07	16.08	33.84	30.94	32.50	31.70	34.27	35.32
2650.00	0.20	15.84	15.84	32.36	29.14	35.95	34.48	36.17	38.93
2700.00	0.21	15.73	15.74	31.11	28.33	38.29	36.15	36.76	40.44

SYBD-16-272HP+  
MAINLINE LOSS

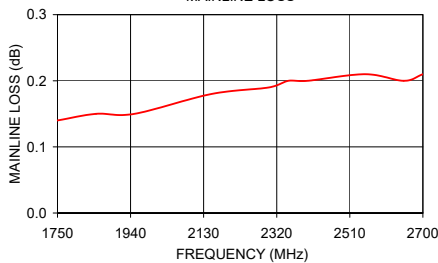

SYBD-16-272HP+  
COUPLING & DIRECTIVITY

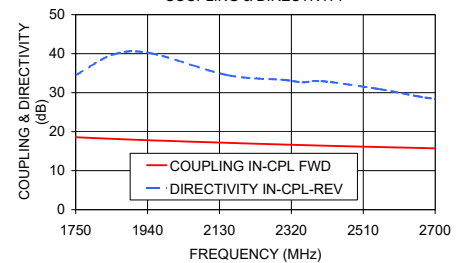

SYBD-16-272HP+  
RETURN LOSS

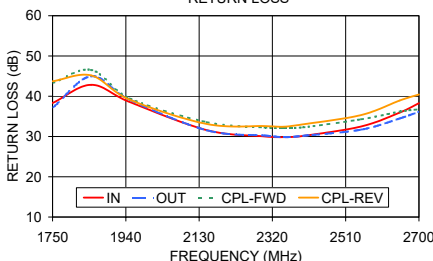

### Electrical Schematic

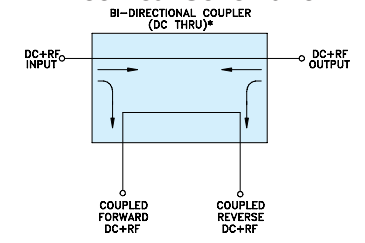

\* ELECTRICAL SCHEMATIC IS FOR BI-DIRECTIONAL COUPLER WITHOUT INTERNAL TRANSFORMERS AND RESISTORS.



[www.minicircuits.com](http://www.minicircuits.com) P.O. Box 350166, Brooklyn, NY 11235-0003 (718) 934-4500 sales@minicircuits.com

REV. B  
M151107  
ED-12713/2  
SYBD-16-272HP+  
WZ/CP/AM  
200811