



THE BIG DEAL

- Wideband, 1500 to 6700 MHz
- Balanced transmission line
- Low insertion loss 0.8 dB at 4 GHz
- Flat insertion loss, 0.6 dB typ.
- Good input return loss, 15 dB typ.
- Low phase and amplitude unbalance, 6°, 0.8 dB at 4 GHz
- Aqueous washable

APPLICATIONS

- PCS
- Wideband push-pull amplifiers
- Cellular

PRODUCT OVERVIEW

Mini-Circuits' TCM2-672AX+ is a surface-mount transmission line core and wire transformer covering a very wide frequency range from 1500 to 6700 MHz. The transformer provides low insertion loss with excellent flatness over its entire frequency range. It achieves low phase and amplitude unbalance and excellent input return loss performance. Featuring core and wire construction on a 6-lead plastic base with tin over nickel termination finish, the unit measures 0.16 x 0.15 x 0.16", accommodating dense circuit board layouts. It also incorporates Mini-Circuits' Top Hat® feature for faster, more accurate pick-and-place assembly and easy visual inspection.



CASE STYLE: DB1627

Generic photo used for illustration purposes only

+RoHS Compliant

The +Suffix identifies RoHS Compliance. See our web site for RoHS Compliance methodologies and qualifications

KEY FEATURES

Feature	Advantages
Wide band, 1500 to 6700 MHz	Very wide frequency range covers bandwidth requirements for many broadband applications.
Low insertion loss, 0.8 dB at 4 GHz	TCM2-672AX+ provides excellent signal transmission from input to output with consistent performance across its entire frequency range.
Good input return loss, 15 dB typ.	Provides good matching with minimal signal reflection.
Small footprint (0.16 x 0.15 x 0.16")	Accommodates tight space requirements for dense PCB layouts.
Top Hat® feature	Improves speed and accuracy of pick and place assembly and provides clear device marking for visual inspection.



ELECTRICAL SPECIFICATIONS AT 25°C

Parameter	Frequency (MHz)	Min.	Typ.	Max.	Units
Impedance Ratio (secondary/primary)		2			
Frequency Range		1500		6700	MHz
Insertion Loss ¹	1500-4000	-	0.8	1.5	dB
	4000-6700	-	2.1	3.2	
Amplitude Unbalance	1500-4000	-	0.8	-	dB
	4000-6700	-	1.0	-	
Phase Unbalance	1500-4000	-	6	-	Degree
	4000-6700	-	9	-	
Return Loss	1500-6700	-	15	-	dB

1. Referenced to nominal loss of 0.2 dB typ.

MAXIMUM RATINGS

Parameter	Ratings
Operating temperature	-40°C to 85°C
Storage temperature	-55°C to 100°C
RF Power	0.4 W
DC Current	30 mA

CONFIGURATION G

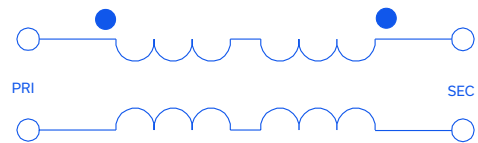



PAD CONNECTIONS

Function	Pad Number
PRIMARY DOT	3
PRIMARY (GND)	2
SECONDARY DOT	4
SECONDARY	5
NOT USED	1,6

OUTLINE DRAWING

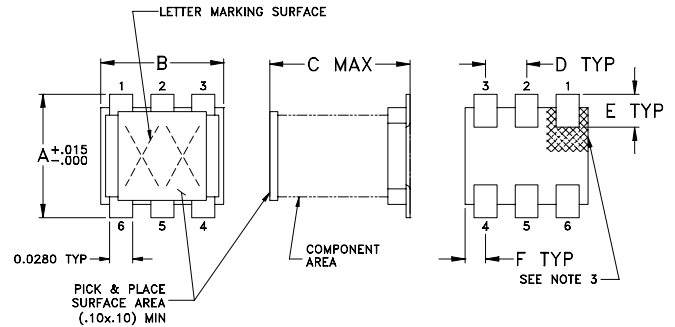

PRODUCT MARKING: YL

**DEMOBOARD MCL P/N: TB-TCM-672AX+
SUGGESTED PCB LAYOUT (PL-422)**

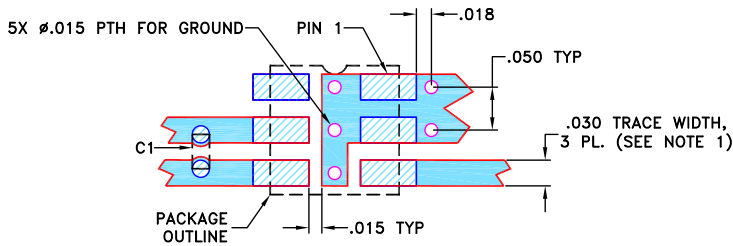

COMPONENT	SIZE
C1	0402

NOTES:

- TRACE WIDTH PARAMETERS ARE SHOWN FOR ROGERS RO4350B WITH DIELECTRIC THICKNESS $.0133 \pm .001$ ". COPPER: 1/2 OZ. EACH SIDE. FOR OTHER MATERIALS TRACE WIDTH MAY NEED TO BE MODIFIED.
 - CHIP COMPONENT FOOT PRINTS SHOWN FOR REFERENCE. FOR COMPONENT VALUES REFER TO TB-742+.
 - BOTTOM SIDE OF THE PCB IS CONTINUOUS GROUND PLANE.
- DENOTES PCB COPPER LAYOUT WITH SMOBC (SOLDER MASK OVER BARE COPPER).
- DENOTES COPPER LAND PATTERN FREE OF SOLDER MASK.

PCB Land Pattern

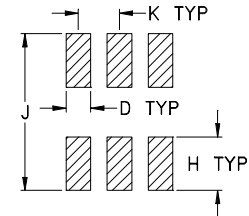

Suggested Layout,
Tolerance to be within $\pm .002$

OUTLINE DIMENSIONS (Inches mm)

A	B	C	D	E	F
.160	.150	.160	.050	.040	.025
4.06	3.81	4.06	1.27	1.02	0.64
G	H	J	K		wt
.028	.065	.190	.030		grams
0.71	1.65	4.83	0.76		0.15



TYPICAL PERFORMANCE DATA

Frequency (MHz)	Insertion Loss (dB)	Return Loss (dB)	Amplitude Unbalance (dB)	Phase Unbalance (deg)
1500	0.48	15.53	0.65	3.09
2200	0.44	26.48	0.36	6.70
2500	0.52	19.67	0.11	7.81
3100	0.75	13.84	0.23	6.93
3400	0.76	13.79	0.23	6.76
4000	0.79	15.56	0.53	4.59
4600	0.96	14.00	0.26	0.16
5200	1.11	13.17	0.13	3.39
6100	1.56	12.13	0.46	6.60
6700	2.05	10.36	0.64	4.57

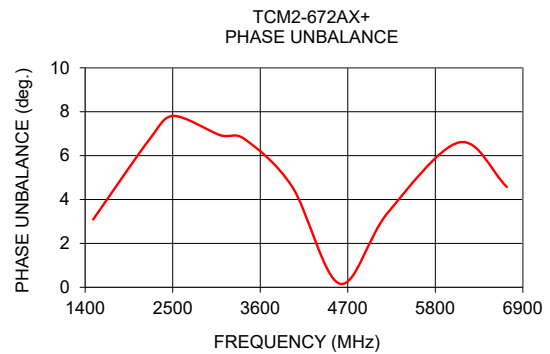
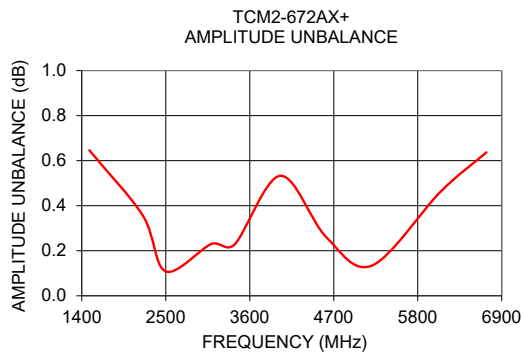
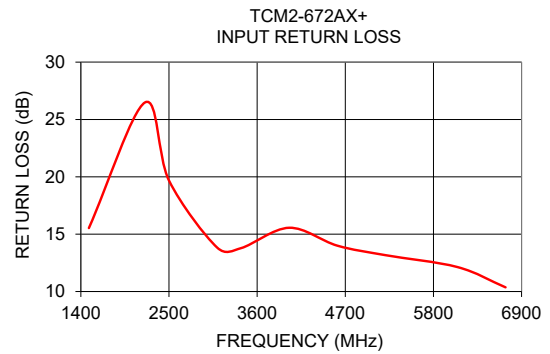
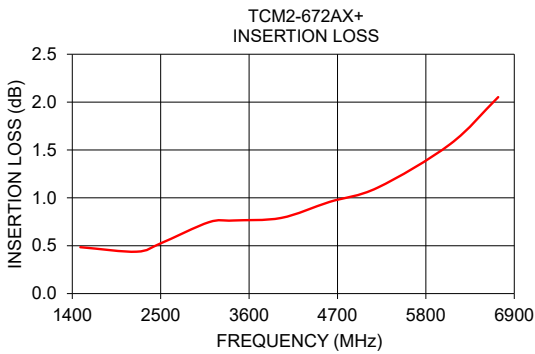

- NOTES**
- A. Performance and quality attributes and conditions not expressly stated in this specification document are intended to be excluded and do not form a part of this specification document.
 - B. Electrical specifications and performance data contained in this specification document are based on Mini-Circuit's applicable established test performance criteria and measurement instructions.
 - C. The parts covered by this specification document are subject to Mini-Circuits standard limited warranty and terms and conditions (collectively, "Standard Terms"); Purchasers of this part are entitled to the rights and benefits contained therein. For a full statement of the standard. Terms and the exclusive rights and remedies thereunder, please visit Mini-Circuits' website at www.minicircuits.com/MCLStore/terms.jsp