



Mini-Circuits

SURFACE MOUNT 

# Power Splitter/Combiner TCP-2-25X+

2 Way-0° 50Ω 200 to 2500 MHz

## FEATURES

- Low insertion, 0.8 dB typ.
- Excellent amplitude unbalance, 0.2 dB typ.
- Very good phase unbalance, 1.2 deg. typ.
- External resistor & capacitor required
- Aqueous washable
- Leads for excellent solderability
- Low cost



Generic photo used for illustration purposes only

CASE STYLE: DB1627

### +RoHS Compliant

The +Suffix identifies RoHS Compliance. See our web site for RoHS Compliance methodologies and qualifications

## APPLICATIONS

- Cellular
- PCN
- GPS

## ELECTRICAL SPECIFICATIONS AT 25°C

Parameter	Frequency (MHz)	Min.	Typ.	Max.	Unit
Frequency Range		200		2500	MHz
Insertion Loss, above 3.0 dB	200 - 2500	—	0.8	1.3	dB
Isolation	200 - 2500	10	18	—	dB
Phase Unbalance	200 - 2500	—	—	6.0	Degree
Amplitude Unbalance	200 - 2500	—	—	0.8	dB

## MAXIMUM RATINGS

Parameter	Ratings
Operating temperature	-40°C to 85°C
Storage temperature	-55°C to 100°C
RF Power Input (as splitter)	0.5 W max.

Permanent damage may occur if any of these limits are exceeded.

## FUNCTIONAL SCHEMATIC

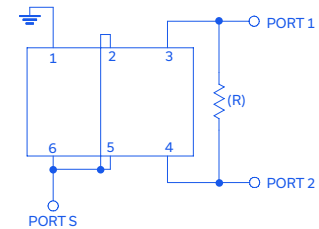

REV. B  
ECO-012587  
TCP-2-25X+  
DY/TD/CP/AM  
220328





# Power Splitter/Combiner **TCP-2-25X+**

## PIN CONNECTIONS

SUM PORT	2,5,6
PORT 1	3
PORT 2	4
GROUND	1
EXT. RESISTOR 475Ω	3,4

**PRODUCT MARKING:** N/A

**DEMO BOARD MCL P/N:** TB-86  
**SUGGESTED PCB LAYOUT (PL-008)**

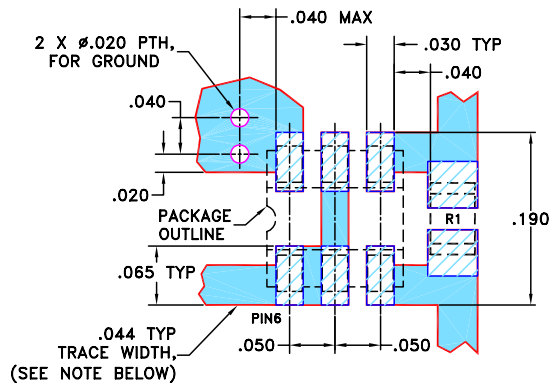

RESISTOR R1: 475 ± 1% Ohm, 0805 SIZE

- NOTES: 1. TRACE WIDTH IS SHOWN FOR ROGERS R04350B WITH DIELECTRIC THICKNESS 0.020" ± 0.0015"; COPPER: 1/2 OZ. EACH SIDE. FOR OTHER MATERIALS TRACE WIDTH MAY NEED TO BE MODIFIED.
2. BOTTOM SIDE OF THE PCB IS CONTINUOUS GROUND PLANE.

- DENOTES PCB COPPER LAYOUT WITH SMOBC (SOLDER MASK OVER BARE COPPER)
- DENOTES COPPER LAND PATTERN FREE OF SOLDER MASK

## OUTLINE DRAWING

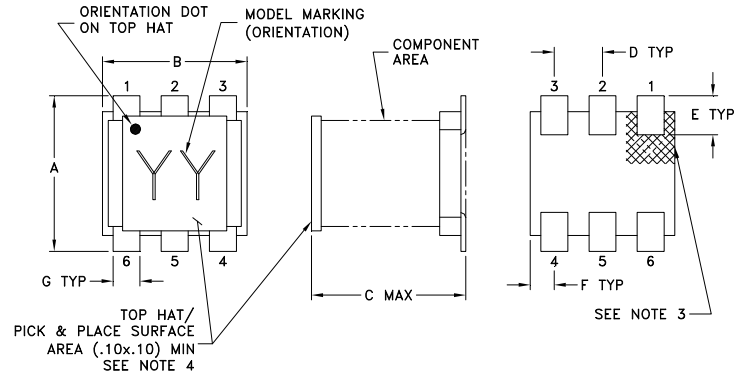

## PCB Land Pattern

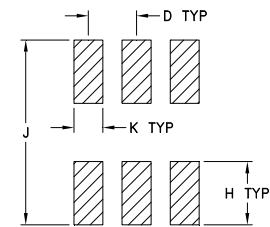

SUGGESTED LAYOUT  
 TOLERANCE TO BE WITHIN ±.002

## OUTLINE DIMENSIONS (Inches/mm)

A	B	C	D	E	F
.160	.150	.160	.050	.040	.025
4.06	3.81	4.06	1.27	1.02	0.64
G	H	J	K		wt
.028	.065	.190	.030		grams
0.71	1.65	4.83	0.76		0.15

## TAPE & REEL INFORMATION: F47



# Power Splitter/Combiner TCP-2-25X+

## TYPICAL PERFORMANCE DATA AT 25°C

Frequency (MHz)	Total Loss <sup>1</sup> (dB)		Amplitude Unbalance (dB)	Isolation (dB)	Phase Unbalance (deg.)	VSWR (:1)		
	S-1	S-2				S	1	2
200.00	3.59	3.60	0.01	17.18	0.16	1.96	1.56	1.56
300.00	3.59	3.62	0.03	18.14	0.19	1.96	1.59	1.60
450.00	3.61	3.65	0.04	19.32	0.24	1.95	1.63	1.64
550.00	3.62	3.67	0.05	20.10	0.25	1.95	1.66	1.67
650.00	3.62	3.69	0.07	20.96	0.31	1.94	1.68	1.69
850.00	3.62	3.72	0.10	23.08	0.32	1.92	1.74	1.75
950.00	3.63	3.74	0.11	24.37	0.35	1.92	1.76	1.77
1050.00	3.63	3.76	0.13	25.89	0.38	1.91	1.79	1.80
1150.00	3.63	3.78	0.15	27.69	0.44	1.89	1.82	1.83
1250.00	3.63	3.79	0.16	30.01	0.48	1.88	1.84	1.86
1400.00	3.64	3.82	0.18	35.48	0.56	1.85	1.88	1.90
1800.00	3.64	3.91	0.27	31.95	0.78	1.79	1.98	2.03
2000.00	3.66	3.97	0.31	26.83	0.86	1.75	2.03	2.09
2200.00	3.67	4.04	0.37	23.56	1.14	1.73	2.08	2.16
2500.00	3.70	4.13	0.43	20.27	1.32	1.71	2.15	2.27

1. Total Loss = Insertion Loss + 3dB splitter loss.

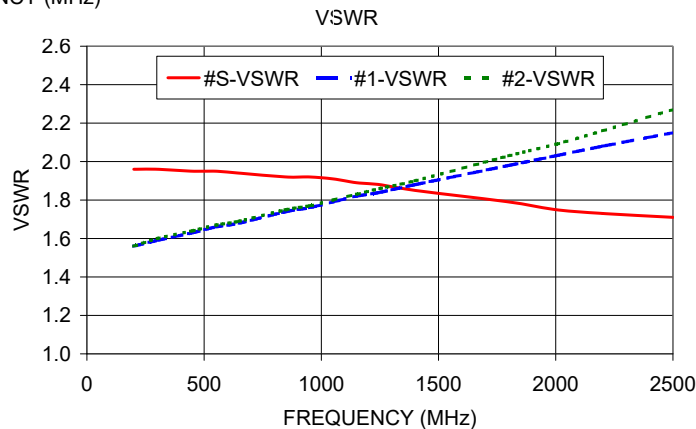
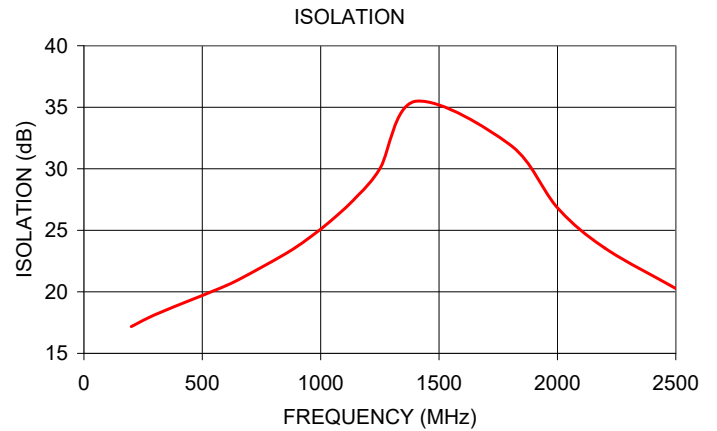
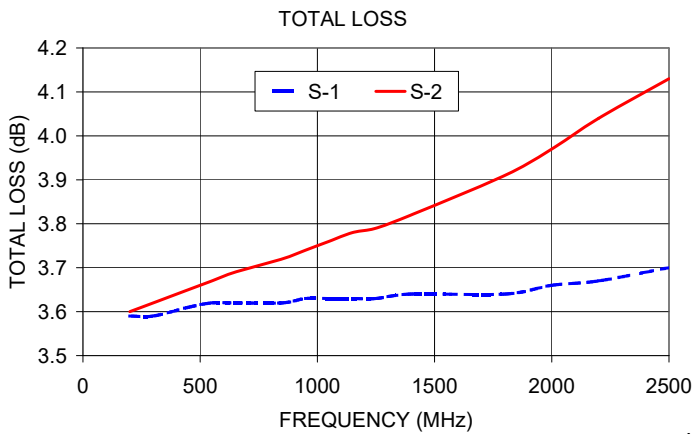

### NOTES

- A. Performance and quality attributes and conditions not expressly stated in this specification document are intended to be excluded and do not form a part of this specification document.
- B. Electrical specifications and performance data contained in this specification document are based on Mini-Circuit's applicable established test performance criteria and measurement instructions.
- C. The parts covered by this specification document are subject to Mini-Circuits standard limited warranty and terms and conditions (collectively, "Standard Terms"); Purchasers of this part are entitled to the rights and benefits contained therein. For a full statement of the standard. Terms and the exclusive rights and remedies thereunder, please visit Mini-Circuits' website at [www.minicircuits.com/terms/viewterm.html](http://www.minicircuits.com/terms/viewterm.html)