



COAXIAL

Limiter

VLM-73-1W-S+

50Ω Broadband 30 to 7000 MHz +12 to +30 dBm SMA Female to SMA Male

KEY FEATURES

- Wideband, 30 to 7000 MHz
- Low insertion loss 0.4 dB typ.
- Fast recovery time, 5 nsec typ.
- Excellent VSWR, 1.05:1 typ.
- Low leakage power, +11.5 dBm typ.



Generic photo used for illustration purposes only

APPLICATIONS

- Protects low noise amplifiers and other devices from ESD or input power damage
- Military, hi-rel applications

PRODUCT OVERVIEW

The VLM-73-1W-S+ reacts almost instantaneously to protect sensitive devices from power surges and other unwanted signals at the device input. For inputs > +12 dBm, the output power remains about +11.5 dBm, whereas lower-level input losses are only 0.4 dB typ. These units are housed in a patented, rugged unibody enclosure (1.43" x 0.410") specifically designed to function in tough environments such as manufacturing sites, train tunnels, weapon systems, or anywhere sensitive components, such as low noise amplifiers, need protection.

ELECTRICAL SPECIFICATIONS AT +25°C

Parameter	Condition	Min.	Typ.	Max.	Units
Frequency Range		30	-	7000	MHz
Insertion Loss in Linear Range	<+2 dBm Input	-	0.4	1.3	dB
VSWR	<+2 dBm Input	-	1.05	1.7	:1
Input Power Limiting Range		+12	-	+30	dBm
Output Power	In limiting range	-	+11.5	-	dBm
Recovery Time	1 watt pulse 50 μsec pw 1kHz duty cycle recovery to within 90% of final value.	-	5	-	nsec
Response Time	-30 to +30 dBm input 50 μsec, BW 1 kHz duty cycle	-	7	-	nsec
Limiting Δ Output/1dB Δ Input	Input Power Range (dBm)				
	12 to 20	-	0.3	-	dB/dB
	20 to 25		0.5		
	25 to 30		0.6		

ABSOLUTE MAXIMUM RATINGS¹

Operating Temperature	-55°C to 100°C
Storage Temperature	-55°C to 100°C
Input Power ²	1.5 W CW*

1. Permanent damage may occur if any of these limits are exceeded.

2. At 25°C. Pulse power can be higher, depending on pulsewidth and duty cycle.





COAXIAL

Limiter

VLM-73-1W-S+

50Ω Broadband 30 to 7000 MHz +12 to +30 dBm SMA Female to SMA Male

TYPICAL PERFORMANCE DATA

Freq. (MHz)	I. Loss in Linear Range (dB)	VSWR in Linear Range (:1)	Power Output (dBm)				Δ Output 1dB Δ Input		
			+12dBm Input	+20dBm Input	+25 dBm Input	+30dBm Input	+12 to +20dBm Input	+20 to +25 dBm Input	+25 to +30 dBm Input
30.00	0.07	1.22	10.09	11.30	11.87	12.51	0.15	0.11	0.13
300.00	0.10	1.02	9.37	10.67	11.55	12.75	0.16	0.18	0.24
900.00	0.21	1.04	8.92	10.85	12.22	12.08	0.24	0.27	-0.03
1300.00	0.18	1.05	8.77	11.50	10.49	6.74	0.34	-0.20	-0.75
1500.00	0.22	1.05	9.06	11.01	5.84	7.46	0.24	-1.03	0.32
2000.00	0.25	1.09	9.13	10.52	5.62	6.99	0.17	-0.98	0.27
2400.00	0.29	1.14	9.23	8.38	4.95	9.75	-0.11	-0.69	0.96
3000.00	0.31	1.20	9.08	5.04	3.07	7.54	-0.51	-0.39	0.89
3600.00	0.35	1.16	8.82	0.91	6.65	10.11	-0.99	1.15	0.69
4200.00	0.43	1.16	8.09	0.36	5.21	9.54	-0.97	0.97	0.87
4800.00	0.47	1.16	6.65	1.32	5.03	9.97	-0.67	0.74	0.99
5600.00	0.50	1.17	4.19	0.92	4.87	9.28	-0.41	0.79	0.88
6000.00	0.60	1.11	1.99	3.06	7.63	13.47	0.13	0.91	1.17
6400.00	0.65	1.04	-0.49	1.96	6.79	12.21	0.31	0.97	1.08
7000.00	0.84	1.10	-2.20	2.57	6.80	11.98	0.60	0.85	1.04





COAXIAL

Limiter

VLM-73-1W-S+

50Ω Broadband 30 to 7000 MHz +12 to +30 dBm SMA Female to SMA Male

TYPICAL PERFORMANCE GRAPHS

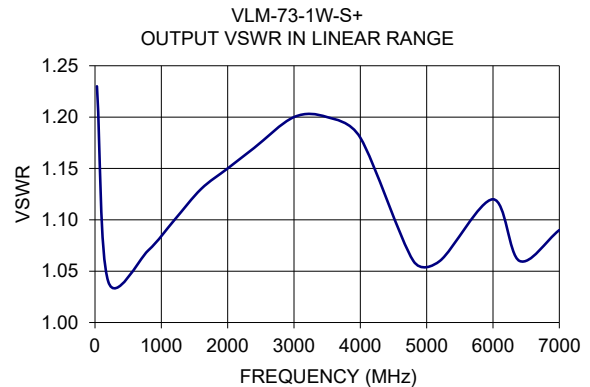
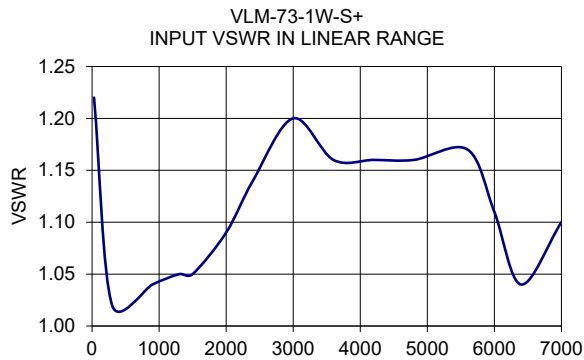
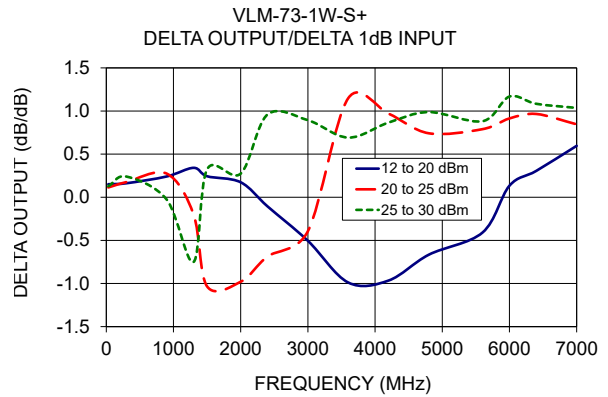
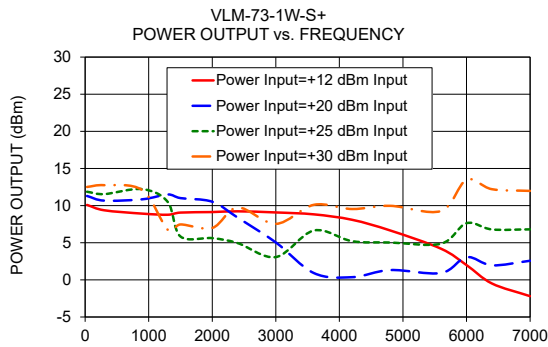
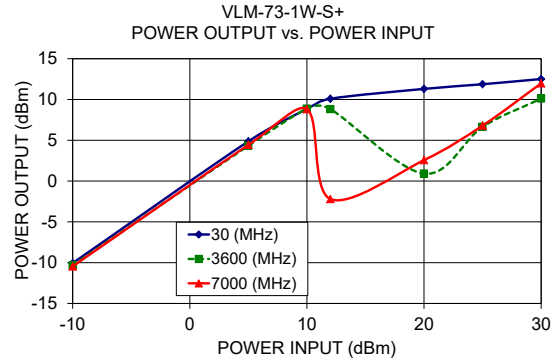
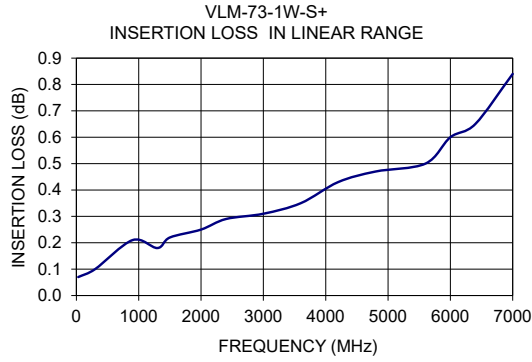



COAXIAL

Limitter

VLM-73-1W-S+

Mini-Circuits

50Ω Broadband 30 to 7000 MHz +12 to +30 dBm SMA Female to SMA Male

COAXIAL CONNECTIONS³

Function	Connectors
INPUT	SMA FEMALE
OUTPUT	SMA MALE

3. Suggested Connections. For reverse connections, consult Mini-Circuits.

CASE STYLE DRAWING

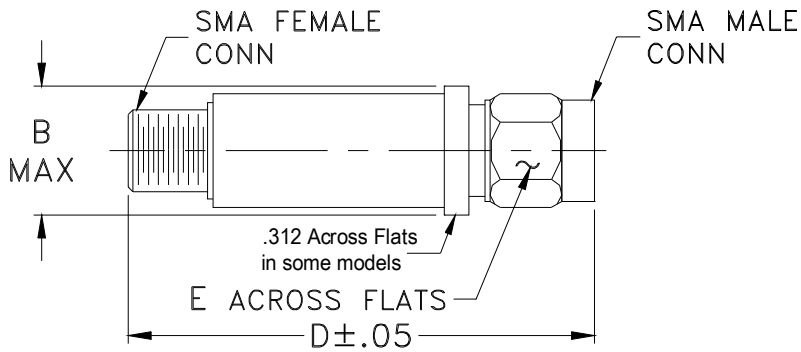

OUTLINE DIMENSIONS (Inches/mm)

B	D	E	wt
.410	1.43	.312	grams
10.41	36.32	7.92	10.0

PRODUCT MARKING*: VLM-73-1W-S+

*Marking may contain other features or characters for internal lot control.



COAXIAL

Limiter

VLM-73-1W-S+

50Ω Broadband 30 to 7000 MHz +12 to +30 dBm SMA Female to SMA Male

ADDITIONAL INFORMATION IS AVAILABLE ON OUR DASHBOARD

[CLICK HERE](#)

Performance Data & Graphs	Data Graphs S-Parameter (S2P Files) Data Set (.zip file)
Case Style	FF704
RoHS Status	Compliant
Environmental Ratings	ENV28

NOTES

- A. Performance and quality attributes and conditions not expressly stated in this specification document are intended to be excluded and do not form a part of this specification document.
- B. Electrical specifications and performance data contained in this specification document are based on Mini-Circuit's applicable established test performance criteria and measurement instructions.
- C. The parts covered by this specification document are subject to Mini-Circuits standard limited warranty and terms and conditions (collectively, "Standard Terms"); Purchasers of this part are entitled to the rights and benefits contained therein. For a full statement of the standard terms and the exclusive rights and remedies thereunder, please visit Mini-Circuits' website at www.minicircuits.com/terms/viewterm.html

