



MMIC SURFACE MOUNT

Fixed Attenuator

XAT-3+

50Ω DC to 45 GHz 2 W 3 dB

THE BIG DEAL

- Wideband, DC to 45 GHz
- High Power Handling, 2 W
- Excellent Return Loss, Typ. 16 dB
- 1×1 mm, 2-Lead QFN-Style Package

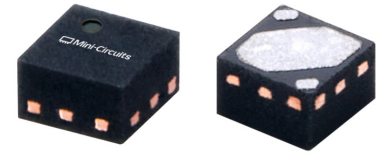

Generic photo used for illustration purposes only

APPLICATIONS

- Test & Measurement Equipment
- Satellite Communications
- Radar, EW, and ECM Defense Systems
- Telecom Infrastructure
- 5G sub-6 GHz and mmW

FUNCTIONAL DIAGRAM (TOP VIEW)

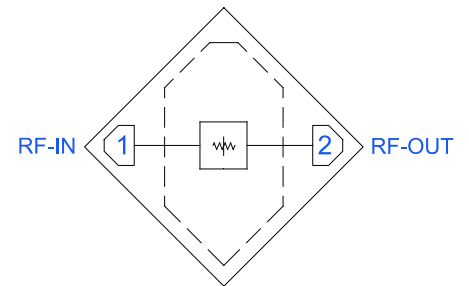

PRODUCT OVERVIEW

The XAT-3+ sets a new benchmark in RF component miniaturization as the smallest MMIC attenuator by virtue of its 2-lead, 1×1 mm QFN package, which enables unprecedented space savings in next-generation high-density PCB designs. Fabricated on a robust GaAs semiconductor process, its bidirectional, fully absorptive design delivers exceptional passband flatness, maintains excellent return loss throughout the entire band, and delivers consistent and repeatable performance from DC to 45 GHz. With up to 2 W input power handling, the XAT-3+ is perfectly suited for space-constrained, high frequency applications, including Test & Measurement, Satellite Communications, Radar Systems, EW/ECM Defense Systems, Telecom Infrastructure, and 5G networks.

KEY FEATURES

Features	Advantages
Wideband Operation, DC to 45 GHz	Flat attenuation response from DC to 45 GHz supports a wide array of applications including Test & Measurement Equipment, Satellite Communications, Radar, EW, ECM Defense Systems, Telecom, & 5G applications.
Excellent Return Loss	Excellent Return Loss across the entire passband minimizes reflections and enables flexibility to implement anywhere within wideband signal chains.
1×1 mm 2-Lead QFN-Style Package	Ultra-compact footprint saves space in dense layouts while providing low inductance and excellent thermal contact to the PCB. Innovative industry-leading packaging allows for ease of assembly in high-volume manufacturing processes.

REV. A
ECO-029664
XAT-3+
MCL NY
260521





MMIC SURFACE MOUNT

Fixed Attenuator

XAT-3+

50Ω DC to 45 GHz 2 W 3 dB

ELECTRICAL SPECIFICATIONS^{1,2} AT +25 °C, 50Ω, UNLESS NOTED OTHERWISE

Parameter	Condition (GHz)	Min.	Typ.	Max.	Units
Frequency Range		DC		45	GHz
Attenuation	0.01-10	2.6	3.1	3.6	dB
	10-20	2.6	3.2	3.8	
	20-30	2.8	3.3	4.0	
	30-40	2.4	3.2	4.1	
	40-45		2.8		
Input Return Loss	0.01-10		18		dB
	10-20		16		
	20-30		15		
	30-40		17		
	40-45		15		
Output Return Loss	0.01-10		18		dB
	10-20		16		
	20-30		15		
	30-40		17		
	40-45		15		

1. Tested on Mini-Circuits Characterization Test/Evaluation Board TB-XAT-3C+. See Figure 2. Board loss de-embedded to the device.

2. Bi-directional RF-IN and RF-OUT ports can be interchanged.



TYPICAL PERFORMANCE GRAPHS

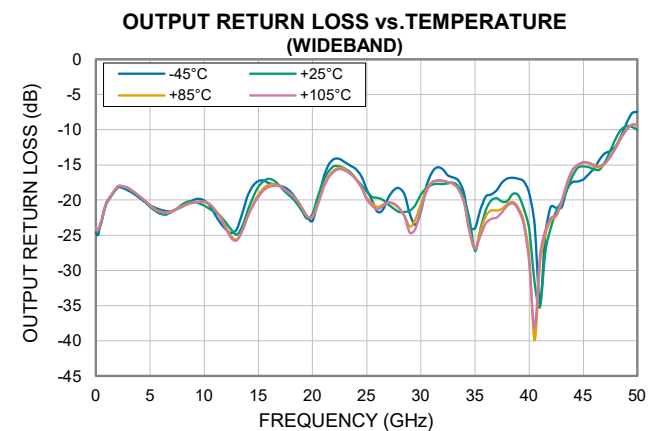
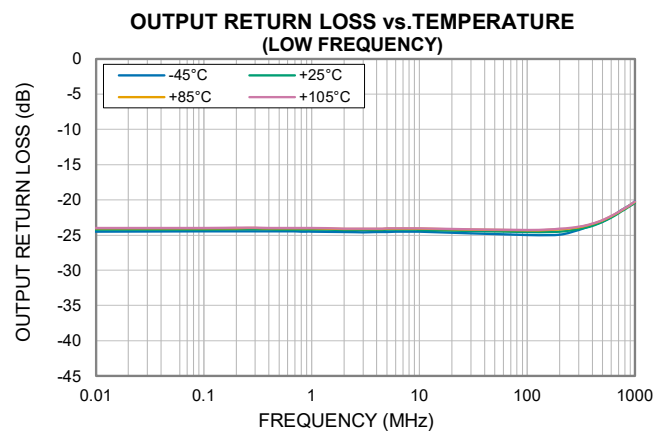
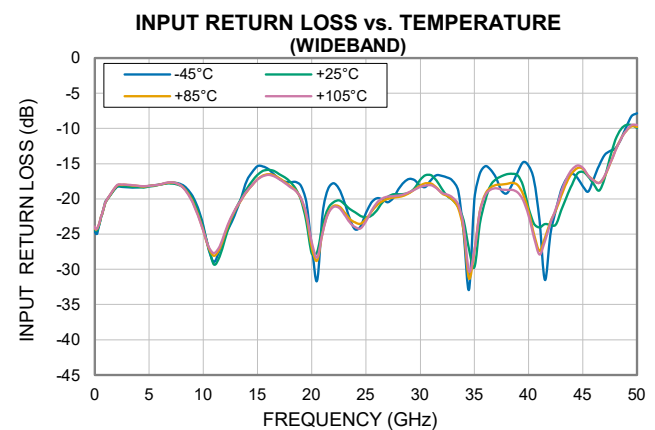
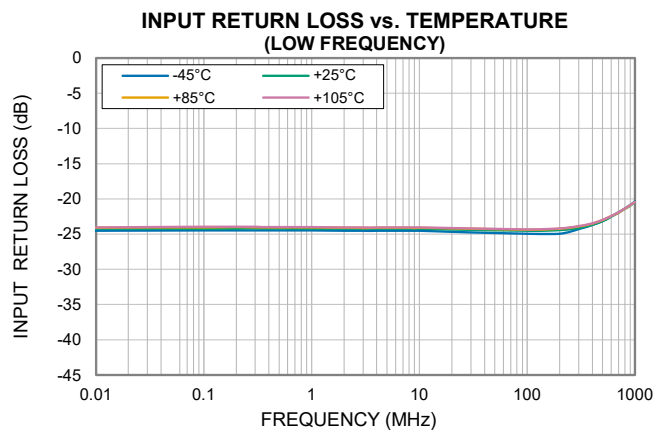
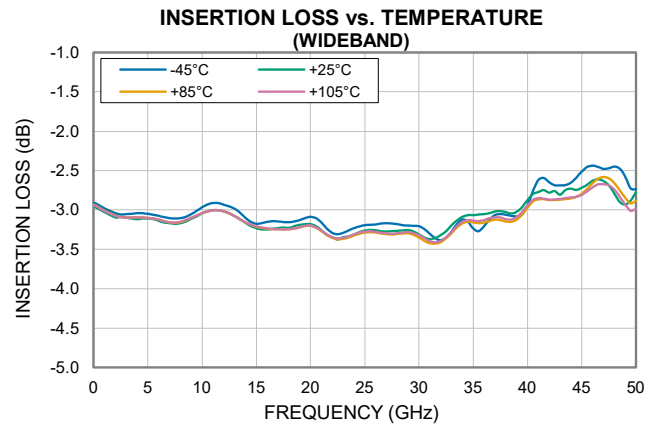
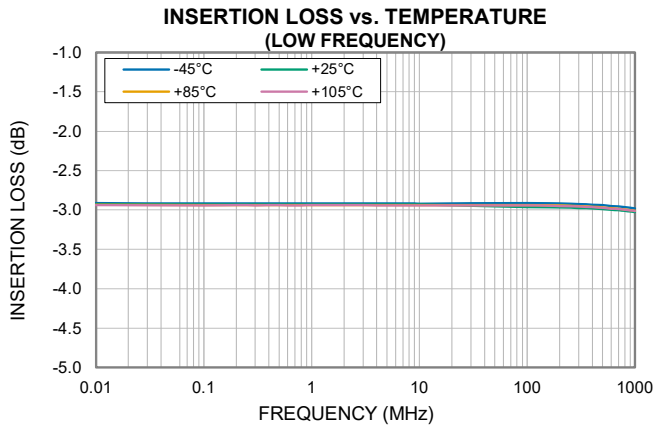



MMIC SURFACE MOUNT

Fixed Attenuator

XAT-3+

50Ω DC to 45 GHz 2 W 3 dB

ABSOLUTE MAXIMUM RATINGS³

Parameter	Ratings
Operating Temperature	-45 °C to +105 °C
Storage Temperature	-65 °C to +150 °C
RF Input Power ⁴	2 W

3. Permanent damage may occur if any of these limits are exceeded. Maximum ratings are not intended for continuous normal operation.

4. Power derated to 1 W at +105 °C.

ESD RATING

	Class	Voltage Range	Reference Standard
HBM	1C	> 1000 V	ANSI/ESDA/JEDEC JS-001-2023
CDM	C3	> 1000 V	ANSI/ESDA/JEDEC JS-002-2022



ESD HANDLING PRECAUTION: This device is designed to be Class 1C for HBM. Static charges may easily produce potentials higher than this with improper handling and can discharge into DUT and damage it. As a preventive measure Industry standard ESD handling precautions should be used at all times to protect the device from ESD damage.

MSL RATING

Moisture Sensitivity: MSL1 in accordance with IPC/JEDEC J-STD-020E /JEDEC J-STD-033C





MMIC SURFACE MOUNT

Fixed Attenuator

XAT-3+

50Ω DC to 45 GHz 2 W 3 dB

FUNCTIONAL DIAGRAM (TOP VIEW)

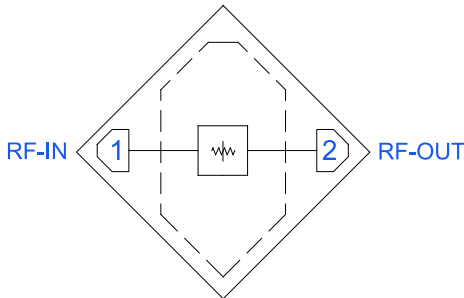

Figure 1. XAT-3+ Functional Diagram

PAD DESCRIPTION

Function	Pad #	Description (Refer to Figure 2)
RF-IN	1	RF-IN Pad connects to RF Input port.
RF-OUT	2	RF-OUT Pad connects to RF Output port.
GND	Paddle	Connects to ground.

CHARACTERIZATION TEST BOARD

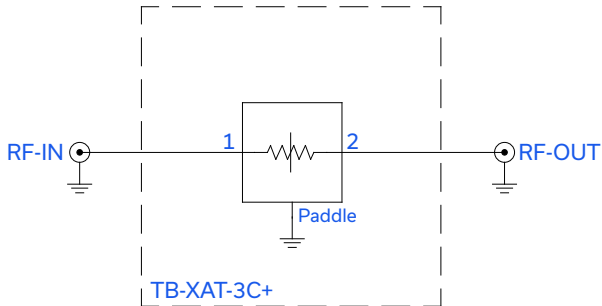

Figure 2. XAT-3+ Characterization and Application Circuit.

Electrical Parameters and Conditions

Insertion Loss and Return Loss are measured using N5247B PNA-X microwave network analyzer.

Conditions:

1. Insertion Loss and Return Loss: $P_{IN} = -5 \text{ dBm}$



CASE STYLE DRAWING

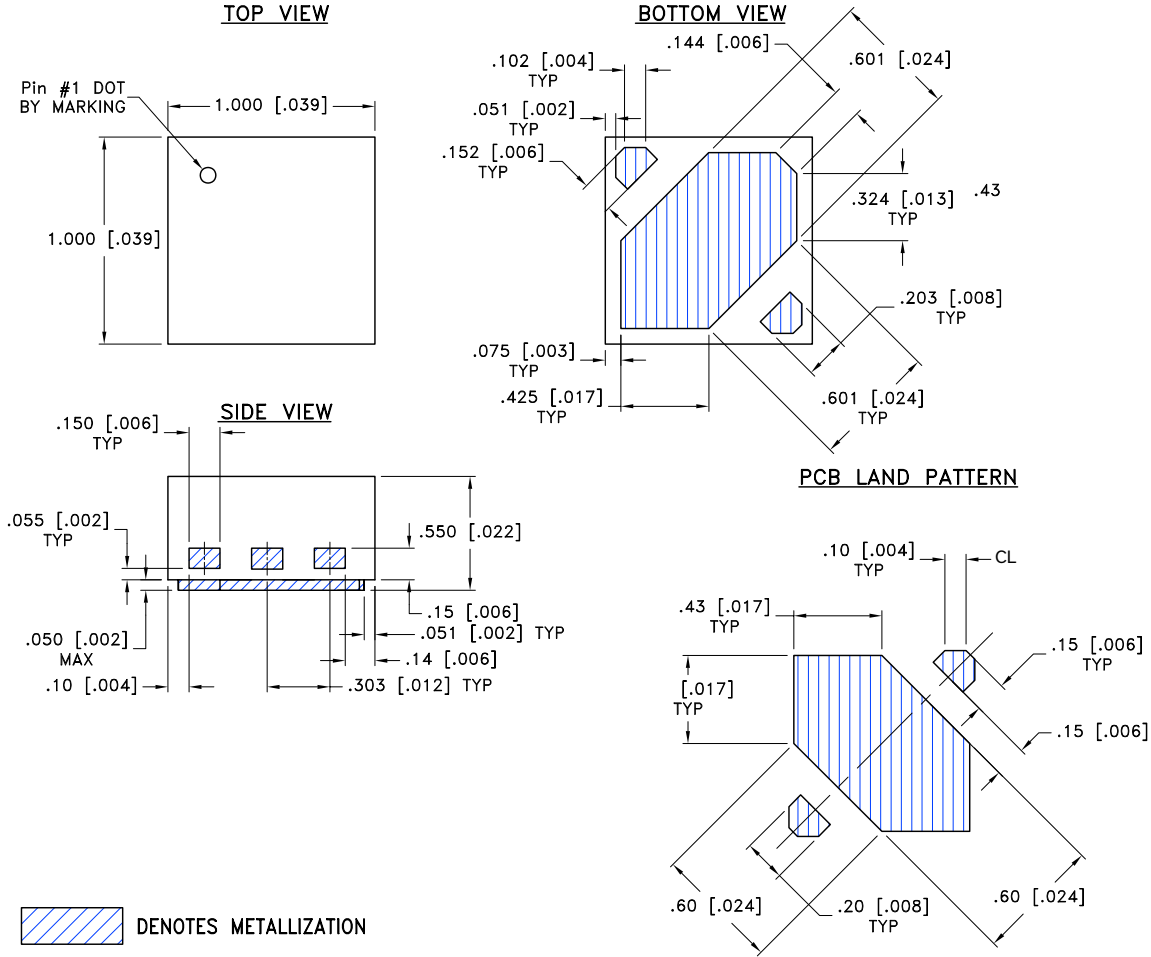

SUGGESTED PCB LAND PATTERN
Tolerance to be within ±.05

Weight: 0.002 grams
Dimensions are in mm [inches]. Tolerances: 3 Pl.±0.050 mm

PRODUCT MARKING

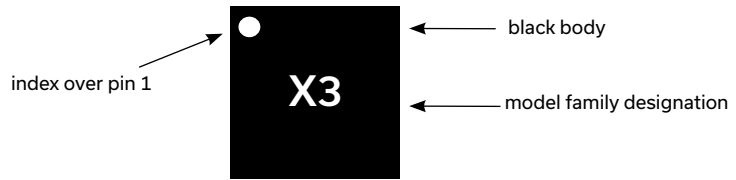

Marking may contain other features or characters for internal lot control



MMIC SURFACE MOUNT

Fixed Attenuator

XAT-3+

50Ω DC to 45 GHz 2 W 3 dB

ADDITIONAL DETAILED INFORMATION IS AVAILABLE ON OUR DASHBOARD [CLICK HERE](#)

Performance Data	Data Graphs S-Parameter (S2P Files) Data Set (.zip file)
Case Style	BBS3016 Plastic package, exposed paddle, lead finish: Matte-Tin
RoHS Status	Compliant
Tape & Reel Standard quantities available on reel	F66 7" reels with 20, 50, 100, 200, 500, 1000, 2000, or 3000 devices
Suggested Layout for PCB Design	PL-861
Evaluation Board	TB-XAT-3C+ Gerber File
Environmental Ratings	ENV08T1

Notes

- A. Performance and quality attributes and conditions not expressly stated in this specification document are intended to be excluded and do not form a part of this specification document.
- B. Electrical specifications and performance data contained in this specification document are based on Mini-Circuits' applicable established test performance criteria and measurement instructions.
- C. The parts covered by this specification document are subject to Mini-Circuits' standard limited warranty and terms and conditions (collectively, "Standard Terms"; Purchasers of this part are entitled to the rights and benefits contained therein). For a full statement of the standard terms and the exclusive rights and remedies thereunder, please visit Mini-Circuits' website at www.minicircuits.com/terms/viewterm.html

