



MMIC REFLECTIONLESS

# Low Pass Filter

## XLF-122H+

Mini-Circuits

50Ω DC to 1200 MHz

### THE BIG DEAL

- Match to 50Ω in the stop band, eliminates undesired reflections
- Cascadable
- Good stopband rejection, 35 dB typ.
- Temperature stable, up to +105°C
- Small size, 4 x 4 mm
- Protected by US Patents 8,392,495; 9,705,467, additional patent pending
- Protected by China Patent 201080014266.1
- Protected by Taiwan Patent I581494

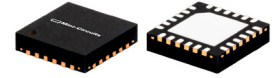

Generic photo used for illustration purposes only

CASE STYLE: DG1847

**+RoHS Compliant**

The +Suffix identifies RoHS Compliance. See our website for methodologies and qualifications

### APPLICATIONS

- Mobile
- ISM Applications
- Radio location
- Aeronautical radio navigation

### PRODUCT OVERVIEW

Mini-Circuits' XLF-122H+ three-section reflectionless filter employs a novel filter topology which absorbs and terminates stop band signals internally rather than reflecting them back to the source. This new capability enables unique applications for filter circuits beyond those suited to traditional approaches. Traditional filters are reflective in the stop band, sending signals back to the source at 100% of the power level. These reflections interact with neighboring components and often result in inter-modulation and other interferences. Reflectionless filters eliminate stop band reflections, allowing them to be paired with sensitive devices and used in applications that otherwise require circuits such as isolation amplifiers or attenuators.

### KEY FEATURES

| Features                                      | Advantages   |
|---|--|
| Reflectionless Technology                     | Reflectionless filters absorb unwanted signals, preventing reflections back to the source. This reduces generation of additional unwanted signals without the need for extra components like attenuators, improving system dynamic range and saving board space. |
| 50Ω Match in Stopband                         | Reflectionless filters maintain good impedance matching in the stopband, allowing for integration with high gain, wideband amplifiers without the risk of creating out-of-band instabilities.  |
| Excellent RF Performance Repeatability        | Fabricated on a GaAs process, X-series filters are inherently repeatable for large-volume production.  |
| Excellent Stability over temperature          | With ±0.3 dB variation over temperature, is ideal for use in wide temperature range applications without the need for additional temperature compensation.   |
| Excellent Power Handling in a Compact Package | High power handling extends the usability of these filters to the transmit path for inter-stage filtering.   |

REV. A  
 ECO-020598  
 XLF-122H+  
 MCL NY  
 240117





### ELECTRICAL SPECIFICATIONS<sup>1</sup> AT 25°C

| Parameter | F#                | Frequency (MHz) | Min.        | Typ. | Max. | Unit |    |
|-----------|-------------------|-----------------|-------------|------|------|------|----|
| Passband  | Insertion Loss    | DC - F1         | DC - 1200   | —    | 1.9  | 3.0  | dB |
|           | Frequency Cut-off | F2              | 1400        | —    | 3.0  | —    |    |
|           | VSWR              | DC - F1         | DC - 1200   | —    | 1.3  | —    |    |
| Stopband  | Rejection         | F3 - F4         | 2300 - 2500 | 14   | 17   | —    | dB |
|           |                   | F4 - F5         | 2500 - 9500 | 32   | 35   | —    |    |
|           | VSWR              | F3 - F4         | 2300 - 2500 | —    | 1.3  | —    |    |
|           |                   | F4 - F5         | 2500 - 9500 | —    | 1.3  | —    |    |

1. Measured on Mini-Circuits Characterization Test Board TB-952-122H+

### ABSOLUTE MAXIMUM RATINGS<sup>4</sup>

| Parameter                                     | Ratings         |
|---|-----------------|
| Operating Temperature                         | -55°C to +105°C |
| Storage Temperature                           | -65°C to +150°C |
| RF Power Input, Passband (DC-F1) <sup>2</sup> | 7.9 W at 25°C   |
| RF Power Input, Stopband (F2-F5) <sup>3</sup> | 1.58 W at 25°C  |

- 2. Passband rating derates linearly to 3.9 W at 105°C ambient
- 3. Stopband rating derates linearly to 0.75 W at 105°C ambient
- 4. Permanent damage may occur if any of these limits are exceeded.

### SPECIFICATION DEFINITION

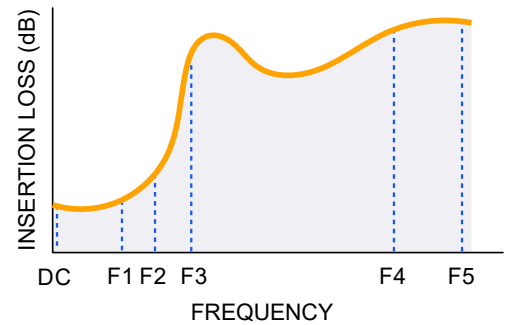



### SIMPLIFIED SCHEMATIC AND PAD DESCRIPTION

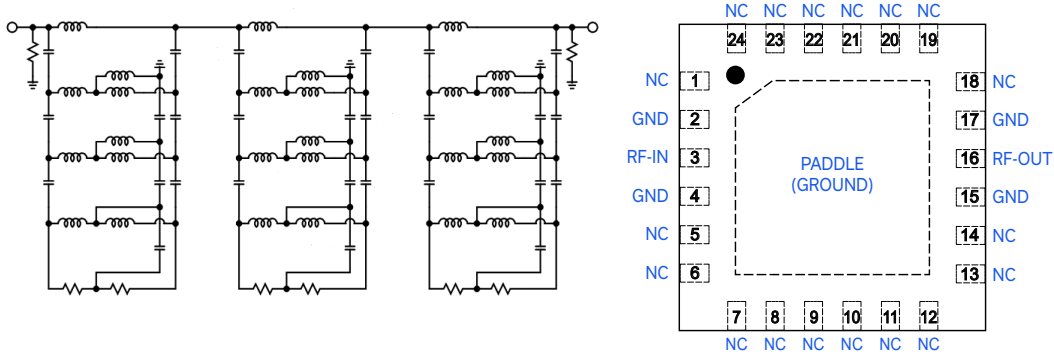

| Function            | Pad Number         | Description            |
|---------------------|--------------------|------------------------|
| RF-IN               | 3                  | RF Input Pad           |
| RF-OUT              | 16                 | RF Output Pad          |
| GND                 | 2,4,15,17 & paddle | Connected to ground    |
| NC (GND Externally) | 1, 5-14,18-24      | No internal connection |

### PRODUCT MARKING

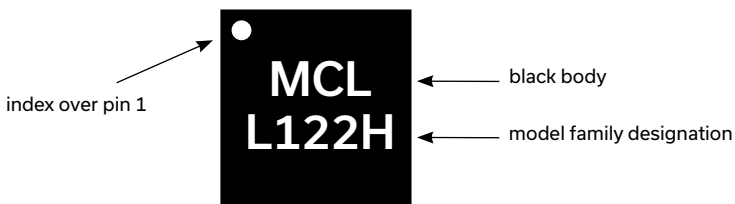

Marking may contain other features or characters for internal lot control



### TYPICAL PERFORMANCE DATA AT 25°C

| Frequency (MHz) | Insertion Loss (dB) | VSWR (:1) |
|-----------------|---------------------|-----------|
| 10              | 1.38                | 1.21      |
| 100             | 1.39                | 1.22      |
| 500             | 1.67                | 1.35      |
| 1000            | 2.27                | 1.35      |
| 1200            | 2.56                | 1.26      |
| 1400            | 2.95                | 1.15      |
| 1500            | 3.22                | 1.13      |
| 1700            | 4.04                | 1.19      |
| 2000            | 6.76                | 1.25      |
| 2300            | 17.30               | 1.23      |
| 2500            | 40.85               | 1.27      |
| 3500            | 48.50               | 1.49      |
| 3500            | 48.50               | 1.49      |
| 4500            | 36.76               | 1.28      |
| 5500            | 66.85               | 1.10      |
| 6500            | 60.62               | 1.12      |
| 8000            | 46.80               | 1.45      |
| 9500            | 41.71               | 1.78      |

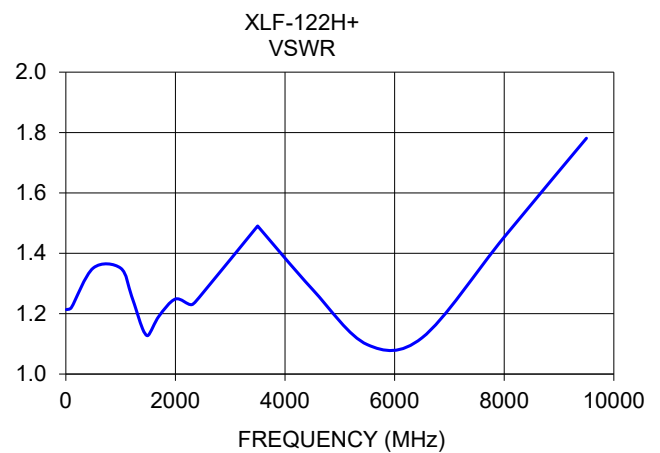



MMIC REFLECTIONLESS

# Low Pass Filter

## XLFB-122H+

Mini-Circuits

ADDITIONAL DETAILED TECHNICAL INFORMATION IS AVAILABLE ON OUR DASH BOARD. TO ACCESS [CLICK HERE](#)

|  |   |
|--|---|
| <b>Performance Data and Graphs</b>                               | Data<br>Graphs<br>S-Parameter (S3P Files) Data Set (.zip file)                                      |
| <b>Case Style</b>  | DG1847<br>Plastic package, exposed paddle lead finish: matte-tin                                    |
| <b>Tape &amp; Reel<br/>Standard quantities available on reel</b> | F68<br>7" reels with 20, 50, 100, 200, 500 ,1000 devices<br>13" reels with 2000, 3000, 4000 devices |
| <b>Suggested Layout for PCB Design</b>                           | PL-519  |
| <b>Evaluation Board</b>  | TB-952-122H+  |
| <b>Environmental Ratings</b>                                     | ENV82   |

### ESD RATING

Human body model (HBM): Class 1A (Pass 250V) in accordance with ANSI/ESD 5.1-2001



### REFLECTIONLESS FILTER APPLICATION NOTE

Application Circuit Example: Pairing mixers with reflectionless filters to improve system dynamic range

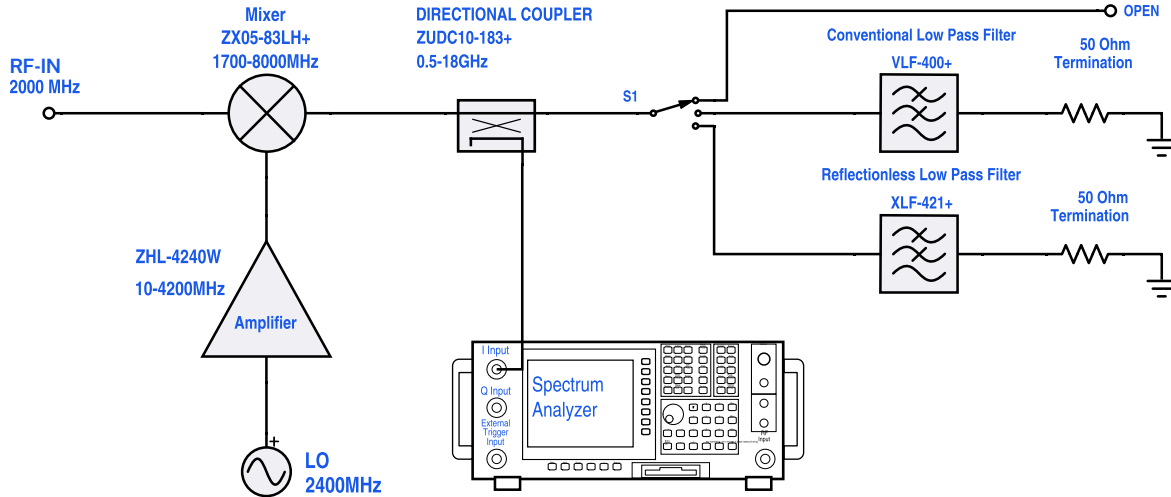

Test block diagram: IF output reflection spectrum with single input frequency

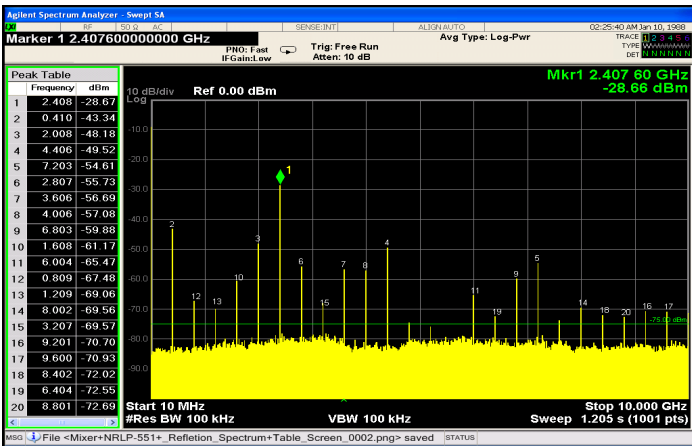

Figure 1. IF output reflection spectrum without filter

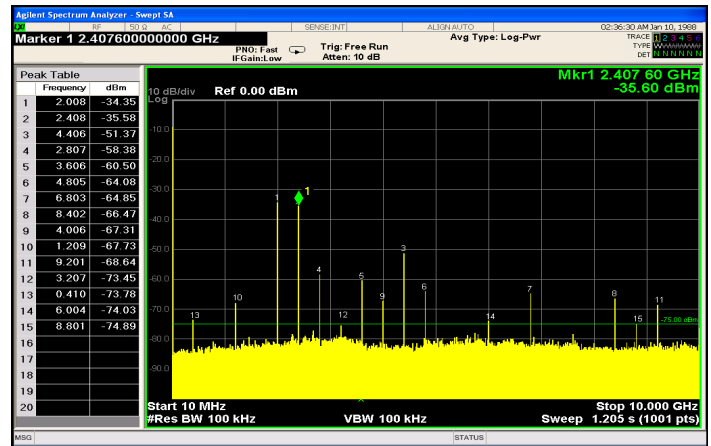
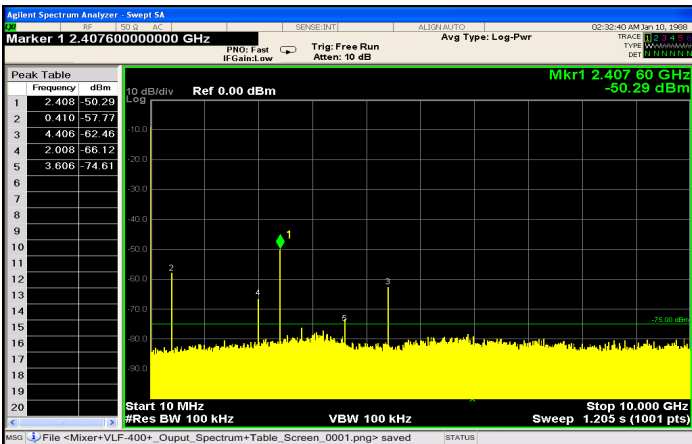

Figure 2. IF output reflection spectrum with conventional filter



An application circuit was assembled to measure the IF reflection spectrum at the output of a mixer when the mixer is paired with a conventional filter versus a reflectionless filter.

While the conventional filter reduces the reflections present when the mixer is used alone (no filter), the reflectionless filter virtually eliminates those reflections altogether.

The reflected signal at marker 1 in the figures above exhibits a reduction of more than 20 dB from -28.7 dBm to -50.3 dBm when the reflectionless filter is used as compared to the conventional filter, thus eliminating unwanted spurious mixing products and improving system dynamic range.

For more information, refer to application note AN-75-007

- NOTES
- A. Performance and quality attributes and conditions not expressly stated in this specification document are intended to be excluded and do not form a part of this specification document.
  - B. Electrical specifications and performance data contained in this specification document are based on Mini-Circuit's applicable established test performance criteria and measurement instructions.
  - C. The parts covered by this specification document are subject to Mini-Circuits standard limited warranty and terms and conditions (collectively, "Standard Terms"); Purchasers of this part are entitled to the rights and benefits contained therein. For a full statement of the standard terms and the exclusive rights and remedies thereunder, please visit Mini-Circuits' website at [www.minicircuits.com/MCLStore/terms.jsp](http://www.minicircuits.com/MCLStore/terms.jsp)