



(LTCC) COAXIAL

High Pass Filter

ZHFG-K2500+

50Ω 2700 to 14500 MHz 2.92mm Female

KEY FEATURES

- Low Insertion Loss, 1.4 dB Typ.
- Return Loss, 15 dB Typ.
- Stop Band Rejection, 55 dB Typ.
- Broadband Connectorized Package
- Power Handling: 4 Watts

APPLICATIONS

- Test and Measurement Equipment
- Military Applications
- Telecommunications and Broadband Wireless Systems
- 5G Sub 6 GHz
- WiFi 6E and X-Band Radar



Generic photo used for illustration purposes only

PRODUCT OVERVIEW

ZHFG-K2500+ is a 50Ω high pass filter built in broadband connectorized package. Covering 2700-14500 MHz bandwidth, these units offer good matching within the passband and good rejection in stopband. ZHFG-K2500+ offer low insertion loss, and excellent power handling capability. It handles up to 4 W RF input power and provides a wide operating temperature range from -55°C to 125°C.

FUNCTIONAL DIAGRAM

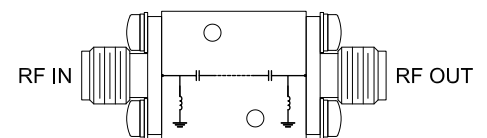

ELECTRICAL SPECIFICATIONS^{1,2} AT +25°C

Parameter		F#	Frequency (MHz)	Min.	Typ.	Max.	Units
Pass Band	Insertion Loss	F3-F4	2700 - 3500	—	2.5	—	dB
		F4-F5	3500 - 13000	—	1.4	2.5	
		F5-F6	13000 - 14500	—	2.7	—	
Pass Band	Return Loss	F3-F4	2700 - 3500	—	15	—	dB
		F4-F5	3500 - 13000	—	14	—	
		F5-F6	13000 - 14500	—	10	—	
Stop Band	Rejection	DC-F1	DC - 1550	42	55	—	dB
		F1-F2	1550 - 1950	20	32	—	
	Freq. Cut-Off ³	F _c ³	2500	—	3	—	dB

1. This filter is bi-directional, RF1 and RF2 ports may be interchanged, see S-Parameters for actual performance.

2. This component should not be used as a DC-block. In applications where DC voltage and/or current is present at either the input or output ports, external DC blocking capacitors are required.

3. Typical variation ± 5%

ABSOLUTE MAXIMUM RATINGS⁴

Parameter	Ratings
Operating Temperature	-55 °C to +125 °C
Storage Temperature	-55 °C to +125 °C
Input Power ⁵	4 W @+25°C

4. Permanent damage may occur if any of these limits are exceeded.

5. Power rating applies only to signals within the passband. Power rating above +25°C operating temperature decreases linearly to 0.9 W at +125°C.

TYPICAL FREQUENCY RESPONSE AT +25°C

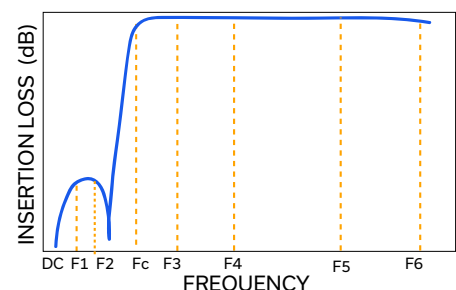



(LTCC) COAXIAL

High Pass Filter

ZHFG-K2500+

Mini-Circuits

50Ω 2700 to 14500 MHz 2.92mm Female

TYPICAL PERFORMANCE GRAPHS

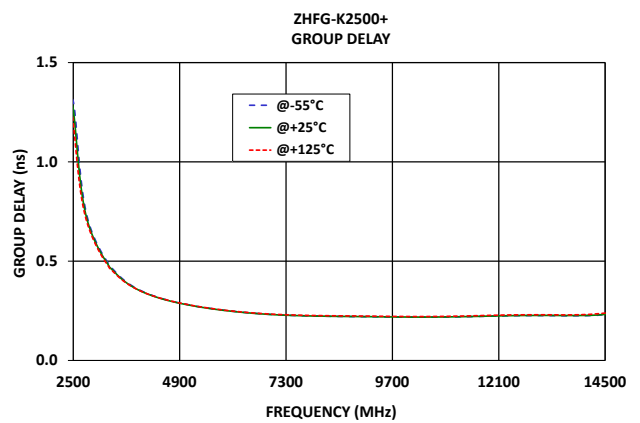
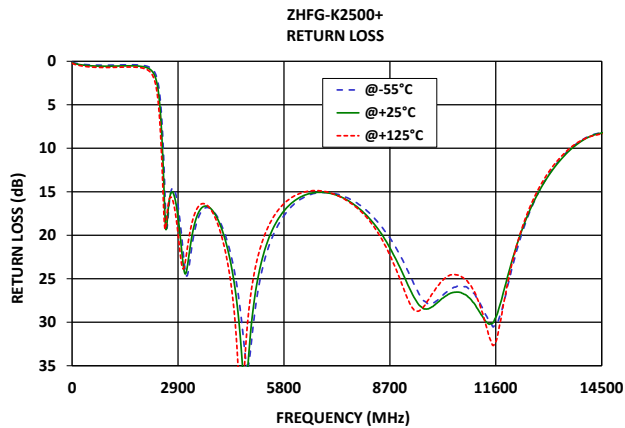
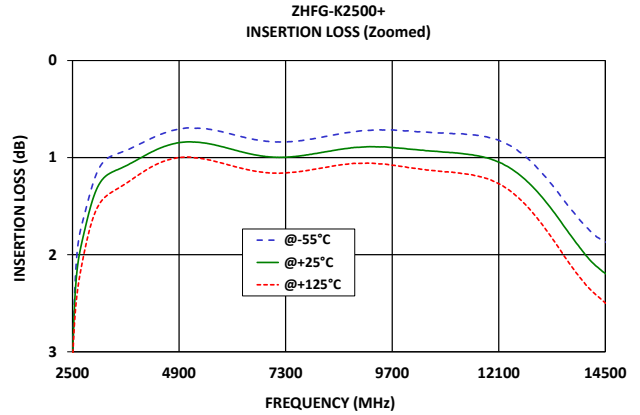
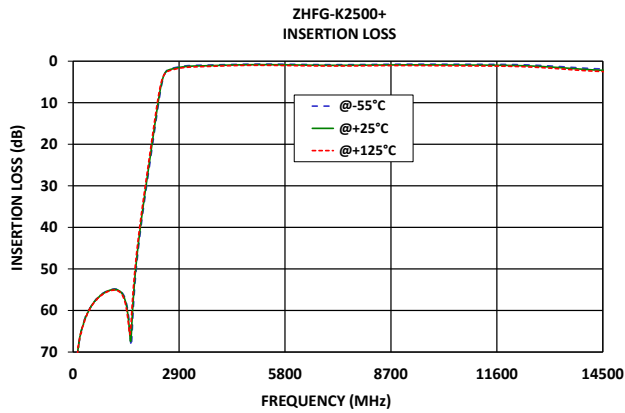



(LTCC) COAXIAL

High Pass Filter

ZHFG-K2500+

50Ω 2700 to 14500 MHz 2.92mm Female

CONNECTOR DESCRIPTION

Function	Marking on Unit	Connector
RF1 ¹	1	2.92mm Female
RF2 ¹	2	2.92mm Female

CASE STYLE DRAWING

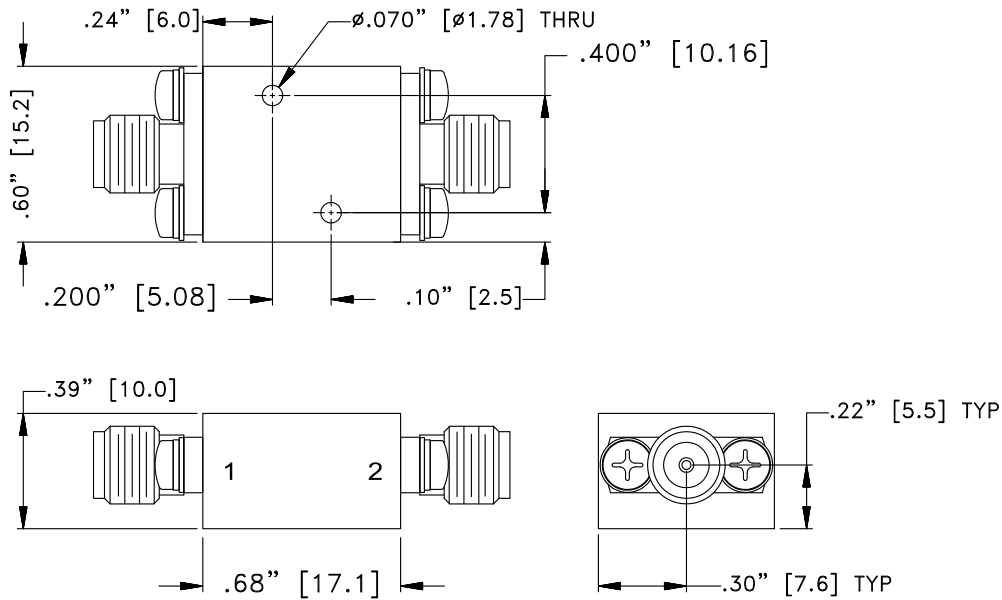

Unit weight: 24grams

Dimensions are in inches (mm). Tolerances: 2 Pl.±.050"; 3 Pl.±.015"

PRODUCT MARKING*: ZHFG-K2500+

*Marking may contain other features or characters for internal lot control.



(LTCC) COAXIAL

High Pass Filter

ZHFG-K2500+

50Ω 2700 to 14500 MHz 2.92mm Female

ADDITIONAL INFORMATION IS AVAILABLE ON OUR DASHBOARD

[CLICK HERE](#)

Performance Data & Graphs	<p>Data</p> <p>Graphs</p> <p>S-Parameter (S2P Files) Data Set (.zip file)</p>
Case Style	UK3042
RoHS Status	Compliant
Environmental Ratings	ENV124

NOTES

- A. Performance and quality attributes and conditions not expressly stated in this specification document are intended to be excluded and do not form a part of this specification document.
- B. Electrical specifications and performance data contained in this specification document are based on Mini-Circuits' applicable established test performance criteria and measurement instructions.
- C. The parts covered by this specification document are subject to Mini-Circuits' standard limited warranty and terms and conditions (collectively, "Standard Terms"); Purchasers of this part are entitled to the rights and benefits contained therein. For a full statement of the standard terms and the exclusive rights and remedies thereunder, please visit Mini-Circuits' website at www.minicircuits.com/terms/viewterm.html

