



(LTCC) COAXIAL

# High Pass Filter

## ZHFW-K6600+

50Ω 7.2 to 20 GHz 2.92mm Female

### KEY FEATURES

- Low Insertion Loss, 1.8 dB Typ.
- Return Loss, 9 dB Typ.
- Stop Band Rejection, 42 dB Typ.
- Broadband Connectorized Package.
- Power Handling: 2.5 Watts

### APPLICATIONS

- Test and Measurement Equipment.
- Radar, EW, and ECM Defense Systems.
- Back Haul Radio Systems.



Generic photo used for illustration purposes only

### PRODUCT OVERVIEW

ZHFW-K6600+ is a 50ohm high pass filter built in broad band connectorized package. Covering 7.2-20 GHz bandwidth, these units offer good matching within the passband and good rejection in stopband. ZHFW-K6600+ offer low insertion loss, and excellent power handling capability. It handles up to 2.5 W RF input power and provides a wide operating temperature range from -55°C to 125°C.

### FUNCTIONAL DIAGRAM

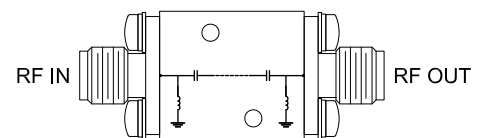

### ELECTRICAL SPECIFICATIONS<sup>1,2</sup> AT +25°C

Parameter		F#	Frequency (GHz)	Min.	Typ.	Max.	Units
Pass Band	Insertion Loss	F3-F4	7.2 - 9	—	2.0	—	dB
		F4-F5	9 - 15	—	1.0	2.2	
		F5-F6	15 - 20	—	1.8	—	
Pass Band	Return Loss	F3-F4	7.2 - 9	—	13	—	dB
		F4-F5	9 - 15	—	9	—	
		F5-F6	15 - 20	—	8	—	
Stop Band	Rejection	DC-F1	DC - 4.2	40	44	—	dB
		F1-F2	4.2 - 5.2	25	42	—	
	Freq. Cut-Off <sup>3</sup>	Fc <sup>3</sup>	6.8	—	3	—	dB

1. This filter is bi-directional, RF1 and RF2 ports may be interchanged, see S-Parameters for actual performance.

2. This component should not be used as a DC-block. In applications where DC voltage and/or current is present at either the input or output ports, external DC blocking capacitors are required.

3. Typical variation ± 5%

### ABSOLUTE MAXIMUM RATINGS<sup>4</sup>

Parameter	Ratings
Operating Temperature	-55 °C to +125 °C
Storage Temperature	-55 °C to +125 °C
Input Power <sup>5</sup>	2.5 W @25°C

4. Permanent damage may occur if any of these limits are exceeded.

5. Power rating applies only to signals within the passband. Power rating above +25°C operating temperature decreases linearly to 0.7 W at +125°C.

### TYPICAL FREQUENCY RESPONSE AT +25°C

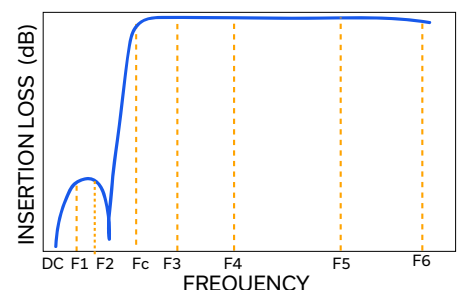



(LTCC) COAXIAL

# High Pass Filter

## ZHFW-K6600+

Mini-Circuits

50Ω 7.2 to 20 GHz 2.92mm Female

### TYPICAL PERFORMANCE GRAPHS

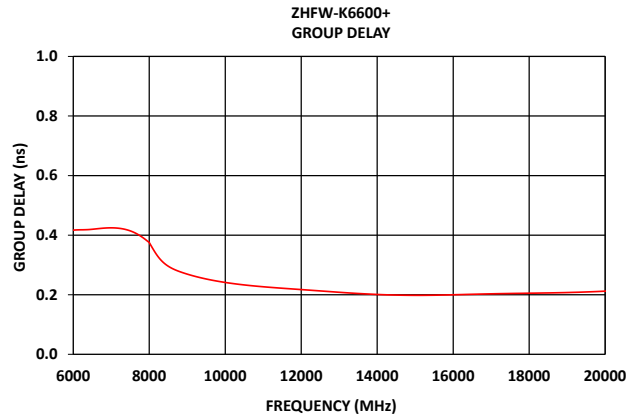
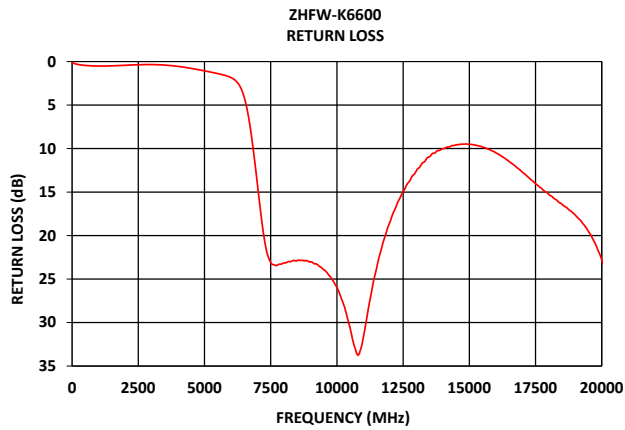
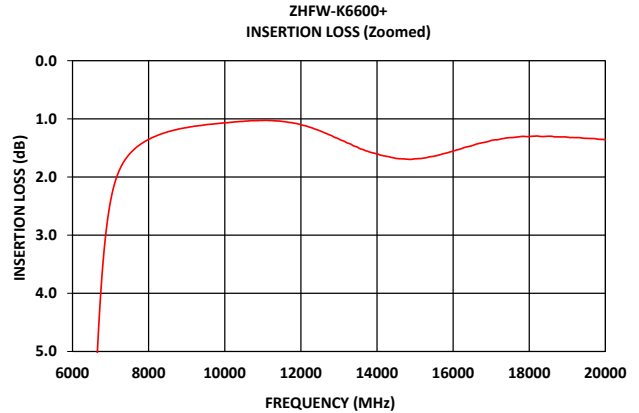
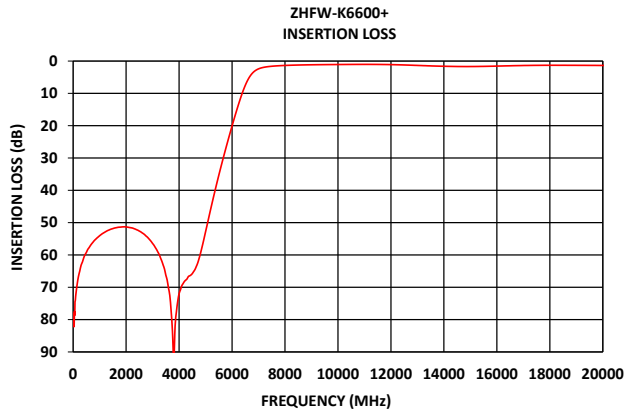



(LTCC) COAXIAL

# High Pass Filter

## ZHFW-K6600+

50Ω 7.2 to 20 GHz 2.92mm Female

### CONNECTOR DESCRIPTION

Function	Marking on Unit	Connector
RF1 <sup>1</sup>	1	2.92mm Female
RF2 <sup>1</sup>	2	2.92mm Female

### CASE STYLE DRAWING

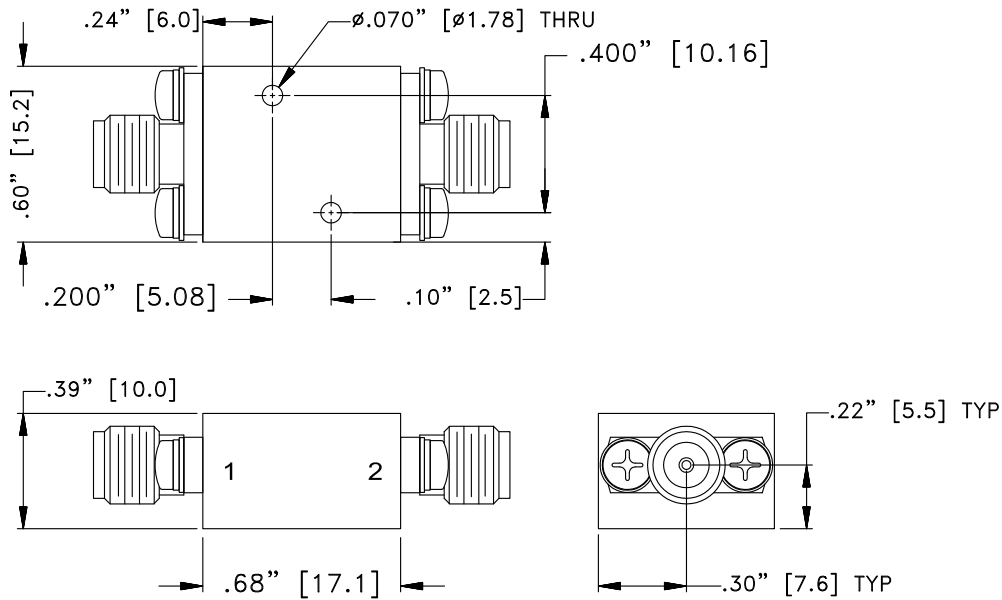

Unit weight: 24grams

Dimensions are in inches (mm). Tolerances: 2 Pl.±.050"; 3 Pl.±.015"

**PRODUCT MARKING\*:** ZHFW-K6600+

\*Marking may contain other features or characters for internal lot control.



(LTCC) COAXIAL

# High Pass Filter

## ZHFW-K6600+

50Ω 7.2 to 20 GHz 2.92mm Female

ADDITIONAL INFORMATION IS AVAILABLE ON OUR DASHBOARD

[CLICK HERE](#)

Performance Data & Graphs	<p>Data</p> <p>Graphs</p> <p>S-Parameter (S2P Files) Data Set (.zip file)</p>
Case Style	UK3042
RoHS Status	Compliant
Environmental Ratings	ENV124

### NOTES

- A. Performance and quality attributes and conditions not expressly stated in this specification document are intended to be excluded and do not form a part of this specification document.
- B. Electrical specifications and performance data contained in this specification document are based on Mini-Circuits' applicable established test performance criteria and measurement instructions.
- C. The parts covered by this specification document are subject to Mini-Circuits' standard limited warranty and terms and conditions (collectively, "Standard Terms"); Purchasers of this part are entitled to the rights and benefits contained therein. For a full statement of the standard terms and the exclusive rights and remedies thereunder, please visit Mini-Circuits' website at [www.minicircuits.com/terms/viewterm.html](http://www.minicircuits.com/terms/viewterm.html)

