



COAXIAL

High Power Amplifier

ZHL-4W-422+ ZHL-4W-422X+

Mini-Circuits

50Ω 4W 500 to 4200 MHz

THE BIG DEAL

- High Power, 4 Watt
- Excellent IP3, +44 dBm typ.
- Excellent IP2, +45 dBm typ.
- High efficiency, 30% typ. at Saturation
- Class A Amplifier
- No damage with an open or short output load under full CW output Power¹
- Shuts off when base plate temperature exceeds +85°C
- Over voltage protection, shuts off above +35V
- Reverse Polarity Protected
- Unconditionally stable

Reduced Price
While
Stock Lasts!



Generic photo used for illustration purposes only

Model No.	ZHL-4W-422+	ZHL-4W-422X+ [▲]
Case Style	BT1972	
Connectors	SMA/D-SUB MALE	

+RoHS Compliant
The +Suffix identifies RoHS Compliance.
See our website for methodologies and qualifications

APPLICATIONS

- Transmitters
- Defense
- Amateur radio, FM, TV
- Laboratory use

ELECTRICAL SPECIFICATIONS AT 25°C

Parameter	Condition (MHz)	ZHL-4W-422+ ZHL-4W-422X+ [▲]			Units
		Min.	Typ.	Max.	
Frequency Range		500	—	4200	MHz
Gain ³	500 - 4200	20	25	—	dB
Gain Flatness ³	500 - 4200	—	±1.0	±1.5	dB
Output Power at 1dB compression	500 - 4200	+31	+34	—	dBm
Output Power at 3dB compression	500 - 4200	+33	+36	—	dBm
Noise Figure	500 - 4200	—	10	15	dB
Output third order intercept point ²	500 - 4200	+40	+44	—	dBm
Output second order intercept point ²	500 - 4200	+38	+45	—	dBm
Input VSWR ³	500 - 4200	—	1.6	2.0	:1
Output VSWR ³	500 - 4200	—	2.6	3.3	
Non-Harmonic Spurious at Pout=4W	500 - 4200	—	—	-60	dBc
Second and Third Harmonics at Pout=2W	500 - 4200	—	-10	—	dBc
DC Supply Voltage		—	+28	+30	V
Supply Current ⁴		—	2	3	A

1. At constant open or short load +28V nominal supply voltage
 2. Measured with 2 tones, 1 MHz apart, +20 dBm/tone
 3. Measurements with small signal, Pin=-+15dBm input
 4. Power Supply should be capable of delivering 6.0A at star up.

[▲] Heat sink and fan not included. Alternative heat sinking and heat removal must be provided by the user to limit maximum base-plate temperature to 85°C, in order to ensure proper performance. For reference, this requires thermal resistance of user's external heat sink to be 0.3°C/W max.

ABSOLUTE MAXIMUM RATINGS

Parameter	Ratings
Operating Temperature	-20°C to +50°C
Storage Temperature	-55°C to +100°C
Base Plate Temperature	+85°C
Input RF Power (no damage)	+20 dBm

Permanent damage may occur if any of these limits are exceeded.

D-SUB MALE CONNECTOR PIN CONNECTIONS*

Pin Function	Label on Unit	Pin#	Color	Gauge
None	N/C1, N/C2, N/C3, N/C4, N/C5	1,2,3,4,5	None	None
DC Input(+)	Vdc	6,7	Red	18 AWG
Ground	GND	8,9	Black	18 AWG

* Each amplifier includes an additional D-Sub connector (B20-99-53-1+) for mating with the amplifier.





COAXIAL

High Power Amplifier

ZHL-4W-422+
ZHL-4W-422X+

Mini-Circuits

50Ω 4W 500 to 4200 MHz

OUTLINE DRAWING FOR MODELS WITH HEATSINK

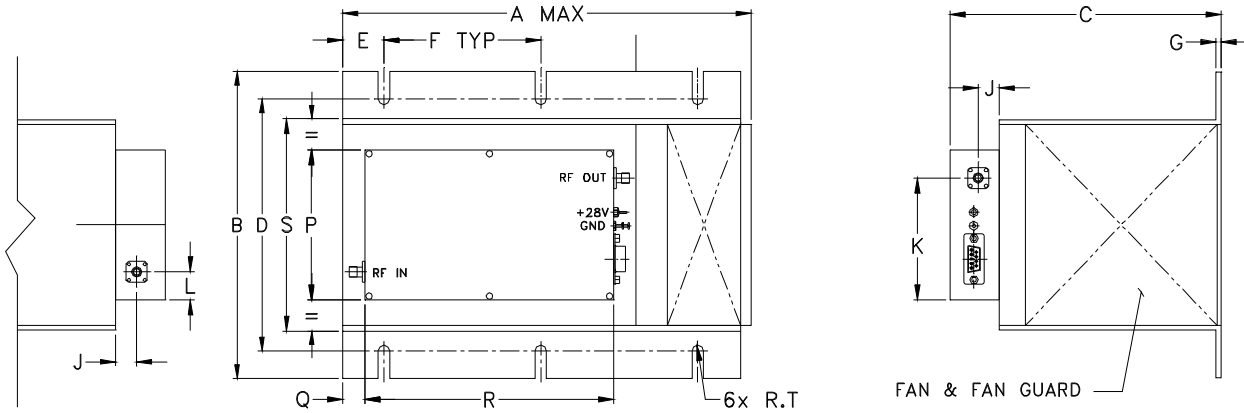

OUTLINE DRAWING FOR MODELS WITHOUT HEATSINK

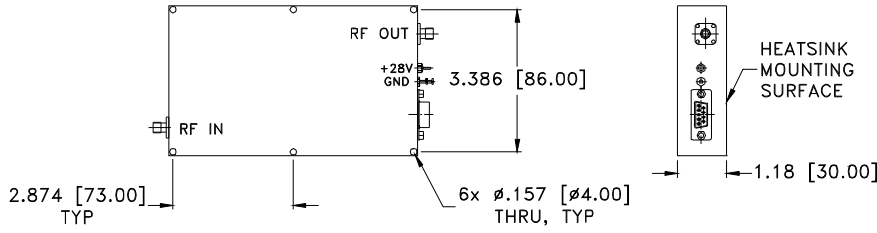

OUTLINE DIMENSIONS (Inch/mm)

A	B	C	D	E	F	G	J	K	L	P	Q	R	S	T	wt
9.85	7.3	6.4	6.43	1.00	3.75	.13	.51	2.91	.67	3.58	.53	5.94	5.1	.135 grams*	
250.19	185.42	162.56	163.32	25.40	95.25	3.30	12.95	73.91	17.02	90.93	13.46	150.88	129.54	3.43	4245

*580 grams without heatsink





COAXIAL

High Power Amplifier

ZHL-4W-422+ ZHL-4W-422X+

Mini-Circuits

50Ω 4W 500 to 4200 MHz

TYPICAL PERFORMANCE DATA / GRAPHS

FREQUENCY (MHz)	GAIN (dB)	DIRECTIVITY (dB)	VSWR (:1)		POUT at 1 dB COMPR. (dBm)	POUT at 3 dB COMPR. (dBm)	OUTPUT IP2 (dBm)	OUTPUT IP3 (dBm)
			IN	OUT				
500.00	24.96	70.34	1.46	1.73	37.07	38.37	64.09	48.83
800.00	26.25	63.77	1.44	2.49	37.03	38.06	58.97	48.49
1000.00	25.87	57.07	1.56	2.06	36.62	37.95	55.77	47.84
1200.00	25.31	60.91	1.58	1.84	36.23	37.71	53.67	47.96
1500.00	26.26	76.56	1.55	1.55	36.12	37.52	51.26	47.93
1800.00	25.80	62.48	1.56	1.58	35.92	37.54	53.45	47.82
2000.00	26.00	67.23	1.55	1.88	35.51	37.18	53.13	47.24
2200.00	25.33	63.44	1.59	2.18	35.10	36.44	52.53	46.37
2500.00	25.97	73.37	1.61	2.23	33.94	35.66	48.41	46.50
2800.00	25.44	57.05	1.55	1.37	33.15	35.00	48.19	44.77
3000.00	25.69	74.54	1.53	1.32	32.59	34.47	44.33	43.99
3500.00	25.82	58.97	1.31	1.79	33.33	35.07	47.70	45.04
3800.00	25.44	55.56	1.20	1.52	34.38	35.99	50.93	45.23
4000.00	26.50	52.65	1.22	1.32	33.91	35.56	47.54	45.17
4200.00	25.36	53.26	1.40	1.44	33.39	35.20	46.59	45.00

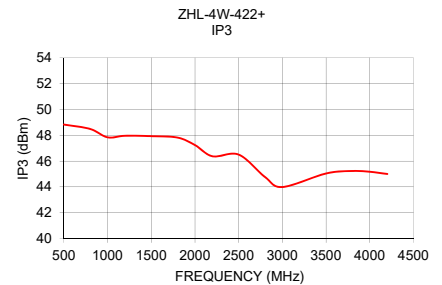
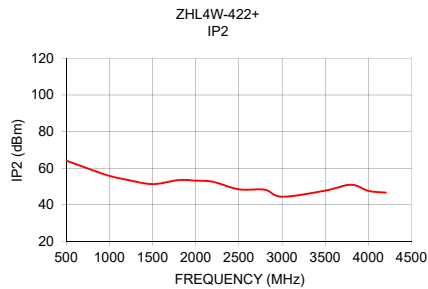
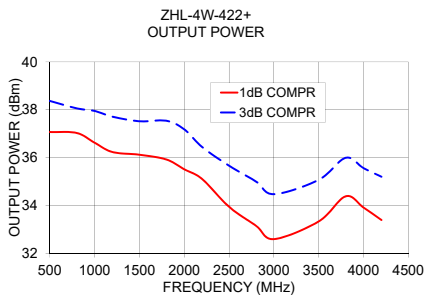
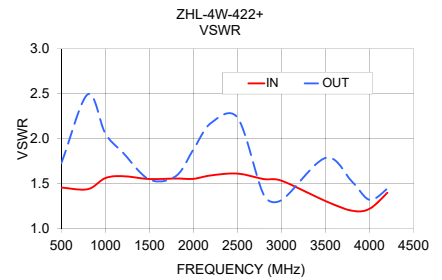
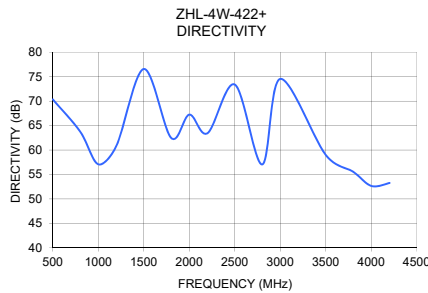
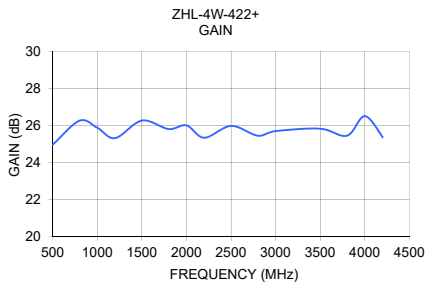

NOTES

- A. Performance and quality attributes and conditions not expressly stated in this specification document are intended to be excluded and do not form a part of this specification document.
- B. Electrical specifications and performance data contained in this specification document are based on Mini-Circuit's applicable established test performance criteria and measurement instructions.
- C. The parts covered by this specification document are subject to Mini-Circuits standard limited warranty and terms and conditions (collectively, "Standard Terms"); Purchasers of this part are entitled to the rights and benefits contained therein. For a full statement of the standard terms and the exclusive rights and remedies thereunder, please visit Mini-Circuits' website at www.minicircuits.com/terms/viewterm.html

