

Coaxial Frequency Mixer

NON-CATALOG

ZP-1LH+ ZP-1LH

Level 10 (LO Power +10 dBm) 2 to 600 MHz



BNC version shown
CASE STYLE: GG60

Connectors	Model
BNC	ZP-1LH+
SMA	ZP-1LH-S(+)

+RoHS Compliant

The +Suffix identifies RoHS Compliance. See our web site for RoHS Compliance methodologies and qualifications

Maximum Ratings

Operating Temperature	-55°C to 100°C
Storage Temperature	-55°C to 100°C
RF Power	50mW
IF Current	40mA

Permanent damage may occur if any of these limits are exceeded.

Coaxial Connections

LO	L
RF	R
IF	X

Outline Drawing

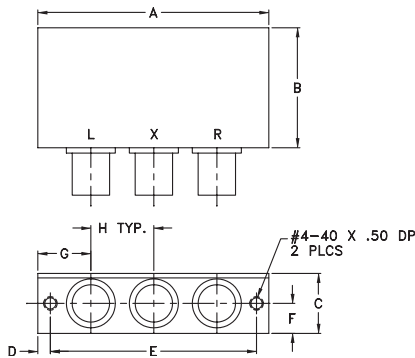

Outline Dimensions (inch/mm)

A	B	C	D	E	F	G	H	wt
2.31	1.20	.60	.125	2.062	.30	.53	.63	grams
58.67	30.48	15.24	3.18	52.37	7.62	13.46	16.00	75.0

Features

- low conversion loss, 6.0 dB typ.
- high L-R isolation, 50 dB typ., L-I, 50 dB typ.
- rugged shielded case

Applications

- VHF/UHF
- instrumentation

Electrical Specifications

FREQUENCY (MHz)		CONVERSION LOSS (dB)				LO-RF ISOLATION (dB)						LO-IF ISOLATION (dB)					
LO/RF	IF	Mid-Band m		Total Range Max.		L		M		U		L		M		U	
f_L-f_U		\bar{X}	σ	Max.	Max.	Typ.	Min.	Typ.	Min.	Typ.	Min.	Typ.	Min.	Typ.	Min.	Typ.	Min.
2-600	DC-600	6.0	0.17	7.0	8.0	70	50	50	30	42	25	65	45	50	30	41	22

1 dB COMP.: +5 dBm typ.

L = low range [f_L to $10 f_L$] M = mid range [$10 f_L$ to $f_U/2$] U = upper range [$f_U/2$ to f_U]
m = mid band [$2f_L$ to $f_U/2$]

Typical Performance Data

Frequency (MHz)		Conversion Loss (dB)	Isolation L-R (dB)	Isolation L-I (dB)	VSWR RF Port (:1)	VSWR LO Port (:1)
RF	LO	LO +10dBm	LO +10dBm	LO +10dBm	LO +10dBm	LO +10dBm
2.00	32.00	6.28	67.01	84.01	1.47	2.80
4.00	34.00	5.95	65.93	80.03	1.27	2.68
5.00	35.00	5.89	65.47	78.57	1.23	2.65
10.00	40.00	5.80	63.93	73.13	1.14	2.48
20.00	50.00	5.82	61.72	68.22	1.12	2.53
50.00	80.00	5.82	56.12	60.69	1.11	2.47
59.87	89.87	5.78	54.83	59.50	1.11	2.35
100.00	70.00	5.77	51.13	55.91	1.12	2.37
117.74	87.74	5.79	50.12	55.10	1.15	2.32
175.61	145.61	5.69	47.32	52.30	1.18	2.26
200.00	170.00	5.73	46.57	51.26	1.21	2.33
233.48	203.48	5.70	45.24	49.36	1.25	2.27
291.36	261.36	5.69	43.94	46.68	1.27	2.24
300.00	270.00	5.68	43.65	46.00	1.31	2.29
349.23	319.23	5.71	42.63	43.46	1.35	2.28
407.10	337.10	5.70	41.85	41.86	1.40	2.28
464.97	434.97	5.72	40.61	39.52	1.45	2.29
522.84	492.84	5.77	39.23	37.60	1.49	2.33
580.71	550.71	5.84	38.82	36.92	1.51	2.33
600.00	570.00	5.87	38.87	36.44	1.53	2.31

Electrical Schematic

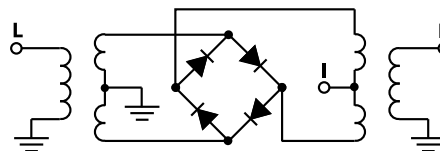

Notes

- Performance and quality attributes and conditions not expressly stated in this specification document are intended to be excluded and do not form a part of this specification document.
- Electrical specifications and performance data contained in this specification document are based on Mini-Circuit's applicable established test performance criteria and measurement instructions.
- The parts covered by this specification document are subject to Mini-Circuits standard limited warranty and terms and conditions (collectively, "Standard Terms"); Purchasers of this part are entitled to the rights and benefits contained therein. For a full statement of the Standard Terms and the exclusive rights and remedies thereunder, please visit Mini-Circuits' website at www.minicircuits.com/WCLStore/terms.jsp



Performance Charts

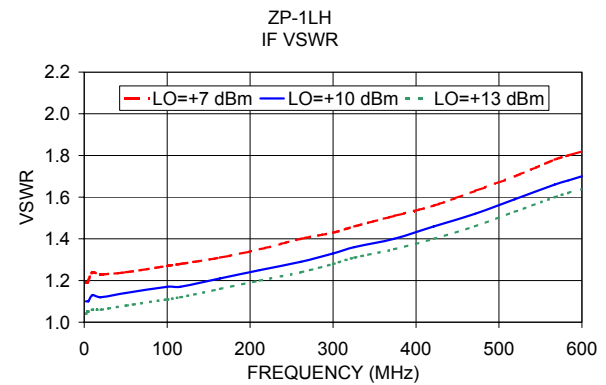
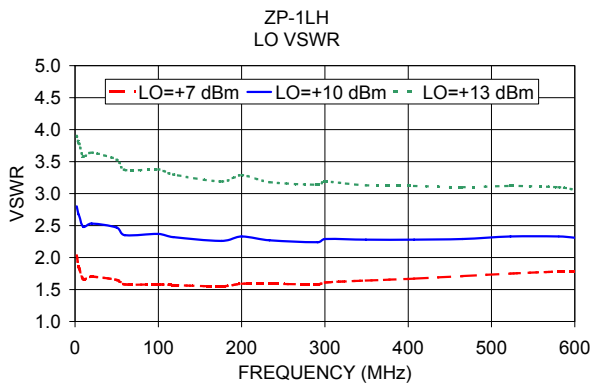
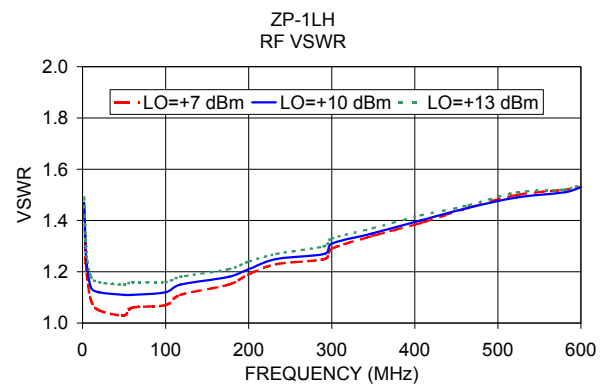
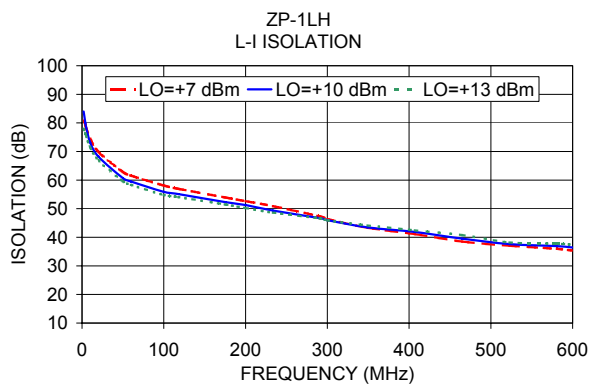
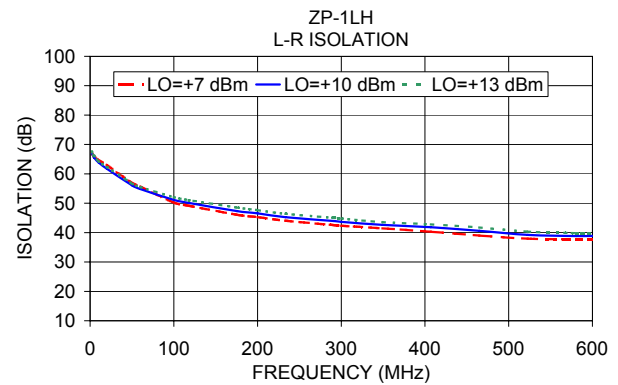
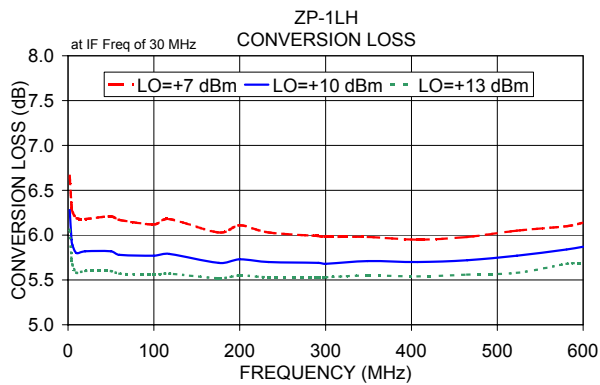

Notes

- A. Performance and quality attributes and conditions not expressly stated in this specification document are intended to be excluded and do not form a part of this specification document.
- B. Electrical specifications and performance data contained in this specification document are based on Mini-Circuit's applicable established test performance criteria and measurement instructions.
- C. The parts covered by this specification document are subject to Mini-Circuit's standard limited warranty and terms and conditions (collectively, "Standard Terms"); Purchasers of this part are entitled to the rights and benefits contained therein. For a full statement of the Standard Terms and the exclusive rights and remedies thereunder, please visit Mini-Circuit's website at www.minicircuits.com/MCLStore/terms.jsp

