

Low Noise, High Gain Wideband Amplifier

ZVA-24443G1+

50Ω 24 to 43.5 GHz¹

The Big Deal

- Extremely Low Noise Figure of 1.7 dB typ. through Q-Band
- High Gain of 45 dB typ., over 5G bands – 24 to 39 GHz
- Available with and without heatsink
- Operates with a single DC supply of +9 to +15 V
- Over-Voltage and Reverse Voltage protected



ZVA-24443G1+



ZVA-24443G1X+

Product Overview

Mini-Circuits' ZVA-24443G1+ is a co-axial, low noise, wideband and high gain amplifier operating from 24 GHz to 43.5 GHz¹. The model operates over a single positive supply range of +9 to +15 V, allowing users to choose their desired operating voltage. Internal DC-DC conversion circuitry maintains constant efficiency over the full input voltage range. The amplifier incorporates several DC-protection features such as Over-voltage, Reverse voltage and In-rush current that protects the amplifier from damage if mishandled during operation. The Amplifier is capable of delivering about 100mW (+20 dBm) of RF power over the entire band and has an excellent Noise figure performance of 1.7 dB, typ over the entire band, hence making it an ideal choice for applications with extremely demanding dynamic range requirements.

Key Features

Feature	Advantages
Wide-band amplifier, 24 to 43.5 GHz ¹	A single amplifier serves the need for applications including 5G bands (24 to 39 GHz), Q-Band SATCOM, Test & instrumentation etc.
<ul style="list-style-type: none">• High Gain• Low Noise• Medium RF power	The Amplifier is capable of providing high gain of over 45 dB typ. in the entire operating band with extremely Low noise of 1.7 dB typ. and good RF power of about +20 dBm.
Adjustable DC Supply voltage	The device is capable of operating from +9 to +15 V with constant DC power consumption.
DC Protection – <ul style="list-style-type: none">• Over-voltage• Reverse voltage• In-rush current	The internal DC circuitry allows the amplifier to be protected from any external mishandling that could lead to catastrophic failures in the field.

1. Amplifier is usable down to 22 GHz

Low Noise, High Gain Wideband Amplifier

ZVA-24443G1+

50Ω 24 to 43.5 GHz¹

Features

- Extremely Low Noise Figure, 1.7 dB typ.
- High Gain 45 dB typ.
- Output Power, +20 dBm (100mW) typ.
- Adjustable DC Voltage, +9 to +15V

Applications

- 5G (24-39 GHz)
- Q-Band SATCOM
- Test and Instrumentation



Generic photo used for illustration purposes only

Model No.	ZVA-24443G1+	ZVA-24443G1X+ ⁴
Case Style	T2704	
Connectors	2.92mm Female	

+RoHS Compliant

The +Suffix identifies RoHS Compliance. See our web site for RoHS Compliance methodologies and qualifications

Electrical Specifications at 25°C

Parameter	Condition (MHz)	Min.	Typ.	Max.	Units
Frequency Range ¹		24000	—	43500	MHz
Gain	24000 - 30000	38	43	—	dB
	30000 - 40000	38	45	—	
	40000 - 43500	40	48	—	
Noise Figure	24000 - 30000		1.75		dB
	30000 - 40000		1.50		
	40000 - 43500		1.75		
Output Power at 1dB compression	24000 - 30000		21		dBm
	30000 - 40000		23		
	40000 - 43500		21		
Output third order intercept point	24000 - 43500		27		dBm
Input VSWR	24000 - 30000		1.8		:1
	30000 - 40000		1.45		
	40000 - 43500		1.65		
Output VSWR ³	24000 - 30000		3.0		:1
	30000 - 40000		2.0		
	40000 - 43500		1.7		
Operating DC Voltage	24000 - 43500	+9	—	+15	V
Device Operating Current ² (at 9V DC)		—	—	375	mA
Device Operating Power at Operating DC Voltage		—	2.7	—	W

1. Amplifier is usable down to 22 GHz

2. DC Supply must be able to source at least 400mA DC at startup.

3. Open and short-circuit loads and not recommended at the amplifier output. Ensure proper 50 Ohm load before turning the amplifier "ON".

4. For units without heat-sink, limit the maximum base-plate temperature to 50°C to ensure proper performance. Alternative heat sinking and heat removal can be provided by the user with max. thermal resistance of 1.8°C/W. This allows the max. base plate temperature to be +85°C.

Maximum Ratings⁵

Parameter	Ratings
Operating Temperature (Ambient)	-40°C to 85°C
Storage Temperature	-55°C to 100°C
Total Power dissipation	3.5W
Input Power (CW)	+5 dBm
DC Operating Voltage	+16V

5. Permanent damage may occur if any of these limits are exceeded.



Outline Drawing

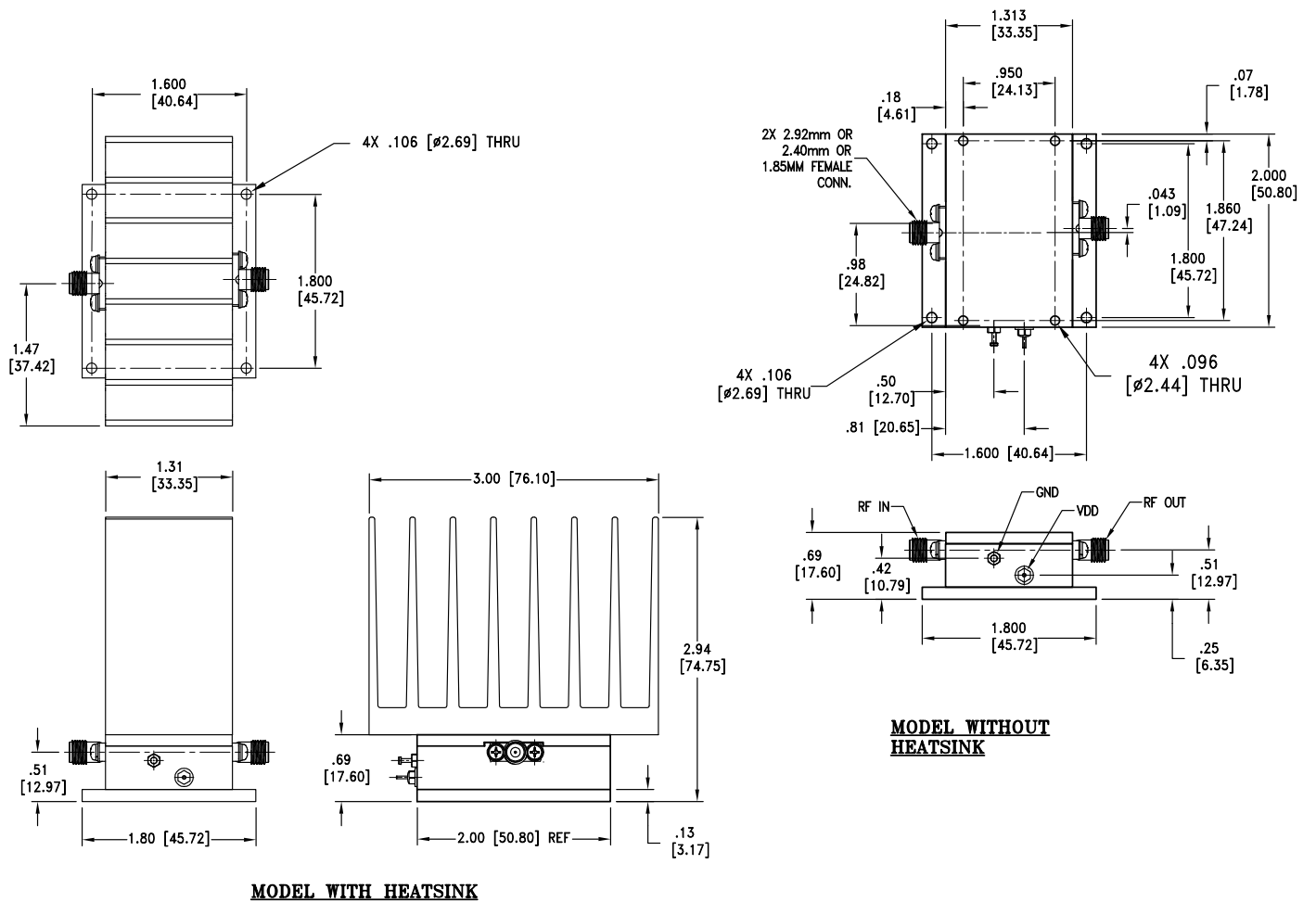

Weight: 350 grams; Weight without heatsink: 220 grams

Dimensions are in inches (mm). Tolerances: 2 Pl. ± .03; 3 Pl. ± .015

FREQUENCY (MHz)	GAIN (dB)	DIRECTIVITY (dB)	VSWR (:1)		NOISE FIGURE (dB)	P _{OUT} at 1 dB COMPR. (dBm)	P _{OUT} at SATURATION (dBm)	OIP ₃ (dBm)
	15V	15V	IN	OUT				
22000	45.69	46.34	2.60	2.21	2.66	21.38	22.02	29.48
24000	44.27	48.27	2.54	3.64	2.36	21.42	23.05	28.18
26000	42.88	58.65	1.93	3.93	2.10	20.47	22.77	27.54
28000	44.83	40.07	1.46	3.30	2.09	20.91	24.10	27.72
30000	45.93	39.76	1.76	3.18	1.84	21.90	24.25	26.14
32000	46.26	48.93	1.82	2.72	1.72	22.89	24.39	25.79
34000	45.75	31.21	1.55	1.75	1.76	23.82	24.44	26.67
36000	44.69	38.86	1.33	1.66	1.74	23.39	24.11	27.34
38000	45.25	38.19	1.18	1.96	1.88	22.12	23.66	26.79
40000	48.37	30.81	1.37	1.85	1.82	22.23	23.62	26.05
42000	49.42	38.69	1.49	1.50	1.47	20.92	21.99	26.15
43500	48.80	45.64	1.76	1.62	1.78	20.55	21.24	25.57

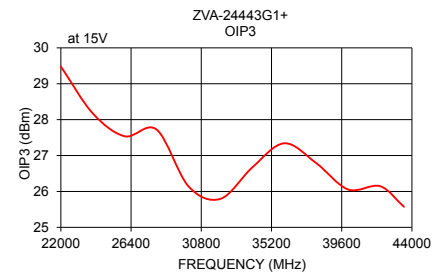
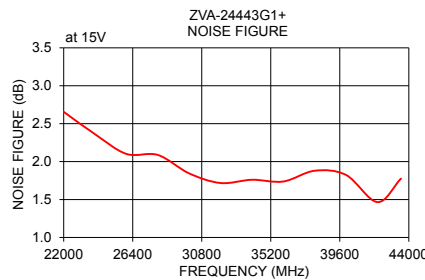
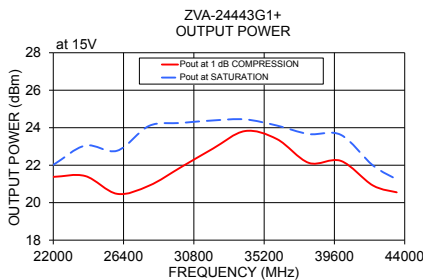
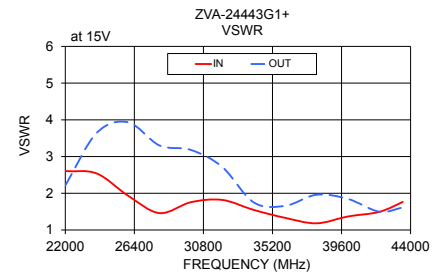
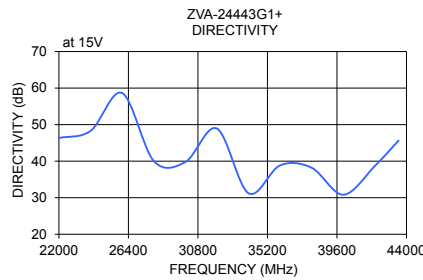
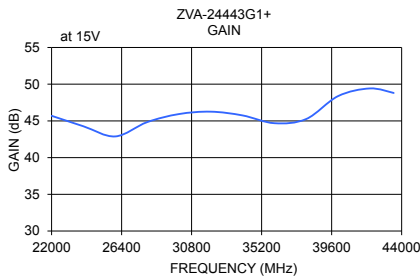

Additional Notes

- Performance and quality attributes and conditions not expressly stated in this specification document are intended to be excluded and do not form a part of this specification document.
- Electrical specifications and performance data contained in this specification document are based on Mini-Circuit's applicable established test performance criteria and measurement instructions.
- The parts covered by this specification document are subject to Mini-Circuits standard limited warranty and terms and conditions (collectively, "Standard Terms"); Purchasers of this part are entitled to the rights and benefits contained therein. For a full statement of the Standard Terms and the exclusive rights and remedies thereunder, please visit Mini-Circuits' website at www.minicircuits.com/MCLStore/terms.jsp