



CAVITY

Bandpass Filter ZVBP MODEL SERIES

50Ω DC to 57 GHz

THE BIG DEAL

- Very low insertion loss with excellent power handling
- Sharp roll-off with wide stopband
- Passbands upto 36 GHz
- Stopband up to 57 GHz

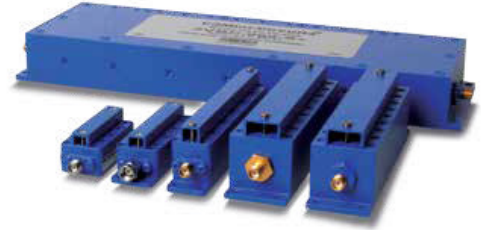

PRODUCT OVERVIEW

Mini-Circuits' cavity filters are designed by implementing resonant structures with very high Q and are ideal for narrow-band, high-selectivity applications. These designs can provide bandwidths as narrow as 3% with very high selectivity and excellent low noise floor. Low insertion loss combined with excellent power handling makes them well-suited for transmitter and receiver front end. Advanced filter design and construction enables stopband width greater than 3x the center frequency.

Mini-Circuits' cavity filters feature a special protective assembly to prevent accidental de-tuning that would otherwise require expensive replacement or return to factory for re-tuning. Precise machining allows realization of cavity filters with small form factors for applications where size is critical. Excellent repeatability across units is achieved through precise tuning and process control.

KEY FEATURES

Feature	Advantages
Low insertion loss	Low signal loss results in better SNR in receiver front end and better power delivery to antenna in transmitter.
Sharp roll-off	Higher selectivity results in better adjacent channel rejection and dynamic range
Wide stopband	Wide spur free band results in better receiver sensitivity
High power handling	Well suited for transmitter application
Protective assembly	Prevents accidental de-tuning of precisely tuned resonant circuit

REV. B
ECO-015165
ZVBP-25875-K+
EDU4315
URJ
221001





CAVITY

Bandpass Filter

ZVBP-25875-K+

50Ω 24.25 to 27.5 GHz 2.92mm-Female

FEATURES

- Low insertion loss, 2.4 dB typ.
- Good return loss, 18 dB typ.
- Great Rejection (60 to 100 dB typ.)
- Broad stopband performance up to 50 GHz
- Sharp roll-off



Generic photo used for illustration purposes only

Model No.	ZVBP-25875-K+
Case Style	UH3126
Connectors	2.92mm-F

APPLICATIONS

- Test & Measurement Equipment
- Radar, EW, and ECM Defense Systems

+RoHS Compliant

The +Suffix identifies RoHS Compliance. See our web site for RoHS Compliance methodologies and qualifications

ELECTRICAL SPECIFICATIONS AT¹ 25°C

Parameter		F#	Frequency (MHz)	Min.	Typ.	Max.	Units
Passband	Center Frequency	Fc	—	—	25875	—	MHz
	Insertion Loss	F1-F2	24250 - 27500	—	2.4	3.0	dB
	Return Loss	F1-F2	24250 - 27500	15	18	—	dB
Stop Band, Lower	Rejection	DC-F3	DC - 23875	60	63	—	dB
Stop Band, Upper	Rejection	F4-F5	27875 - 43500	60	63	—	dB
		F5-F6	43500 - 50000	—	60	—	dB

1. Data measured after calibrating using 2.92mm cal kit.

MAXIMUM RATINGS

Parameter	Ratings
Operating temperature	-30°C to +70°C
Storage temperature	-30°C to +70°C
RF Power Input	2.5W max. at 25°C

Permanent damage may occur if any of these limits are exceeded
Input and output ports are DC short to ground.

TYPICAL FREQUENCY RESPONSE

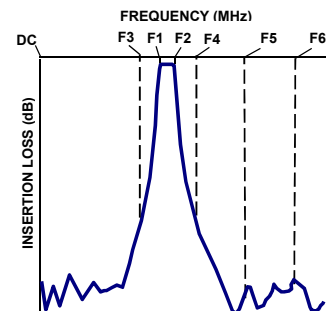

FUNCTIONAL SCHEMATIC

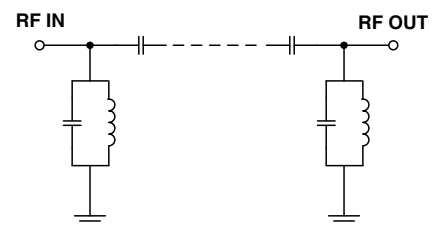



CAVITY

Bandpass Filter

ZVBP-25875-K+

COAXIAL CONNECTIONS

PORT 1	2.92mm-Female
PORT 2	2.92mm-Female

OUTLINE DRAWING

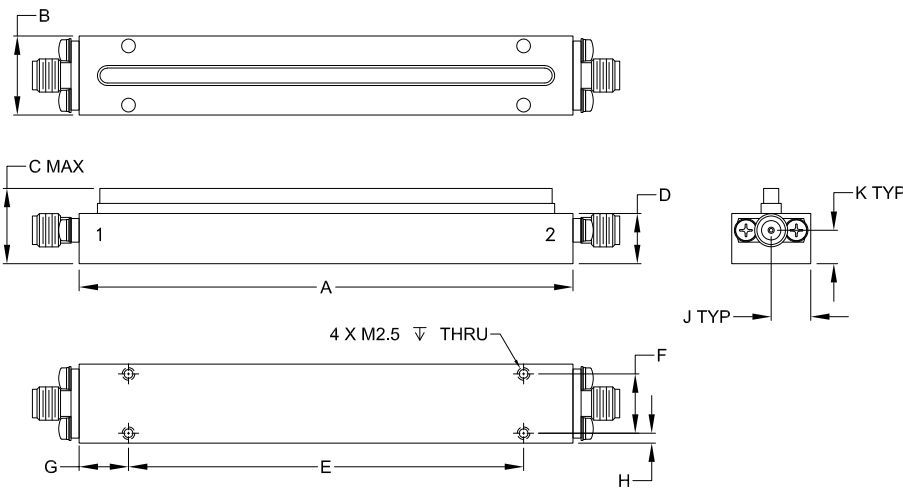

OUTLINE DIMENSIONS (Inches)

A	B	C	D	E	F
3.94	.63	.60	.40	3.150	.472
100.0	16.0	15.2	10.2	80.00	12.00
G	H	J	K	Wt.	
.39	.08	.32	.26	grams	
10.0	2.0	8.0	6.7	122	

Note. Please refer to case style drawing for details



CAVITY

Bandpass Filter

ZVBP-25875-K+

TYPICAL PERFORMANCE DATA AT 25°C

Frequency (MHz)	Insertion Loss (dB)	Return Loss (dB)	Frequency (MHz)	Group Delay (ns)
10	89.05	0.00	24250	4.17
10000	110.61	0.16	24500	2.64
23875	66.55	0.60	24700	2.27
24100	22.35	1.60	24900	2.05
24180	3.81	9.07	25100	1.92
24250	1.72	26.86	25300	1.83
25000	0.94	22.87	25500	1.79
25875	0.93	19.04	25700	1.73
27000	1.14	20.65	25875	1.72
27500	2.05	31.65	26000	1.72
27640	21.25	1.40	26250	1.74
27690	32.92	0.89	26500	1.79
27875	63.93	0.50	26750	1.89
43500	97.60	0.29	27000	2.07
50000	94.58	0.38	27500	4.04

ZVBP-25875-K+
INSERTION LOSS

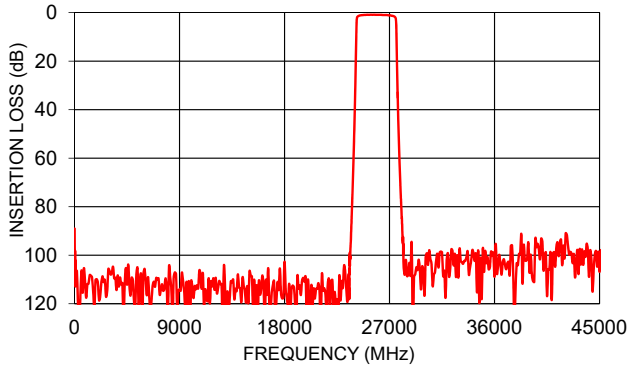

ZVBP-25875-K+
INSERTION LOSS (Zoomed)

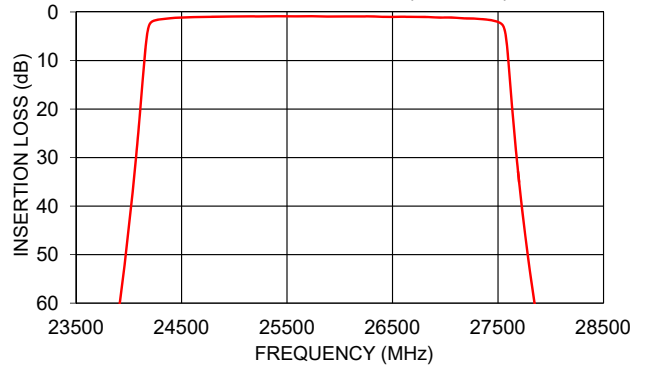

ZVBP-25875-K+
RETURN LOSS

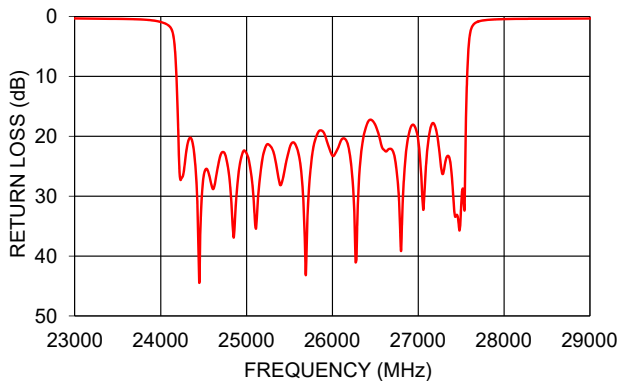

ZVBP-25875-K+
GROUP DELAY

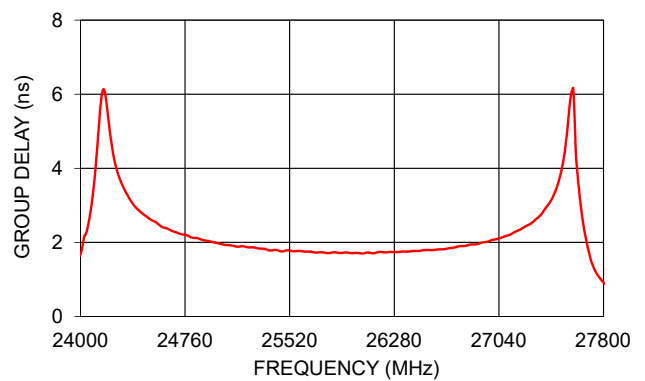

NOTES

- A. Performance and quality attributes and conditions not expressly stated in this specification document are intended to be excluded and do not form a part of this specification document.
- B. Electrical specifications and performance data contained in this specification document are based on Mini-Circuit's applicable established test performance criteria and measurement instructions.
- C. The parts covered by this specification document are subject to Mini-Circuits standard limited warranty and terms and conditions (collectively, "Standard Terms"); Purchasers of this part are entitled to the rights and benefits contained therein. For a full statement of the standard. Terms and the exclusive rights and remedies thereunder, please visit Mini-Circuits' website at www.minicircuits.com/MCLStore/terms.jsp

