

Cavity Bandpass Filters

ZVBP Model Series

50Ω 24.25 to 43.5 GHz

The Big Deal

- Very low insertion loss with excellent power handling
- Sharp roll-off with wide stopband
- Passbands from 24.25 to 43.5 GHz covering 5G bands*.
- Stopbands up to 57 GHz



Product Overview

Mini-Circuits' cavity filters are designed by implementing resonant structures with very high Q and are ideal for narrow-band, high-selectivity applications. These designs can provide bandwidths as narrow as 3% with very high selectivity and excellent low noise floor. Low insertion loss combined with excellent power handling makes them well-suited for transmitter and receiver front end. Advanced filter design and construction enables stopband width greater than 3x the center frequency.

Key Features

Feature	Advantages
5G bands	Use in various 5G applications, covering n257, n258, n259, n260, and n261 bands.
Low insertion loss	Low signal loss results in better SNR in receiver front end and better power delivery to antenna in transmitter
Sharp roll-off	Higher selectivity results in better adjacent channel rejection and dynamic range
Wide stopband	Wide spur free band results in better receiver sensitivity
High power handling	Well suited for transmitter application
Protective assembly	Prevents accidental de-tuning of precisely tuned resonant circuit

*High frequency models operating above 40 GHz are available with 2.4mm connectors.

Cavity Bandpass Filter

50Ω 37700 to 43500 MHz

ZVBP-40600-V+



Generic photo used for illustration purposes only

CASE STYLE: UH3130

Connectors	Model
2.4mm-F	ZVBP-40600-V+

Features

- Low insertion loss, 1.6 dB typical
- Good return loss, 22 dB typical
- High rejection
- Broad stopband performance up to 57 GHz
- Sharp roll-off

Applications

- 5G bands n259 and n260

Electrical Specifications¹ at 25°C

Parameter	F#	Frequency (MHz)	Min.	Typ.	Max.	Unit
Pass Band	Center Frequency	-	-	40600	-	MHz
	Insertion Loss	F1-F2	37700 - 43500	-	1.4	3.0 dB
	Return Loss	F1-F2	37700 - 43500	15	26	- dB
Stop Band, Lower	Insertion Loss	DC-F3	DC - 36600	80	112	- dB
	Return Loss	DC-F3	DC - 36600	-	0.22	- dB
Stop Band, Upper	Insertion Loss	F4-F5	44600 - 57000	80	102	- dB
	Return Loss	F4-F5	44600 - 57000	-	0.98	- dB

1. Data measured after calibrating using 2.4mm cal kit.

Simplified Functional Schematic

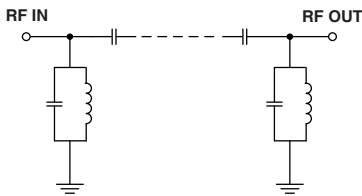

Maximum Ratings	
Operating Temperature	-30°C to 70°C
Storage Temperature	-30°C to 70°C
RF Power Input	2.5 W

Permanent damage may occur if any of these limits are exceeded.

Typical Performance Data at 25°C

Frequency (MHz)	Insertion Loss (dB)	Return Loss (dB)	Frequency (MHz)	Group Delay (nsec)
10	82.5	0.05	37700	2.94
1000	112.9	0.06	38000	1.90
10000	111.9	0.11	38300	1.57
20000	113.1	0.11	38600	1.39
29000	114.6	0.21	38900	1.29
36600	103.2	0.31	39200	1.21
37200	67.6	0.52	39500	1.15
37700	2.69	30.40	39800	1.11
38000	1.76	22.92	40100	1.08
39000	1.25	34.18	40400	1.07
40000	1.16	25.89	40600	1.06
40600	1.15	32.59	40800	1.06
41000	1.16	38.29	41100	1.06
42000	1.29	24.99	41400	1.06
43000	1.66	26.47	41700	1.09
43500	2.61	28.60	42000	1.11
44000	45.7	0.82	42300	1.17
44600	86.6	0.37	42600	1.25
50000	111.7	0.28	42900	1.38
57000	97.3	0.50	43500	2.58

Typical Frequency Response

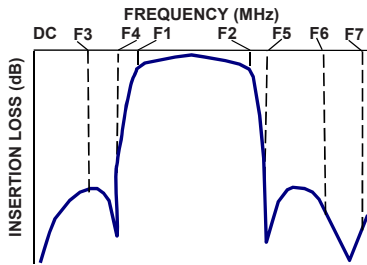

+RoHS Compliant
The +Suffix identifies RoHS Compliance. See our web site for RoHS Compliance methodologies and qualifications

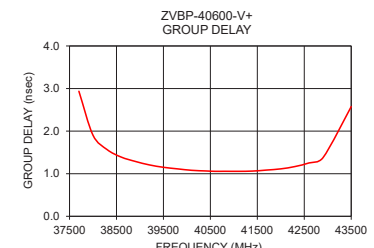
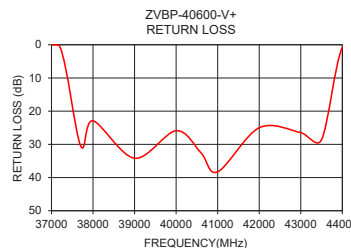
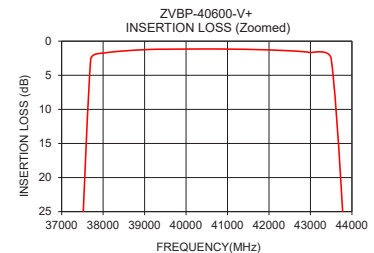
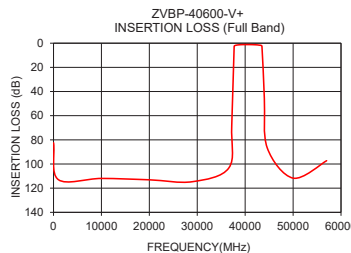

Coaxial Connections

PORT 1	2.4mm-FEMALE
PORT 2	2.4mm-FEMALE

Outline Drawing

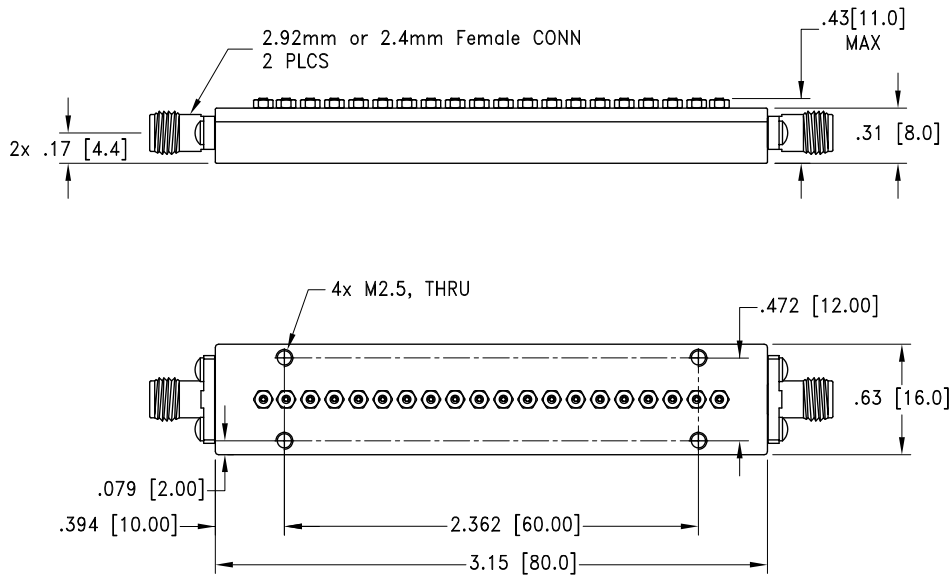

Weight: 77.5 grams \pm 5 grams;
Dimensions are in inches [mm]. Tolerances: 2 Pl. \pm .03; 3 Pl. \pm .015

Additional Notes

- Performance and quality attributes and conditions not expressly stated in this specification document are intended to be excluded and do not form a part of this specification document.
- Electrical specifications and performance data contained in this specification document are based on Mini-Circuit's applicable established test performance criteria and measurement instructions.
- The parts covered by this specification document are subject to Mini-Circuits standard limited warranty and terms and conditions (collectively, "Standard Terms"); Purchasers of this part are entitled to the rights and benefits contained therein. For a full statement of the Standard Terms and the exclusive rights and remedies thereunder, please visit Mini-Circuits' website at www.minicircuits.com/MCLStore/terms.jsp