



CAVITY COAXIAL

Bandpass Filter

ZVBP-V48R5G+

50Ω 47 to 50 GHz 2.4mm Female

KEY FEATURES

- Low Insertion Loss, 0.8dB Typ.
- Good Return Loss, 17dB Typ.
- High Rejection, 80dB Typ.
- Power Handling: 2.5W
- Stopband up to 65GHz



Generic photo used for illustration purposes only

APPLICATIONS

- Telecommunication

PRODUCT OVERVIEW

Mini-Circuits' cavity filters are designed by implementing resonant structures with very high Q and are ideal for narrow-band, high-selectivity applications. These designs can provide bandwidths as narrow as 3% with very high selectivity and excellent low noise floor. Low insertion loss combined with excellent power handling makes them well-suited for transmitter and receiver front end. Advanced filter design and construction enables stopband width greater than 3x the center frequency.

FUNCTIONAL DIAGRAM

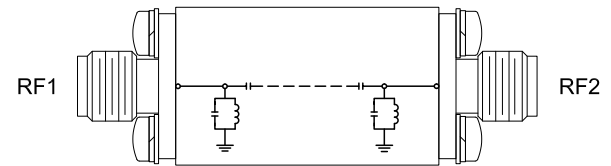

ELECTRICAL SPECIFICATIONS^{1,2} AT +25°C

Parameter		F#	Frequency (GHz)	Min.	Typ.	Max.	Units
Passband	Center Frequency	Fc	—	—	48.5	—	GHz
	1dB Bandwidth	—	—	3	—	—	GHz
	Insertion Loss	Fc	48.5	—	0.8	1.3	dB
	Return Loss	F1-F2	47 - 50	—	17	—	dB
Stop Band, Lower	Rejection	DC-F3	DC - 32	70	80	—	dB
		F3-F4	32 - 40	65	76	—	dB
Stop Band, Upper	Rejection	F5-F6	57 - 65	40	48	—	dB

1. This filter is bi-directional RF1 and RF2 ports may be interchanged, see S-Parameters for actual performance.
2. Data measured after calibrating using 1.85mm cal kit.

ABSOLUTE MAXIMUM RATINGS^{3,4}

Parameter	Ratings
Operating Temperature	-30°C to +70°C
Storage Temperature	-30°C to +70°C
Input Power ⁵	2.5W at 25°C

3. Permanent damage may occur if any of these limits are exceeded.
4. Input and output ports are DC short to ground.
5. Power rating applies only to signals within the passband.

TYPICAL FREQUENCY RESPONSE AT +25°C

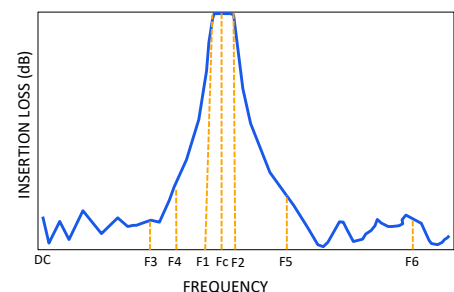



Bandpass Filter

TYPICAL PERFORMANCE GRAPHS

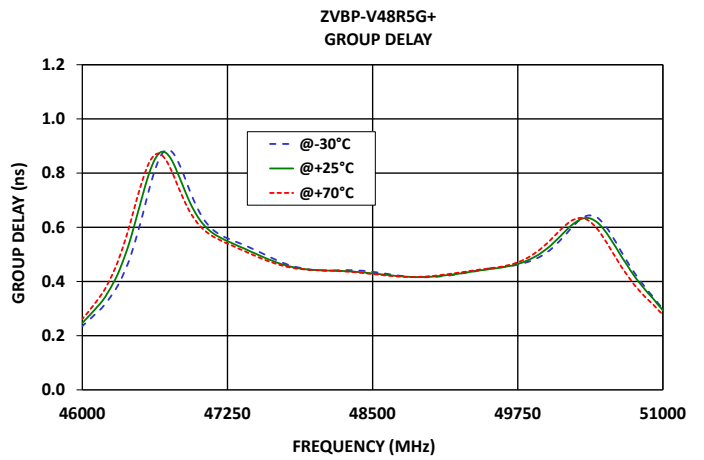
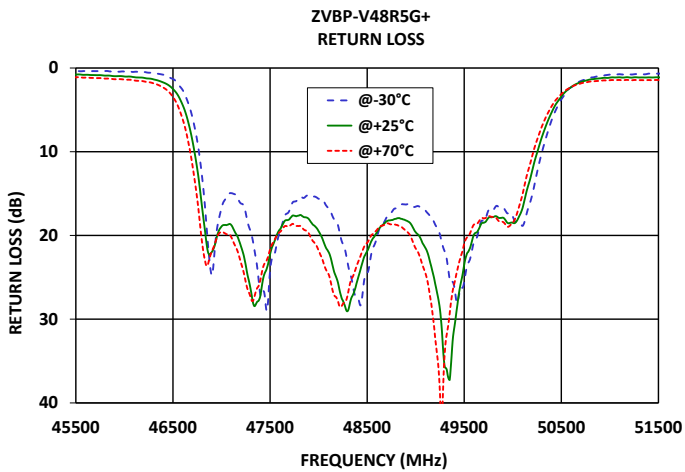
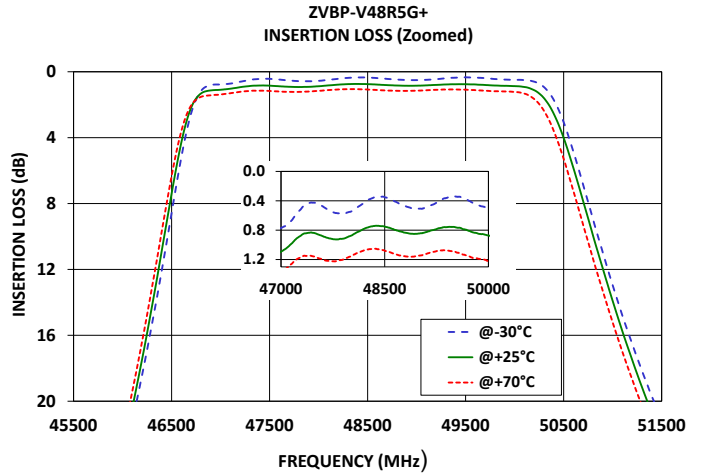
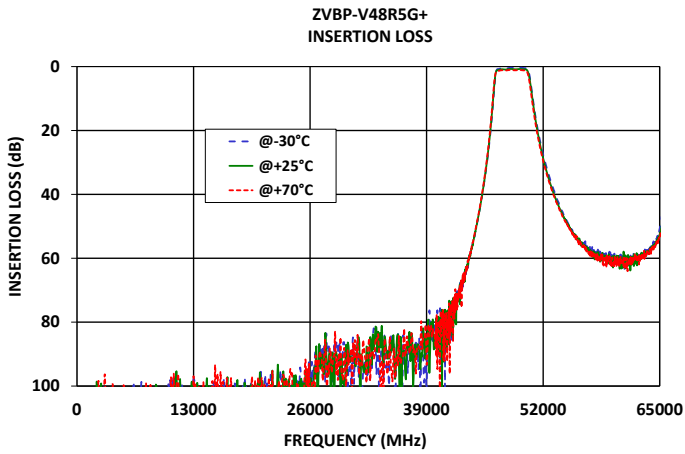



CAVITY COAXIAL

Bandpass Filter

ZVBP-V48R5G+

Mini-Circuits

50Ω 47 to 50 GHz 2.4mm Female

CONNECTOR DESCRIPTION

Function	Marking on Unit	Connector
RF1 ¹	1	2.4mm Female
RF2 ¹	2	2.4mm Female

CASE STYLE DRAWING

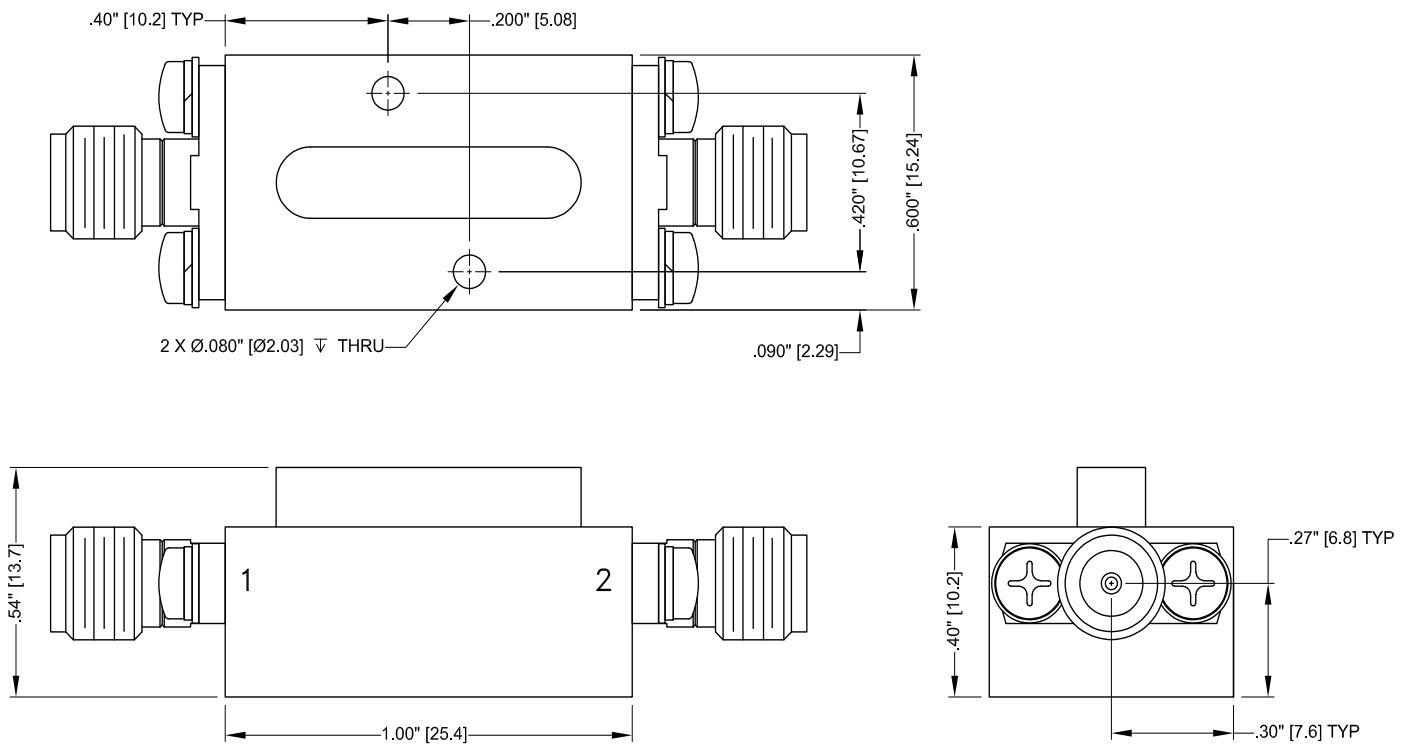

Unit Weight: 36 Grams.

Dimensions are in inches (mm). Tolerances: 2 Pl. ± .100; 3 Pl. ± .015

PRODUCT MARKING*: ZVBP-V48R5G+

*Marking may contain other features or characters for internal lot control.



CAVITY COAXIAL

Bandpass Filter

ZVBP-V48R5G+



50Ω 47 to 50 GHz 2.4mm Female

ADDITIONAL INFORMATION IS AVAILABLE ON OUR DASHBOARD

[CLICK HERE](#)

Performance Data & Graphs	Data Graphs S-Parameter (S2P Files) Data Set (.zip file)
Case Style	ZL3534
RoHS Status	Compliant
Environmental Ratings	ENV001

NOTES

- A. Performance and quality attributes and conditions not expressly stated in this specification document are intended to be excluded and do not form a part of this specification document.
- B. Electrical specifications and performance data contained in this specification document are based on Mini-Circuits' applicable established test performance criteria and measurement instructions.
- C. The parts covered by this specification document are subject to Mini-Circuits' standard limited warranty and terms and conditions (collectively, "Standard Terms"); Purchasers of this part are entitled to the rights and benefits contained therein. For a full statement of the standard terms and the exclusive rights and remedies thereunder, please visit Mini-Circuits' website at www.minicircuits.com/terms/viewterm.html

