

50Ω

0.5 to 15 GHz

## The Big Deal

- Ultra wideband, 0.5 to 15 GHz
- Excellent gain flatness,  $\pm 2.7$  dB
- Low noise figure, 2.4 dB at 8 GHz
- High IP3, up to +28 dBm



Case Style: GC957

## Product Overview

Mini-Circuits' ZX60-153LN+ is an ultra-wideband low noise connectorized amplifier providing a unique combination of low noise figure, high IP3 and flat gain over a very wide frequency range, supporting a wide range of sensitive, high-dynamic range receiver applications and many systems where high performance over wideband is needed. This design operates on a single 12V supply and comes in a rugged, compact unibody case (0.74 x 0.75 x 0.46") with SMA connectors, making it an excellent candidate for tough operating conditions and crowded system layouts.

## Key Features

Feature	Advantages
Ultra-wideband with excellent gain flatness, $\pm 2.7$ dB	Enables a single amplifier to be used in a wide range of applications including WiFi, LTE, S-Band radar, C-band and X-band SatCom, defense, instrumentation and more.
Low noise over the whole band, 2.4 dB typ.	Enables lower system noise figure performance.
High gain, 17 dB typ.	Reduces the number of gain stages, lowering component count and overall system cost.
High IP3, +28 dBm typ.	The combination of low noise and high IP3 makes the ZX60-153LN+ ideal for use in low noise receiver front end (RFE) as it gives the user the advantages of sensitivity and two-tone IM performance at both ends of the dynamic range.
Rugged, unibody construction	Mini-Circuits unibody construction integrates the RF connector into the case body, providing high reliability and excellent survivability in critical applications.

# Coaxial Low Noise Amplifier

## ZX60-153LN+

50Ω 0.5 to 15 GHz

### Features

- Low noise figure, 2.4 dB at 8 GHz
- High IP3, 28 dBm typ. at 8 GHz
- Excellent gain flatness, ± 2.5 dB

### Applications

- WiFi
- WLAN
- UMTS
- LTE
- WiMAX
- X-band Radar
- C-band Satcom



Case Style: GC957

Connectors	Model
SMA	ZX60-153LN-S+

**+RoHS Compliant**

The +Suffix identifies RoHS Compliance. See our web site for RoHS Compliance methodologies and qualifications

### Electrical Specifications at 25°C<sup>1</sup>

Parameter	Condition (MHz)	Min.	Typ.	Max.	Units
Frequency Range		0.5		15	GHz
Noise Figure	0.5		2.6		dB
	2.0		2.1		
	8.0	—	2.4	2.9	
	12.0		3.0		
	15.0		3.7		
Gain	0.5	—	18.6	—	dB
	2.0	—	18.7	—	
	8.0	15.1	16.3	18.4	
	12.0	13.2	15.4	16.5	
	15.0	—	14.3	—	
Input VSWR	0.5		2.5		:1
	2.0		1.7		
	8.0		1.9		
	12.0		2.3		
	15.0		3.5		
Output VSWR	0.5		1.5		:1
	2.0		1.5		
	8.0		1.4		
	12.0		1.5		
	15.0		1.6		
Output Power @ 1 dB compression	0.5		16.0		dBm
	2.0		16.5		
	8.0	14	16.4	—	
	12.0		14.3		
	15.0		13.3		
Output IP3	0.5		29.4		dBm
	2.0		31.2		
	8.0		28.3		
	12.0		27		
	15.0		25.1		
Device Operating Voltage (V <sub>DD</sub> )			12		V
Device Operating Current (I <sub>DD</sub> )		—	82	94	mA
Device Current Variation vs. Temperature <sup>2</sup>			-11.7		μA/°C
Device Current Variation vs. Voltage			0.0187		mA/mV

1. Measured on Mini-Circuits Characterization Test Board TB-MB014. See Characterization Test Circuit (Fig. 1)

2. (Current at 85°C - Current at -45°C)/130

## Absolute Maximum Ratings<sup>4</sup>

Parameter	Ratings
Operating Temperature (ground lead)	-40°C to 85°C
Storage Temperature	-55°C to 100°C
Total Power Dissipation	1.2W
Input Power (CW), Vd=12V	+23 dBm (5 minutes max.) +8 dBm (continuous)
DC Voltage	13V

Permanent damage may occur if any of these limits are exceeded.

4. Permanent damage may occur if any of these limits are exceeded.  
Electrical maximum ratings are not intended for continuous normal operation.

## Outline Drawing

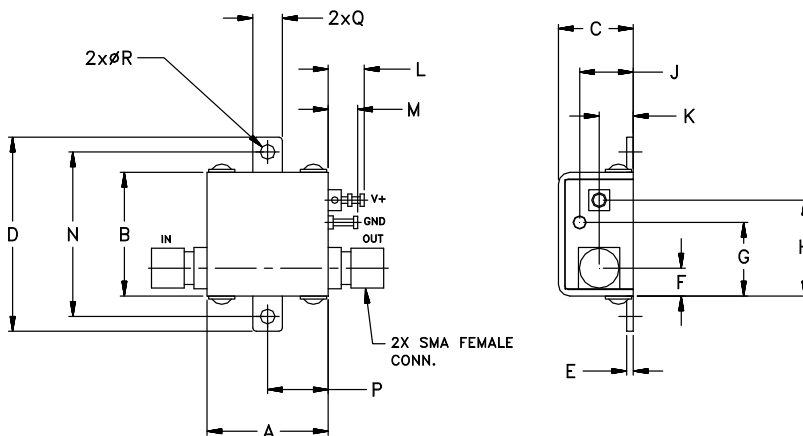

**!** NOTE: When soldering the DC connections, caution must be used to avoid overheating the DC terminal. See Application Note. [AN-40-010](#).

## Outline Dimensions (inch/mm)

A	B	C	D	E	F	G	H	J	K	L	M	N	P	Q	R	wt
.74	.75	.46	1.18	.04	.17	.45	.59	.33	.21	.22	.18	1.00	.37	.18	.106	grams
18.80	19.05	11.68	29.97	1.02	4.32	11.43	14.99	8.38	5.33	5.59	4.57	25.40	9.40	4.57	2.69	23.0

FREQUENCY (MHz)	GAIN (dB)	DIRECTIVITY (dB)	VSWR (:1)		POUT at 1dB COMPR. (dBm)	NOISE FIGURE (dB)	OUTPUT IP3 (dBm)
			IN	OUT			
500	18.55	7.88	2.44	1.47	16.17	2.56	30.73
1000	19.09	6.45	1.70	1.34	16.74	2.15	31.59
1500	18.98	6.53	1.62	1.37	16.76	2.23	31.92
2000	18.69	7.10	1.67	1.43	16.86	2.15	32.58
3000	18.00	8.59	1.84	1.56	17.05	2.31	32.95
4000	17.35	10.23	1.97	1.54	17.18	2.29	32.49
5000	16.92	11.56	2.01	1.35	17.24	2.35	31.31
6000	16.51	13.00	2.00	1.20	17.09	2.29	30.44
7000	16.14	14.37	1.98	1.25	16.73	2.38	29.75
8000	16.33	15.13	1.86	1.20	16.75	2.28	29.11
10000	15.98	18.48	1.67	1.50	15.81	2.57	27.99
11000	16.05	19.47	1.85	1.82	15.10	2.67	27.64
12000	15.58	20.57	2.30	1.65	14.66	2.92	27.26
14000	14.49	21.02	4.15	1.21	13.93	3.43	26.17
15000	14.25	21.94	3.74	1.68	13.99	3.72	26.70

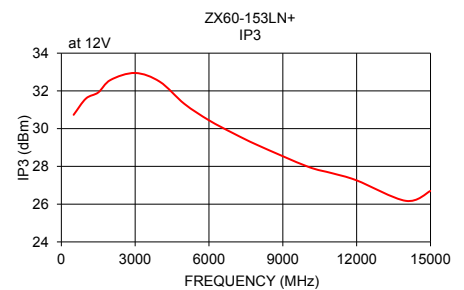
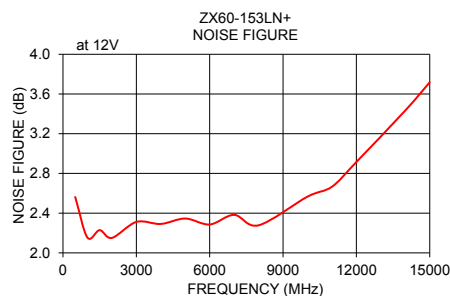
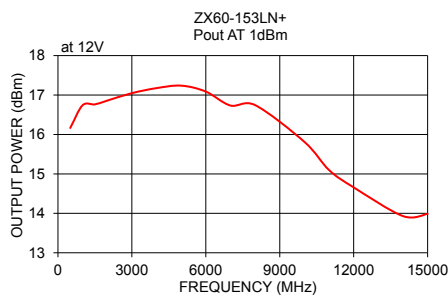
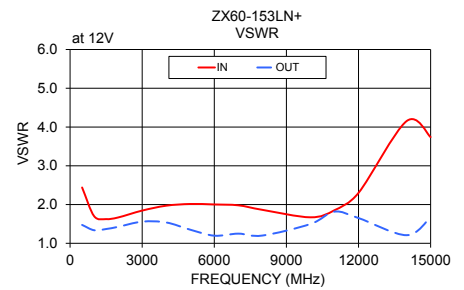
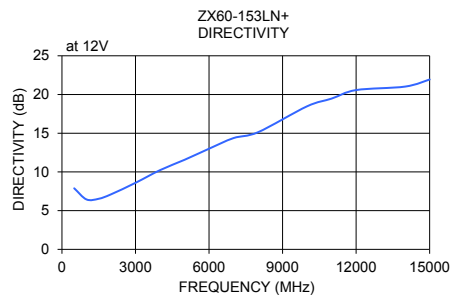
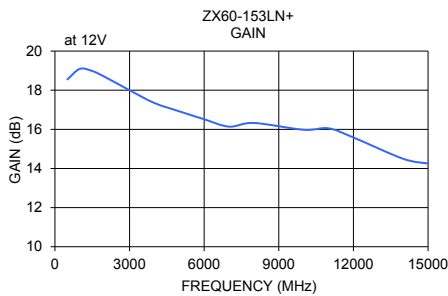

### Additional Notes

- A. Performance and quality attributes and conditions not expressly stated in this specification document are intended to be excluded and do not form a part of this specification document.
- B. Electrical specifications and performance data contained in this specification document are based on Mini-Circuit's applicable established test performance criteria and measurement instructions.
- C. The parts covered by this specification document are subject to Mini-Circuits standard limited warranty and terms and conditions (collectively, "Standard Terms"); Purchasers of this part are entitled to the rights and benefits contained therein. For a full statement of the Standard Terms and the exclusive rights and remedies thereunder, please visit Mini-Circuits' website at [www.minicircuits.com/MCLStore/terms.jsp](http://www.minicircuits.com/MCLStore/terms.jsp)

