

Low Noise Amplifier

ZX60HV-83LN+

50Ω 0.5 to 8 GHz

The Big Deal

- Extremely wideband, 0.5 to 8 GHz
- Low Noise, 1.4 dB at 2 GHz
- High IP3, +35 dBm at 2 GHz
- Excellent gain flatness ± 1.5 dB over 0.5 to 7 GHz @12V



CASE STYLE: GC957

Product Overview

Mini-Circuits' ZX60HV-83LN+ is a wideband low noise connectorized amplifier providing a unique combination of low noise figure, high IP3 and flat gain over a very wide frequency range, supporting a wide range of sensitive, high-dynamic range receiver applications and many systems where high performance over wideband is needed. This design operates on a single 12V supply and comes in a rugged, compact unibody case (0.74 x 0.75 x 0.46") with SMA connectors, making it an excellent candidate for tough operating conditions and crowded system layouts.

Key Features

Feature	Advantages
Ultra-wideband with excellent gain flatness, ± 1.5 dB	Enables a single amplifier to be used in a wide range of applications including WiFi, LTE, S-Band radar, C-band SATCOM, defense, instrumentation and more.
Low noise over the whole band	Enables lower system noise figure performance.
High gain, 21 dB typ.	Reduces the number of gain stages, lowering component count and overall system cost.
High IP3: <ul style="list-style-type: none"> • +35.2 dBm at 2 GHz • +28.5 dBm at 8 GHz 	The combination of low noise and high IP3 makes the ZX60HV-83LN+ ideal for use in low noise receiver front end (RFE) as it gives the user the advantages of sensitivity and two-tone IM performance at both ends of the dynamic range.
Rugged, unibody construction	Mini-Circuits unibody construction integrates the RF connector into the case body, providing high reliability and excellent survivability in critical applications.

Coaxial Low Noise Amplifier

ZX60HV-83LN+

50Ω 0.5 to 8 GHz

Features

- Low Noise figure, 1.4 dB at 2 GHz
- High IP3, 35 dBm typ. at 2 GHz
- High Pout, P1dB 20.7 dBm typ. at 2 GHz
- Excellent Gain flatness, ±1.5 dB over 0.5 to 7 GHz

Applications

- WiFi
- WLAN
- UMTS
- LTE
- WiMAX
- S-band Radar
- C-band Satcom



CASE STYLE: GC957

Connectors	Model
SMA	ZX60HV-83LN-S+

+RoHS Compliant

The +Suffix identifies RoHS Compliance. See our web site for RoHS Compliance methodologies and qualifications

Electrical Specifications at 25°C, unless noted

Parameter	Condition (GHz)	V _{DD} =12.0			Units
		Min.	Typ.	Max.	
Frequency Range		0.5		8.0	GHz
Noise Figure	0.5	—	1.6	—	dB
	2.0	—	1.4	1.7	
	4.0	—	1.5	—	
	8.0	—	2.3	—	
Gain	0.5	—	22.1	—	dB
	2.0	19.9	22.1	24.3	
	4.0	—	21.5	—	
	8.0	—	18.0	—	
Input Return Loss	0.5		13.0		dB
	2.0		15.0		
	4.0		11.0		
	8.0		5.0		
Output Return Loss	0.5		13.0		dB
	2.0		14.0		
	4.0		18.0		
	8.0		10.0		
Output Power at 1dB Compression ¹	0.5		12.8		dBm
	2.0		20.7		
	4.0		18.3		
	8.0		17.2		
Output IP3	0.5		31.5		dBm
	2.0		35.2		
	4.0		31.0		
	8.0		28.5		
Device Operating Voltage (V _{DD})		—	12	—	V
Device Operating Current (I _{DD})		—	77	94	mA

1. Current increases at P1dB to 109 mA typ.

Absolute Maximum Ratings²

Parameter	Ratings
Operating Temperature (ground lead)	-40°C to 85°C
Storage Temperature	-55°C to 100°C
Total Power Dissipation	1.5 W
Input Power (CW), Vd=5.6V	+19 dBm (5 minutes max.) +16 dBm (continuous)
DC Voltage	13 V

2. Permanent damage may occur if any of these limits are exceeded.
Electrical maximum ratings are not intended for continuous normal operation.

Outline Drawing

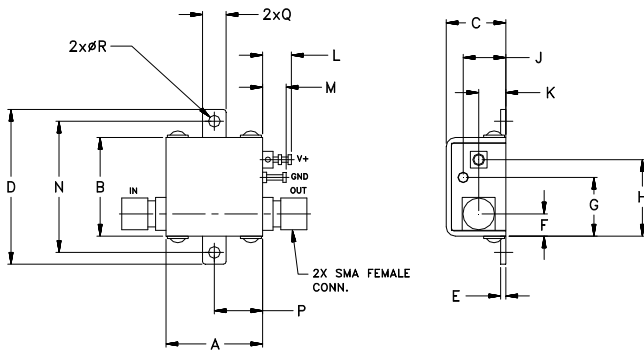

! NOTE: When soldering the DC connections, caution must be used to avoid overheating the DC terminal. See Application Note. [AN-40-010](#).

Outline Dimensions (inch/mm)

A	B	C	D	E	F	G	H	J	K	L	M	N	P	Q	R	wt
.74	.75	.46	1.18	.04	.17	.45	.59	.33	.21	.22	.18	1.00	.37	.18	.106	grams
18.80	19.05	11.68	29.97	1.02	4.32	11.43	14.99	8.38	5.33	5.59	4.57	25.40	9.40	4.57	2.69	23.0

FREQUENCY (MHz)	GAIN (dB)	DIRECTIVITY (dB)	VSWR (:1)		POWER OUT @1 dB COMPR. (dBm)	NF (dB)	IP3 (dBm)
	12V	12V	IN	OUT	12V	12V	12V
500	22.09	27.51	1.60	1.56	17.80	1.63	31.37
1000	22.61	26.83	1.15	1.58	19.96	1.33	32.12
1500	22.46	26.89	1.32	1.71	20.86	1.39	36.20
2000	22.24	27.02	1.42	1.72	20.76	1.44	37.47
2500	22.00	27.19	1.47	1.62	20.49	1.50	38.48
3000	21.70	27.42	1.49	1.41	19.64	1.57	33.01
3500	21.59	27.48	1.63	1.22	19.36	1.48	34.41
4000	21.36	27.68	1.79	1.15	18.31	1.56	31.88
4500	21.11	27.93	1.95	1.28	18.70	1.58	32.03
5000	20.89	28.16	2.05	1.43	18.86	1.55	30.90
5500	20.79	28.28	2.07	1.55	19.40	1.57	31.35
6000	20.79	28.27	2.00	1.59	19.37	1.61	31.68
6500	20.73	28.28	1.92	1.57	19.22	1.62	32.48
7000	20.20	28.64	1.90	1.64	18.44	1.77	31.92
8000	18.67	29.31	3.17	1.64	17.31	2.26	29.47

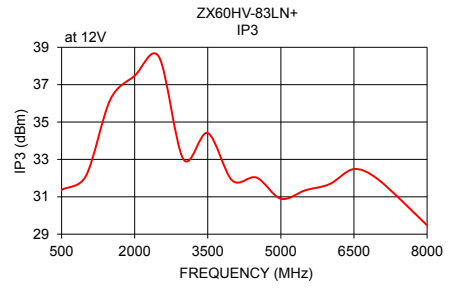
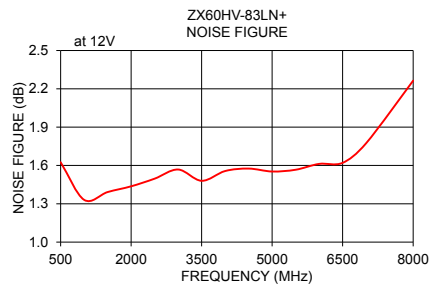
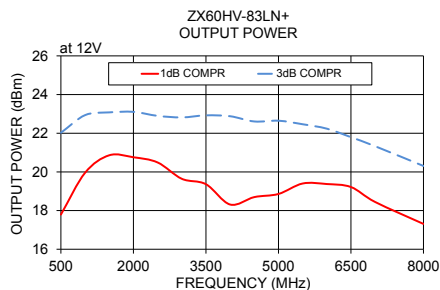
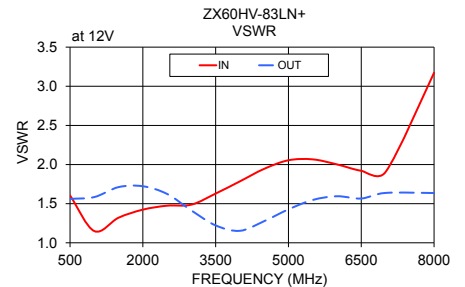
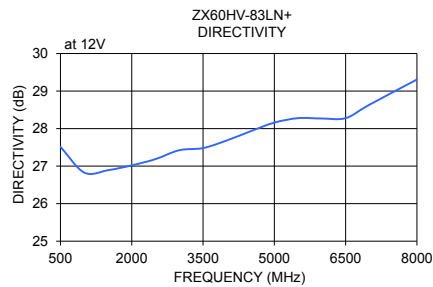
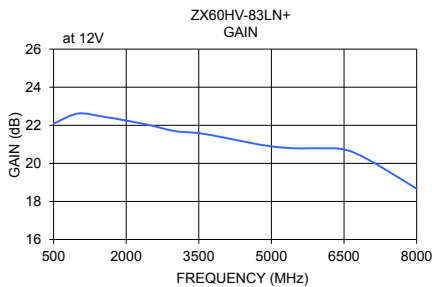

Additional Notes

- A. Performance and quality attributes and conditions not expressly stated in this specification document are intended to be excluded and do not form a part of this specification document.
- B. Electrical specifications and performance data contained in this specification document are based on Mini-Circuit's applicable established test performance criteria and measurement instructions.
- C. The parts covered by this specification document are subject to Mini-Circuits standard limited warranty and terms and conditions (collectively, "Standard Terms"); Purchasers of this part are entitled to the rights and benefits contained therein. For a full statement of the Standard Terms and the exclusive rights and remedies thereunder, please visit Mini-Circuits' website at www.minicircuits.com/MCLStore/terms.jsp