

# Coaxial Bandpass Filter

## ZX75BP-1205+

50Ω 1155 to 1255 MHz

### The Big Deal

- Fast roll-off on the upper sideband
- Good Matching and low loss in the pass band
- Connectorized package



CASE STYLE: HY1238

### Product Overview

ZX75BP-1205+ is a ceramic resonator based co-axial bandpass filter in a rugged connectorized package covering 1155 to 1255 MHz. This filter offers good rejection low insertion loss and high power handling for use in transmitter and receiver RF chains.

### Key Features

Feature	Advantages
Fast roll-off on the upper side band	This filter has fast-roll off on the upper side band, which increases selectivity on the adjacent channel.
Good matching and low loss in pass band	This filter has good matching and low loss in the pass band
Connectorized package	Connectorized package is easy to interface with other devices and well suited for test setups.

#### Notes

- A. Performance and quality attributes and conditions not expressly stated in this specification document are intended to be excluded and do not form a part of this specification document.  
B. Electrical specifications and performance data contained in this specification document are based on Mini-Circuit's applicable established test performance criteria and measurement instructions.  
C. The parts covered by this specification document are subject to Mini-Circuits standard limited warranty and terms and conditions (collectively, "Standard Terms"); Purchasers of this part are entitled to the rights and benefits contained therein. For a full statement of the Standard Terms and the exclusive rights and remedies thereunder, please visit Mini-Circuits' website at [www.minicircuits.com/MCLStore/terms.jsp](http://www.minicircuits.com/MCLStore/terms.jsp)



# Bandpass Filter

## ZX75BP-1205+

50Ω 1155 to 1255 MHz



CASE STYLE: HY1238  
 Connectors Model  
 SMA-MF ZX75BP-1205-S+

### Features

- Fast roll-off on the upper side band
- Good matching in the pass band
- Connectorized package

### Applications

- GPS
- Radar systems
- Navigation systems

### Electrical Specifications at 25°C

Parameter	F#	Frequency (MHz)	Min.	Typ.	Max.	Unit	
Pass Band	Center Frequency	-	-	1205	-	MHz	
	Insertion Loss	F1-F2	1155-1255	-	1.2	2.5	dB
	VSWR	F1-F2	1155-1255	-	1.4	1.92	:1
Stop Band, Lower	Insertion Loss	DC-F3	DC - 1026	20	30.9	-	dB
	VSWR	DC-F3	DC - 1026	-	20	-	:1
Stop Band, Upper	Insertion Loss	F4-F5	1435-4500	20	28.6	-	dB
	VSWR	F4-F5	1435-4500	-	20	-	:1

### Maximum Ratings

Operating Temperature	-40°C to 85°C
Storage Temperature	-55°C to 100°C
RF Power Input	10 W max.

Permanent damage may occur if any of these limits are exceeded.

### Functional Schematic

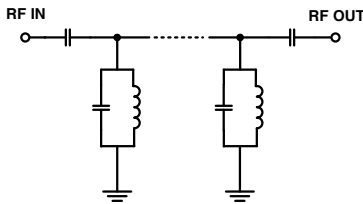

### Typical Frequency Response

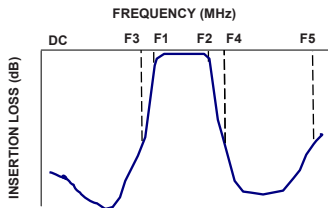

### Typical Performance Data at 25°C

Frequency (MHz)	Insertion Loss (dB)	VSWR (:1)	Frequency (MHz)	Group Delay (nsec)
1.0	115.68	1737.18	1155.0	5.86
100.0	103.22	1737.18	1160.0	5.71
250.0	87.96	868.59	1165.0	5.58
500.0	70.11	347.44	1170.0	5.46
1020.0	33.67	57.91	1180.0	5.26
1026.0	31.76	54.29	1190.0	5.13
1030.0	30.46	52.65	1200.0	5.05
1060.0	20.14	32.79	1201.0	5.04
1105.0	3.10	2.86	1202.0	5.03
1155.0	0.97	1.11	1203.0	5.03
1205.0	0.88	1.05	1204.0	5.02
1255.0	0.97	1.25	1205.0	5.02
1300.0	3.16	3.54	1206.0	5.02
1379.0	20.09	56.04	1207.0	5.02
1435.0	28.80	78.97	1210.0	5.01
1445.0	30.15	82.73	1215.0	5.00
2000.0	44.72	69.49	1225.0	4.99
3000.0	49.13	3.29	1235.0	5.01
3750.0	36.91	11.17	1245.0	5.07
4500.0	62.82	43.44	1255.0	5.28

### +RoHS Compliant

The +Suffix identifies RoHS Compliance. See our web site for RoHS Compliance methodologies and qualifications

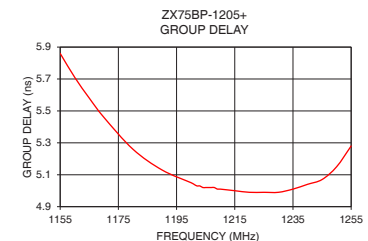
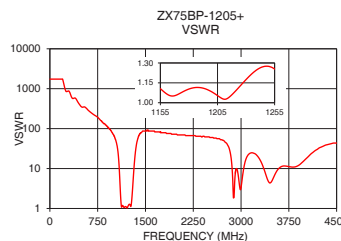
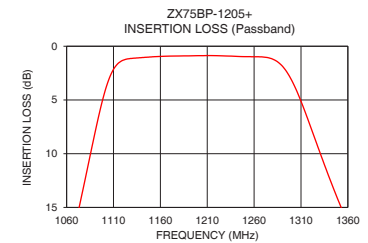
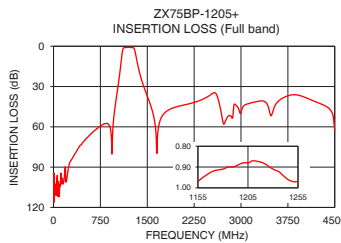

### Notes

- Performance and quality attributes and conditions not expressly stated in this specification document are intended to be excluded and do not form a part of this specification document.
- Electrical specifications and performance data contained in this specification document are based on Mini-Circuits' applicable established test performance criteria and measurement instructions.
- The parts covered by this specification document are subject to Mini-Circuits standard limited warranty and terms and conditions (collectively, "Standard Terms"); Purchasers of this part are entitled to the rights and benefits contained therein. For a full statement of the Standard Terms and the exclusive rights and remedies thereunder, please visit Mini-Circuits' website at [www.minicircuits.com/MCLStore/terms.jsp](http://www.minicircuits.com/MCLStore/terms.jsp)



## Coaxial Connections

INPUT	SMA-MALE
OUTPUT	SMA-FEMALE

## Outline Drawing

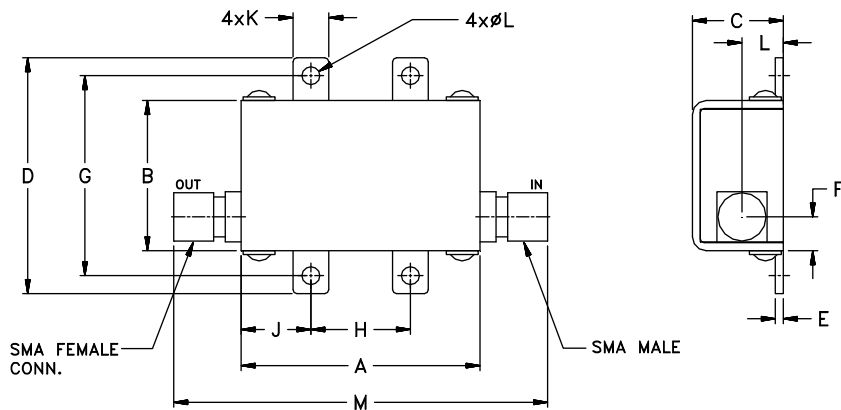

## Outline Dimensions ( $\frac{\text{inch}}{\text{mm}}$ )

A	B	C	D	E	F	G
1.20	.75	.46	1.18	.04	.17	1.00
30.48	19.05	11.68	29.97	1.02	4.32	25.40
H	J	K	L	M	wt	
.50	.35	.18	.106	2.05	grams	
12.70	8.89	4.57	2.69	52.07	35.00	

### Notes

- A. Performance and quality attributes and conditions not expressly stated in this specification document are intended to be excluded and do not form a part of this specification document.  
 B. Electrical specifications and performance data contained in this specification document are based on Mini-Circuit's applicable established test performance criteria and measurement instructions.  
 C. The parts covered by this specification document are subject to Mini-Circuits standard limited warranty and terms and conditions (collectively, "Standard Terms"); Purchasers of this part are entitled to the rights and benefits contained therein. For a full statement of the Standard Terms and the exclusive rights and remedies thereunder, please visit Mini-Circuits' website at [www.minicircuits.com/MCLStore/terms.jsp](http://www.minicircuits.com/MCLStore/terms.jsp)

