

Wide band

Digital Step Attenuator

ZX76-15R5A+ Series

50Ω 0 to 15.5 dB, 0.5 dB Step DC to 4.0 GHz

The Big Deal

- Wideband, operates up to 4 GHz
- Immune to latchup
- High IP3, 52 dBm
- Control inputs buffered by Schmitt Triggers



Generic photo used for illustration purposes only
CASE STYLE: HK1149

Product Overview

The ZX76-15R5A+ series of 50Ω digital step attenuators adjustable attenuation from 0 to 15.5 dB in 0.5 dB steps. The control is a 5-bit serial/parallel interface, and the attenuators operate with either single positive or dual (positive and negative) supply voltage. Control lines are buffered by Schmitt Triggers to allow a wide range of control voltage levels. The ZX76-15R5A+ series is produced using a unique unibody case package for ruggedness and operation in tough environments.

Key Features

Feature	Advantages
Wideband operation, specified from DC to 4.0 GHz	Can be used in multiple applications such as communications, satellite and defense, reducing part count.
Serial interface (Model suffixes: -SNS+ and -SPS+) or parallel interface (Model suffixes: -PNS+ and -PPS+)	Models available with serial or parallel interface mode to suit customer demand.
Good VSWR, 1.3:1 typ.	Eases interfacing with adjacent components and results in low amplitude ripple.
Single positive supply models: (Model suffixes: -SPS+ and -PPS+) +2.3 to +3.6 V	Use of single positive supply simplifies power supply design. An internal negative voltage generator supplies the desired negative voltage. Single positive supply results in excellent spurious performance, -140 dBm typical.
Dual supply models: (Model suffixes: -SNS+ and -PNS+) +2.7 to +3.6 V (Positive) and -3.6 to -3.2 V (Negative)	Dual supply provides spurious-free operation. It also allows fast switching up to 1 MHz (vs. 25 kHz for single supply).
Replaces ZX76-15R5-XX-S+ series (XX=SN/SP/PN/PP)	Same case and pinout and provides improved performance



Digital Step Attenuator

50Ω DC-4000 MHz

15.5 dB, 0.5 dB Step

5 Bit, Serial control interface, Dual Supply Voltage

Product Features

- Low Insertion Loss
- High IP3, +52 dBm Typ
- Excellent return loss, 20 dB Typ
- Excellent accuracy, 0.1 dB Typ
- Fast switching control frequency, 1 MHz typ.
- Dual Supply Voltage: $V_{DD}=+3V$, $V_{SS}=-3.3V$
- Control inputs buffered by Schmitt Triggers
- Rigid unibody case
- Protected by US patent 6,790,049



Generic photo used for illustration purposes only
CASE STYLE: HK1149

ZX76-15R5A-SNS+

Typical Applications

- Lab
- Instrumentation
- Test equipment

Connectors	Order P/N
SMA	ZX76-15R5A-SNS+

+RoHS Compliant

The +Suffix identifies RoHS Compliance. See our web site for RoHS Compliance methodologies and qualifications

General Description

The ZX76-15R5A-SNS+ is a 50Ω digital step attenuator provides adjustable attenuation of 0 to 15.5 dB in 0.5 dB steps. The control is a 5-bit serial interface, and the attenuators operate with dual (positive and negative) supply voltage. The ZX76-15R5A-SNS+ is produced using a unique case package for ruggedness and operation in tough environments.

Simplified Schematic

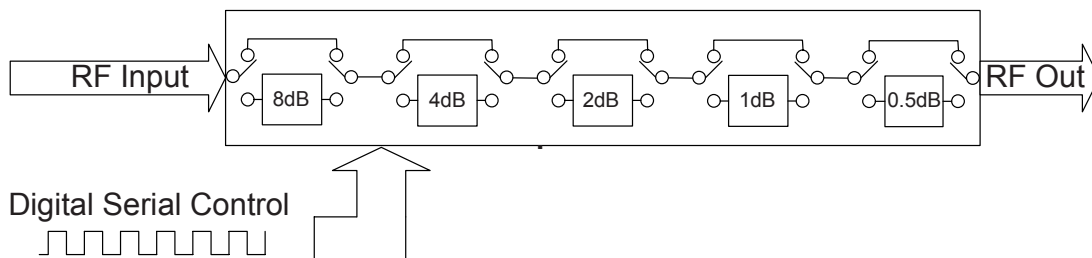

RF Electrical Specifications ^(Note1), DC-4000 MHz, T_{AMB}=25°C, V_{DD}=+3V, V_{SS}=-3.3V

Parameter	Freq. Range (GHz)	Min.	Typ.	Max.	Units
Accuracy @ 0.5 dB Attenuation Setting	DC-1	—	±0.03	±0.10	dB
	1-2.4	—	±0.05	±0.15	
	2.4-4	—	±0.07	±0.20	
Accuracy @ 1 dB Attenuation Setting	DC-1	—	±0.02	±0.10	dB
	1-2.4	—	±0.05	±0.15	
	2.4-4	—	±0.10	±0.25	
Accuracy @ 2 dB Attenuation Setting	DC-1	—	±0.05	±0.15	dB
	1-2.4	—	±0.15	±0.25	
	2.4-4	—	±0.15	±0.35	
Accuracy @ 4 dB Attenuation Setting	DC-1	—	±0.07	±0.25	dB
	1-2.4	—	±0.15	±0.25	
	2.4-4	—	±0.23	±0.50	
Accuracy @ 8 dB Attenuation Setting	DC-1	—	±0.03	±0.20	dB
	1-2.4	—	±0.15	±0.50	
	2.4-4	—	±0.60	±0.80	
Insertion Loss @ all attenuator set to 0dB	DC-1	—	1.4	2.0	dB
	1-2.4	—	1.9	2.7	
	2.4-4	—	2.5	3.3	
Input IP3 ^(note 1) (at Min. and Max. Attenuation)	DC-4	—	+52	—	dBm
Input Power @ 0.2dB Compression ^(note 1) (at Min. and Max. Attenuation)	DC-4	—	+24	—	dBm
Input Operating Power	10 kHz to 50 MHz	—	—	See Fig. 1	dBm
	>50 MHz	—	—	+24	
VSWR	DC-1	—	1.2	1.6	:1
	1-2.4	—	1.3	1.7	
	2.4-4	—	1.45	1.9	

Notes:

1. Input IP3 and 1dB compression degrade below 1 MHz. Input power not to exceed max operating specification for continuous operation.

DC Electrical Specifications

Parameter	Min.	Typ.	Max.	Units
V _{DD} , Supply Voltage	2.7	3	3.6	V
V _{SS} , Supply Voltage	-3.6	-3.3	-3.2	V
I _{DD} Supply Current	—	—	200	µA
I _{SS} Supply Current	—	16	40	µA
Control Input Low	-0.3	—	0.3xV _{DD}	V
Control Input High	0.7xV _{DD}	—	5	V
Control Current	—	—	400	µA

Absolute Maximum Ratings ^(Note 2,3)

Parameter	Ratings
Operating Temperature	-40°C to 85°C
Storage Temperature	-40°C to 85°C
V _{DD}	-0.3V Min., 5.5V Max.
V _{SS}	-3.6V Min., 0.3V Max.
Voltage on any control input	-0.3V Min., 6V Max.
ESD, HBM	500V
ESD, MM	100V
Input Power	+30dBm

2. Permanent damage may occur if any of these limits are exceeded.

3. Operation between max operating and absolute max input power will result in reduced reliability.

Switching Specifications

Parameter	Min.	Typ.	Max.	Units
Switching Speed, 50% Control to 0.5dB of Attenuation Value	—	1.0	—	µSec
Switching Control Frequency	—	1.0	—	MHz

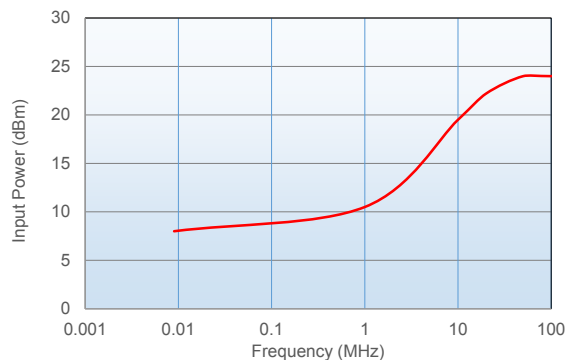

Figure 1. Max Input Operating Power vs Frequency

Pin Description

Function	Pin Number	Description
N/C	J1-1	Not Connected
GND	J1-2	Ground connection
LE	J1-3	Latch Enable Input
N/C	J1-4	Not Connected
GND	J1-5	Ground connection
N/C	J1-6	Not Connected
Clock	J1-7	Serial Interface clock Input
GND	J1-8	Ground connection
Data	J1-9	Serial Interface data Input
N/C	J1-10	Not Connected
RF in	J2	RF in port (Note 1)
RF out	J3	RF out port (Note 1)
GND	P1	Ground connection
V _{DD}	P2	Positive Supply Voltage
GND	P3	Ground connection
V _{SS}	P4	Negative Supply Voltage

Note 1: Both RF ports must be held at 0VDC or DC blocked with an external series capacitor.

Pin Configuration

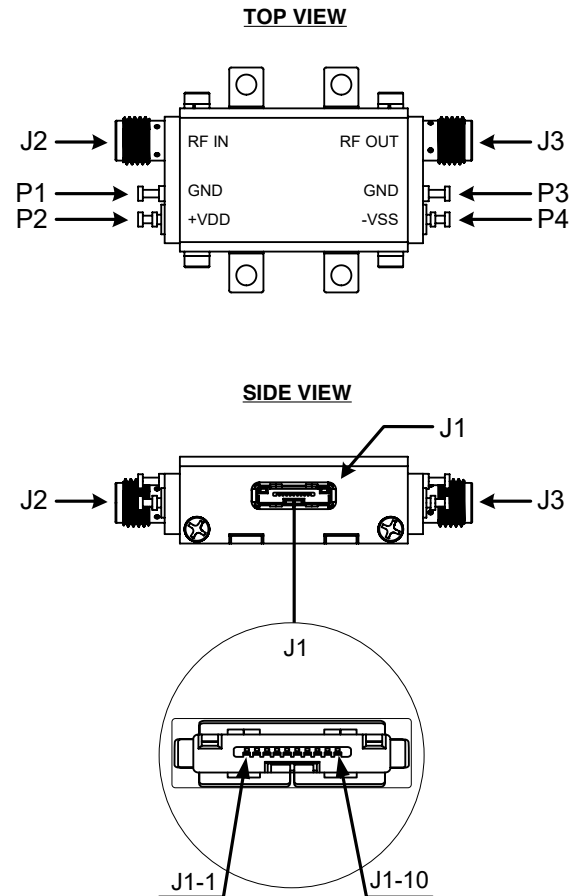

Cable Pin Description

J1-Pin Number	J4-Pin Number	Function	Description	Wire Color
J1-2	J4-18	GND	Ground connection	BLACK
J1-3	J4-4	LE	Latch Enable Input	GREEN
J1-5	J4-19	GND	Ground connection	BLUE
J1-7	J4-2	Clock	Serial Interface clock Input	RED
J1-8	J4-20	GND	Ground connection	ORANGE
J1-9	J4-3	Data	Serial Interface data Input	WHITE

Note: Other pins not connected. Cable shield connected to case ground.

Simplified Schematic

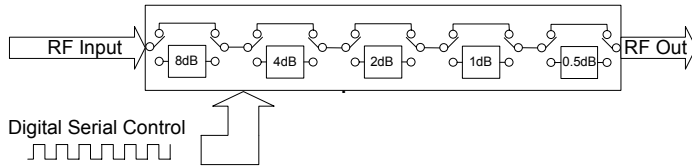

The ZX76-15R5A-SNS+ serial interface consists of 5 control bits that select the desired attenuation state, as shown in Table 1: Truth Table

Attenuation State	C8	C4	C2	C1	C0.5
Reference	0	0	0	0	0
0.5 (dB)	0	0	0	0	1
1 (dB)	0	0	0	1	0
2 (dB)	0	0	1	0	0
4 (dB)	0	1	0	0	0
8 (dB)	1	0	0	0	0
15.5 (dB)	1	1	1	1	1

Note: Not all 32 possible combinations of C0.5 - C8 are shown in table

The serial interface is a 6-bit serial in, parallel-out shift register buffered by a transparent latch with the first five bits being the control bits, and the last bit '0'.

It is controlled by three CMOS-compatible signals: Data, Clock, and Latch Enable (LE). The Data and Clock inputs allow data to be serially entered into the shift register, a process that is independent of the state of the LE input. The shift register triggers on the rising edge of the clock signal.

The LE input controls the latch. When LE is HIGH, the latch is transparent and the contents of the serial shift register control the attenuator. When LE is brought LOW, data in the shift register is latched.

The shift register should be loaded while LE is held LOW to prevent the attenuator value from changing as data is entered. The LE input should then be toggled HIGH and brought LOW again, latching the new data. The timing for this operation is defined by **Figure 2** (Serial Interface Timing Diagram) and **Table 2** (Serial Interface AC Characteristics).

Figure 2: Serial interface Timing Diagram

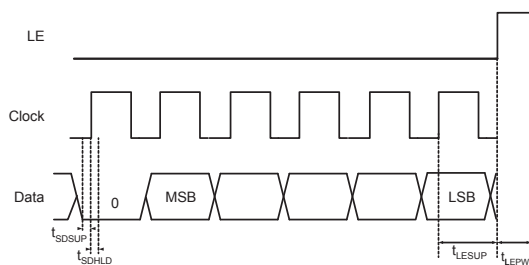

Table 2. Serial Interface AC Characteristics

Symbol	Parameter	Min.	Max.	Units
f_{clk}	Serial data clock frequency (Note 1)		10	MHz
t_{clkH}	Serial clock HIGH time	30		ns
t_{clkL}	Serial clock LOW time	30		ns
t_{LESUP}	LE set-up time after last clock rising edge	10		ns
t_{LEPW}	LE minimum pulse width	30		ns
t_{SDSUP}	Serial data set-up rising edge	10		ns
t_{SDHLD}	Serial data hold time after clock rising edge	10		ns

Note 1. f_{clk} verified during the functional pattern test. Serial programming sections of the functional pattern are clocked at 10MHz to verify f_{clk} specification.

Recommended Accessories

Two optional cable accessories with and without interface connector are available with ZX76-15R5A-SNS+, the ZX76-CS+ and ZX76-WS+. Cable length is 4.9 feet / 1.5 meters.

ZX76-CS+ shielded cable with interface 25 pin D-type connector J4 and supplied software are used to control the ZX76-15R5A-SNS+ digital attenuator from a computer, using LPT port.

ZX76-WS+ shielded cable without interface 25 pin D-type connector enables customer to use the ZX76-15R5A-SNS+ digital attenuator in his own application.

ZX76-CS+ Control Cable

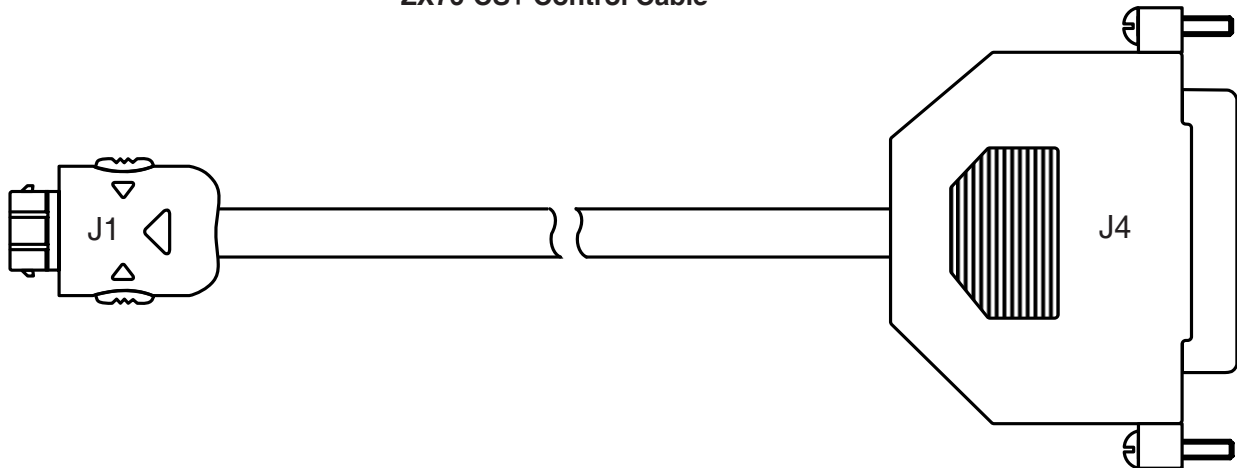

ZX76-CS+ wiring information

J1-Pin Number	J4-Pin Number	Function	Description	Wire Color
J1-2	J4-18	GND	Ground connection	BLACK
J1-3	J4-4	LE	Latch Enable Input	GREEN
J1-5	J4-19	GND	Ground connection	BLUE
J1-7	J4-2	Clock	Serial Interface clock Input	RED
J1-8	J4-20	GND	Ground connection	ORANGE
J1-9	J4-3	Data	Serial Interface data Input	WHITE

Note: Other pins not connected. Cable shield connected to case ground.

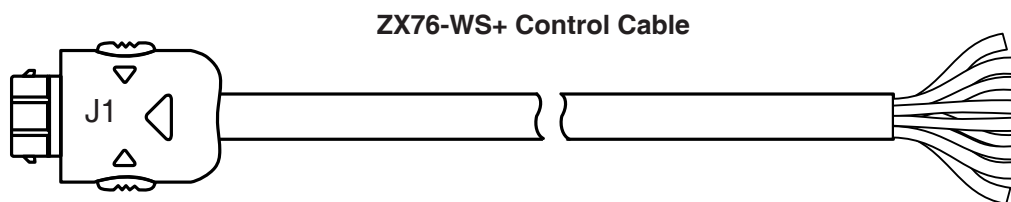

ZX76-WS+ wiring information

J1-Pin Number	Function	Description	Wire Color
J1-2	GND	Ground connection	BLACK
J1-3	LE	Latch Enable Input	GREEN
J1-5	GND	Ground connection	BLUE
J1-7	Clock	Serial Interface clock Input	RED
J1-8	GND	Ground connection	ORANGE
J1-9	Data	Serial Interface data Input	WHITE

Note: Other pins not connected. Cable shield connected to case ground.

Ordering Information

Model Number	Description
ZX76-15R5A-SNS+	Digital attenuator - Serial interface Dual Voltage (Negative and Positive)
ZX76-CS+	Cable accessory with interface connector
ZX76-WS+	Cable accessory without interface connector

Additional Detailed Technical Information

additional information is available on our dash board. To access this information [click here](#)

Performance Data	Data Table
	Swept Graphs
	S-Parameter (S2P Files) Data Set (.zip file)
Case Style	HK1149
Environmental Ratings	ENV28T14

Additional Notes

- Performance and quality attributes and conditions not expressly stated in this specification document are intended to be excluded and do not form a part of this specification document.
- Electrical specifications and performance data contained in this specification document are based on Mini-Circuits' applicable established test performance criteria and measurement instructions.
- The parts covered by this specification document are subject to Mini-Circuits standard limited warranty and terms and conditions (collectively, "Standard Terms"); Purchasers of this part are entitled to the rights and benefits contained therein. For a full statement of the Standard Terms and the exclusive rights and remedies thereunder, please visit Mini-Circuits' website at www.minicircuits.com/MCLStore/terms.jsp

