

Wide band Digital Step Attenuator

ZX76-31A+ Series

50Ω 0 to 31 dB, 1 dB Step DC to 4.0 GHz

The Big Deal

- Wideband, operates up to 4 GHz
- Immune to latchup
- High IP3, 52 dBm
- Control inputs buffered by Schmitt Triggers



Generic photo used for illustration purposes only
CASE STYLE: HK1149

Product Overview

The ZX76-31A+ series of 50Ω digital step attenuators adjustable attenuation from 0 to 31 dB in 1 dB steps. The control is a 5-bit serial/parallel interface, and the attenuators operate with either single positive or dual (positive and negative) supply voltage. Control lines are buffered by Schmitt Triggers to allow a wide range of control voltage levels. The ZX76-31A+ series is produced using a unique unibody case package for ruggedness and operation in tough environments.

Key Features

| Feature | Advantages |
|--|---|
| Wideband operation, specified from DC to 4.0 GHz | Can be used in multiple applications such as communications, satellite and defense, reducing part count. |
| Serial interface (Model suffixes: -SNS+ and -SPS+) or parallel interface (Model suffixes: -PNS+ and -PPS+) | Models available with serial or parallel interface mode to suit customer demand. |
| Good VSWR, 1.3:1 typ. | Eases interfacing with adjacent components and results in low amplitude ripple. |
| Single positive supply models: (Model suffixes: -SPS+ and -PPS+) +2.3 to +3.6 V | Use of single positive supply simplifies power supply design. An internal negative voltage generator supplies the desired negative voltage. Single positive supply results in excellent spurious performance, -140 dBm typical. |
| Dual supply models: (Model suffixes: -SNS+ and -PNS+) +2.7 to +3.6 V (Positive) and -3.6 to -3.2 V (Negative) | Dual supply provides spurious-free operation. It also allows fast switching up to 1 MHz (vs. 25 kHz for single supply). |
| Replaces ZX76-31-XX-S+ series (XX=SN/SP/PN/PP) | Same case and pinout and provide wideband performance, to 4 GHz instead of 2.4 GHz. |



Digital Step Attenuator

50Ω DC-4000 MHz

31 dB, 1 dB Step

5 Bit, Serial control interface, Dual Supply Voltage

Product Features

- Low Insertion Loss
- High IP3, +52 dBm Typ
- Excellent return loss, 20 dB Typ
- Excellent accuracy, 0.1 dB Typ
- Fast switching control frequency, 1 MHz typ.
- Dual Supply Voltage: $V_{DD}=+3V$, $V_{SS}=-3.3V$
- Control inputs buffered by Schmitt Triggers
- Rigid unibody case
- Protected by US patent 6,790,049



Generic photo used for illustration purposes only
CASE STYLE: HK1149

ZX76-31A-SNS+

Typical Applications

- Lab
- Instrumentation
- Test equipment

| Connectors | Order P/N |
|------------|---------------|
| SMA | ZX76-31A-SNS+ |

+RoHS Compliant

The +Suffix identifies RoHS Compliance. See our web site for RoHS Compliance methodologies and qualifications

General Description

The ZX76-31A-SNS+ is a 50Ω digital step attenuator provides adjustable attenuation of 0 to 31 dB in 1 dB steps. The control is a 5-bit serial interface, and the attenuators operate with dual (positive and negative) supply voltage. The ZX76-31A-SNS+ is produced using a unique case package for ruggedness and operation in tough environments.

Simplified Schematic

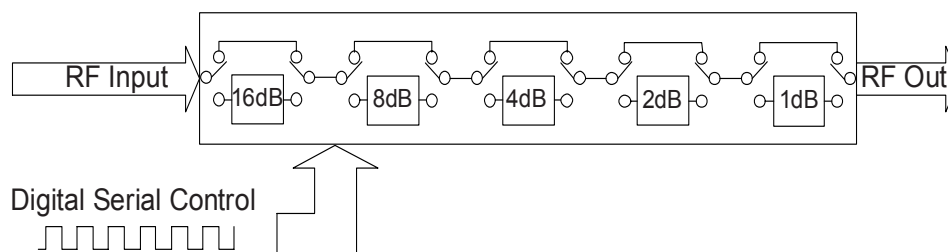

RF Electrical Specifications ^(Note1), DC-4000 MHz, T_{AMB}=25°C, V_{DD}=+3V, V_{SS}=-3.3V

| Parameter | Freq. Range (GHz) | Min. | Typ. | Max. | Units |
|--|-------------------|------|-------|------------|-------|
| Accuracy @ 1 dB Attenuation Setting | DC-1 | — | ±0.02 | ±0.10 | dB |
| | 1-2.4 | — | ±0.05 | ±0.15 | |
| | 2.4-4 | — | ±0.10 | ±0.25 | |
| Accuracy @ 2 dB Attenuation Setting | DC-1 | — | ±0.05 | ±0.15 | dB |
| | 1-2.4 | — | ±0.15 | ±0.25 | |
| | 2.4-4 | — | ±0.15 | ±0.35 | |
| Accuracy @ 4 dB Attenuation Setting | DC-1 | — | ±0.07 | ±0.20 | dB |
| | 1-2.4 | — | ±0.15 | ±0.25 | |
| | 2.4-4 | — | ±0.23 | ±0.50 | |
| Accuracy @ 8 dB Attenuation Setting | DC-1 | — | ±0.03 | ±0.25 | dB |
| | 1-2.4 | — | ±0.15 | ±0.50 | |
| | 2.4-4 | — | ±0.60 | ±0.80 | |
| Accuracy @ 16 dB Attenuation Setting | DC-1 | — | ±0.10 | ±0.30 | dB |
| | 1-2.4 | — | ±0.15 | ±0.70 | |
| | 2.4-4 | — | ±1.10 | ±1.45 | |
| Insertion Loss @ all attenuator set to 0dB | DC-1 | — | 1.4 | 2.0 | dB |
| | 1-2.4 | — | 1.9 | 2.7 | |
| | 2.4-4 | — | 2.5 | 3.3 | |
| Input IP3 ^(note 1) (at Min. and Max. Attenuation) | DC-4 | — | +52 | — | dBm |
| Input Power @ 0.2dB Compression ^(note 1) (at Min. and Max. Attenuation) | DC-4 | — | +24 | — | dBm |
| Input Operating Power | 10 kHz to 50 MHz | — | — | See Fig. 1 | dBm |
| | >50 MHz | — | — | +24 | |
| VSWR | DC-1 | — | 1.2 | 1.6 | :1 |
| | 1-2.4 | — | 1.3 | 1.7 | |
| | 2.4-4 | — | 1.45 | 1.9 | |

Notes:

1. Input IP3 and 1dB compression degrade below 1 MHz. Input power not to exceed max operating specification for continuous operation.

DC Electrical Specifications

| Parameter | Min. | Typ. | Max. | Units |
|----------------------------------|---------------------|------|---------------------|-------|
| V _{DD} , Supply Voltage | 2.7 | 3 | 3.6 | V |
| V _{SS} , Supply Voltage | -3.6 | -3.3 | -3.2 | V |
| I _{DD} Supply Current | — | — | 200 | µA |
| I _{SS} Supply Current | — | 16 | 40 | µA |
| Control Input Low | -0.3 | — | 0.3xV _{DD} | V |
| Control Input High | 0.7xV _{DD} | — | 5 | V |
| Control Current | — | — | 400 | µA |

Absolute Maximum Ratings ^(Note 2,3)

| Parameter | Ratings |
|------------------------------|-----------------------|
| Operating Temperature | -40°C to 85°C |
| Storage Temperature | -40°C to 85°C |
| V _{DD} | -0.3V Min., 5.5V Max. |
| V _{SS} | -3.6V Min., 0.3V Max. |
| Voltage on any control input | -0.3V Min., 6V Max. |
| ESD, HBM | 500V |
| ESD, MM | 100V |
| Input Power | +30dBm |

2. Permanent damage may occur if any of these limits are exceeded.

3. Operation between max operating and absolute max input power will result in reduced reliability.

Switching Specifications

| Parameter | Min. | Typ. | Max. | Units |
|--|------|------|------|-------|
| Switching Speed, 50% Control to 0.5dB of Attenuation Value | — | 1.0 | — | µSec |
| Switching Control Frequency | — | 1.0 | — | MHz |

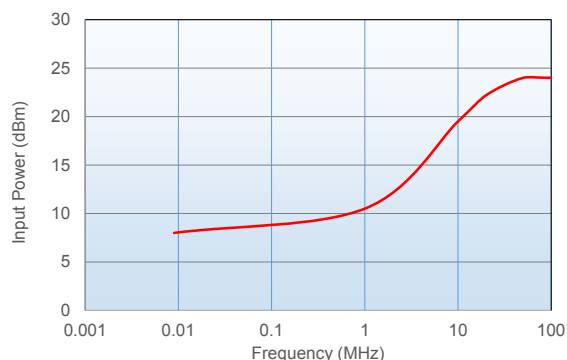

Figure 1. Max Input Operating Power vs Frequency

Pin Description

| Function | Pin Number | Description |
|-----------------|------------|------------------------------|
| N/C | J1-1 | Not Connected |
| GND | J1-2 | Ground connection |
| LE | J1-3 | Latch Enable Input |
| N/C | J1-4 | Not Connected |
| GND | J1-5 | Ground connection |
| N/C | J1-6 | Not Connected |
| Clock | J1-7 | Serial Interface clock Input |
| GND | J1-8 | Ground connection |
| Data | J1-9 | Serial Interface data Input |
| N/C | J1-10 | Not Connected |
| RF in | J2 | RF in port (Note 1) |
| RF out | J3 | RF out port (Note 1) |
| GND | P1 | Ground connection |
| V _{DD} | P2 | Positive Supply Voltage |
| GND | P3 | Ground connection |
| V _{SS} | P4 | Negative Supply Voltage |

Note 1: Both RF ports must be held at 0VDC or DC blocked with an external series capacitor.

Pin Configuration

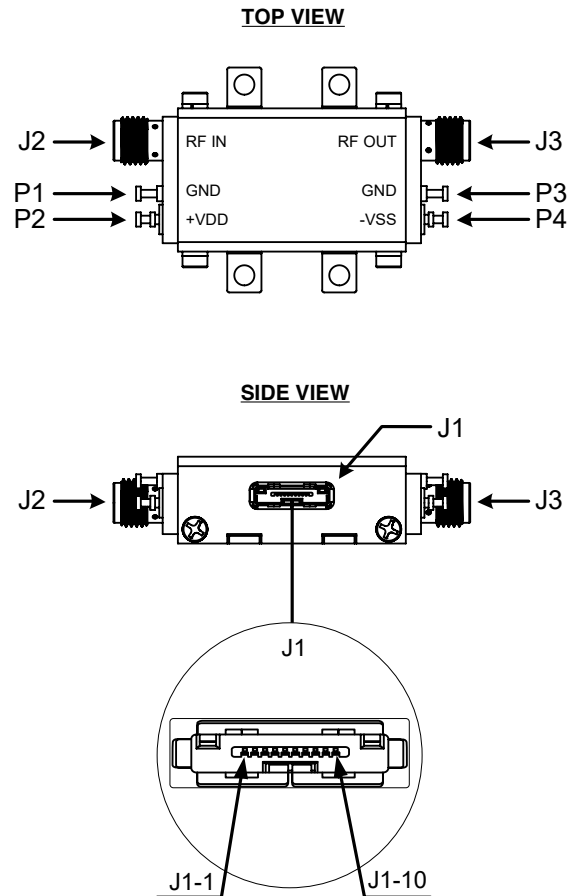

Cable Pin Description

| J1-Pin Number | J4-Pin Number | Function | Description | Wire Color |
|---------------|---------------|----------|------------------------------|------------|
| J1-2 | J4-18 | GND | Ground connection | BLACK |
| J1-3 | J4-4 | LE | Latch Enable Input | GREEN |
| J1-5 | J4-19 | GND | Ground connection | BLUE |
| J1-7 | J4-2 | Clock | Serial Interface clock Input | RED |
| J1-8 | J4-20 | GND | Ground connection | ORANGE |
| J1-9 | J4-3 | Data | Serial Interface data Input | WHITE |

Note: Other pins not connected. Cable shield connected to case ground.

Simplified Schematic

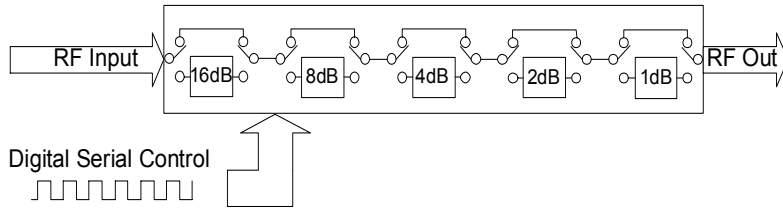

The ZX76-31A-SNS+ serial interface consists of 5 control bits that select the desired attenuation state, as shown in Table 1: Truth Table

| Attenuation State | C16 | C8 | C4 | C2 | C1 |
|-------------------|-----|----|----|----|----|
| Reference | 0 | 0 | 0 | 0 | 0 |
| 1 (dB) | 0 | 0 | 0 | 0 | 1 |
| 2 (dB) | 0 | 0 | 0 | 1 | 0 |
| 4 (dB) | 0 | 0 | 1 | 0 | 0 |
| 8 (dB) | 0 | 1 | 0 | 0 | 0 |
| 16 (dB) | 1 | 0 | 0 | 0 | 0 |
| 31 (dB) | 1 | 1 | 1 | 1 | 1 |

Note: Not all 32 possible combinations of C1 - C16 are shown in table

The serial interface is a 6-bit serial in, parallel-out shift register buffered by a transparent latch, with the first bit being '0' and the other five bits being the control bits.

It is controlled by three CMOS-compatible signals: Data, Clock, and Latch Enable (LE). The Data and Clock inputs allow data to be serially entered into the shift register, a process that is independent of the state of the LE input. The shift register triggers on the rising edge of the clock signal.

The LE input controls the latch. When LE is HIGH, the latch is transparent and the contents of the serial shift register control the attenuator. When LE is brought LOW, data in the shift register is latched.

The shift register should be loaded while LE is held LOW to prevent the attenuator value from changing as data is entered. The LE input should then be toggled HIGH and brought LOW again, latching the new data. The timing for this operation is defined by **Figure 2** (Serial Interface Timing Diagram) and **Table 2** (Serial Interface AC Characteristics).

Figure 2: Serial interface Timing Diagram

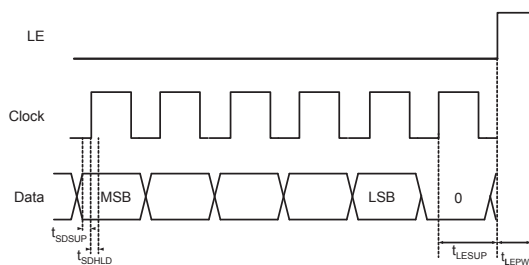

Table 2. Serial Interface AC Characteristics

| Symbol | Parameter | Min. | Max. | Units |
|-------------|--|------|------|-------|
| f_{clk} | Serial data clock frequency (Note 1) | | 10 | MHz |
| t_{clkH} | Serial clock HIGH time | 30 | | ns |
| t_{clkL} | Serial clock LOW time | 30 | | ns |
| t_{LESUP} | LE set-up time after last clock falling edge | 10 | | ns |
| t_{LEPW} | LE minimum pulse width | 30 | | ns |
| t_{SDSUP} | Serial data set-up time after clock falling edge | 10 | | ns |
| t_{SDHLD} | Serial data hold time after clock falling edge | 10 | | ns |

Note 1. f_{clk} verified during the functional pattern test. Serial programming sections of the functional pattern are clocked at 10MHz to verify f_{clk} specification.

Recommended Accessories

Two optional cable accessories with and without interface connector are available with ZX76-31A-SNS+, the ZX76-CS+ and ZX76-WS+. Cable length is 4.9 feet / 1.5 meters.

ZX76-CS+ shielded cable with interface 25 pin D-type connector J4 and supplied software are used to control the ZX76-31A-SNS+ digital attenuator from a computer, using LPT port.

ZX76-WS+ shielded cable without interface 25 pin D-type connector enables customer to use the ZX76-31A-SNS+ digital attenuator in his own application.

ZX76-CS+ Control Cable

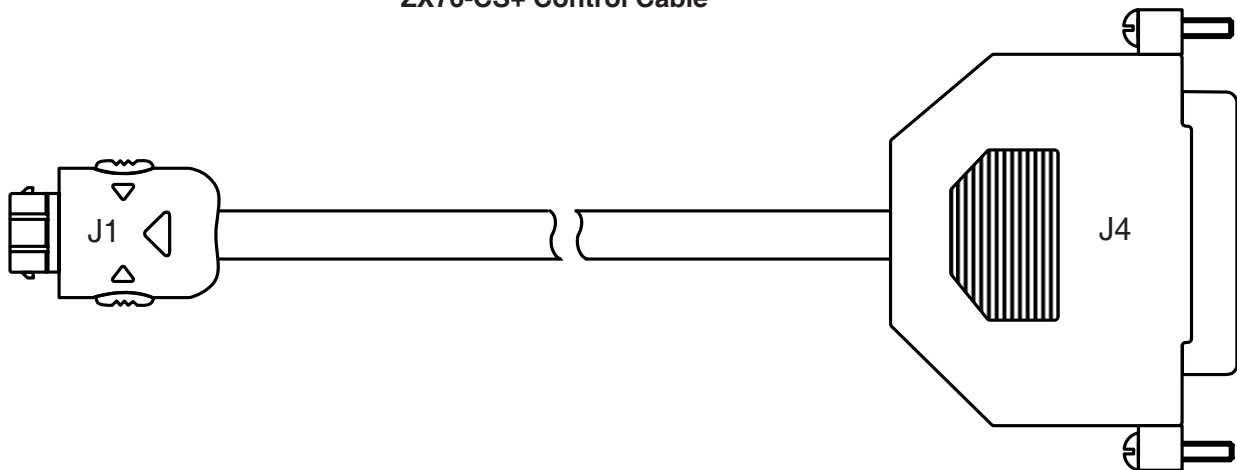

ZX76-CS+ wiring information

| J1-Pin Number | J4-Pin Number | Function | Description | Wire Color |
|---------------|---------------|----------|------------------------------|------------|
| J1-2 | J4-18 | GND | Ground connection | BLACK |
| J1-3 | J4-4 | LE | Latch Enable Input | GREEN |
| J1-5 | J4-19 | GND | Ground connection | BLUE |
| J1-7 | J4-2 | Clock | Serial Interface clock Input | RED |
| J1-8 | J4-20 | GND | Ground connection | ORANGE |
| J1-9 | J4-3 | Data | Serial Interface data Input | WHITE |

Note: Other pins not connected. Cable shield connected to case ground.

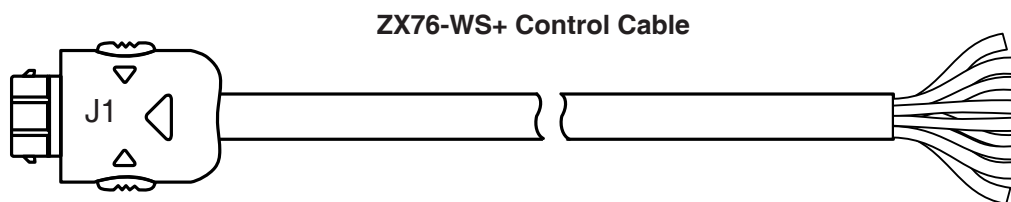

ZX76-WS+ wiring information

| J1-Pin Number | Function | Description | Wire Color |
|---------------|----------|------------------------------|------------|
| J1-2 | GND | Ground connection | BLACK |
| J1-3 | LE | Latch Enable Input | GREEN |
| J1-5 | GND | Ground connection | BLUE |
| J1-7 | Clock | Serial Interface clock Input | RED |
| J1-8 | GND | Ground connection | ORANGE |
| J1-9 | Data | Serial Interface data Input | WHITE |

Note: Other pins not connected. Cable shield connected to case ground.

Ordering Information

| Model Number | Description |
|---------------|---|
| ZX76-31A-SNS+ | Digital attenuator - Serial interface Dual Voltage (Negative and Positive) |
| ZX76-CS+ | Cable accessory with interface connector |
| ZX76-WS+ | Cable accessory without interface connector |

Additional Detailed Technical Information

additional information is available on our dash board. To access this information [click here](#)

| | |
|------------------------------|--|
| Performance Data | Data Table |
| | Swept Graphs |
| | S-Parameter (S2P Files) Data Set (.zip file) |
| Case Style | HK1149 |
| Environmental Ratings | ENV28T14 |

Additional Notes

- Performance and quality attributes and conditions not expressly stated in this specification document are intended to be excluded and do not form a part of this specification document.
- Electrical specifications and performance data contained in this specification document are based on Mini-Circuits' applicable established test performance criteria and measurement instructions.
- The parts covered by this specification document are subject to Mini-Circuits standard limited warranty and terms and conditions (collectively, "Standard Terms"); Purchasers of this part are entitled to the rights and benefits contained therein. For a full statement of the Standard Terms and the exclusive rights and remedies thereunder, please visit Mini-Circuits' website at www.minicircuits.com/MCLStore/terms.jsp

