



LTCC SMT

High Pass Filter

HFCG-2500+

50Ω 2.7 to 14.5 GHz

THE BIG DEAL

- Low Insertion Loss, 0.9 dB Typ.
- Return Loss, 11 dB Typ.
- Stop Band Rejection, 48 dB Typ.
- 0805 Surface Mount Footprint
- Power Handling: 4 Watts



Generic photo used for illustration purposes only

CASE STYLE: GE0805C-9

+RoHS Compliant

The +Suffix identifies RoHS Compliance. See our website for methodologies and qualifications

APPLICATIONS

- Test and Measurement Equipment
- Communications, Radar, EW, and ECM Defense Systems
- 5G MIMO and Back Haul Radio Systems
- 5G Sub 6 GHz
- WiFi 6E

PRODUCT OVERVIEW

HFCG-2500+ is a miniature low temperature co-fired ceramic (LTCC) high pass filter with a 2.7 to 14.5 GHz passband supporting a variety of applications. This model provides 0.9 dB typical insertion loss over a wide band due to its rugged monolithic construction. Housed in a tiny 0805 ceramic form factor with inspectable wrap-around terminations, the filter is ideal for dense signal chain PCB layouts where it complements MMIC size and performance. The LTCC fabrication process assures minimal RF performance variation while delivering a product that is well suited for environmental extremes of high humidity and temperature.

KEY FEATURES

Feature	Advantages
Small size, 0805	Accommodates tight space requirements for dense PCB layouts.
Wrap around termination	Provides excellent solderability and easy visual inspection capability.
LTCC construction	Provides a rugged package that is well suited for tough environments including high humidity and high temperature extremes.
Ultra-wide pass band	This filter has a very wide passband from 2.7 to 14.5 GHz.
Rugged Power handling	Handles up to 4 Watts in a small 0805 package.

REV. B
ECO-016177
HFCG-2500+
EDU4458
URJ
221220





LTCC SMT

High Pass Filter

HFCG-2500+

ELECTRICAL SPECIFICATIONS^{1,2} AT 25°C

Parameter		F#	Frequency (GHz)	Min.	Typ.	Max.	Units
Stopband	Rejection	DC-F1	DC - 1.55	42	48	—	dB
		F1-F2	1.55 - 1.95	20	30	—	
	Freq. Cut-Off	F3 ^(note 3)	2.5	—	3	—	
Passband	Insertion Loss	F4-F5	2.7 - 3.5	—	2.0	—	dB
		F5-F6	3.5 - 13.5	—	0.9	1.5	
		F6-F7	13.5 - 14.5	—	1.2	—	
	Return Loss	F4-F5	2.7 - 3.5	—	13	—	dB
		F5-F6	3.5 - 13.5	—	11	—	
		F6-F7	13.5 - 14.5	—	14	—	

1. This component should not be employed as a DC-block. DC blocking capacitors are required in applications where DC voltage and/or current is present at either input or output ports. Please contact Mini-Circuits for further support.

2. Measured on Mini-Circuits Characterization Test Board TB-HFCG-2500+

3. Typically, a ±5% frequency deviation from the stated value may occur on a unit-to-unit basis.

ABSOLUTE MAXIMUM RATINGS¹

Parameter	Ratings
Operating temperature	-55°C to 125°C
Storage temperature	-55°C to 125°C
RF Power Input ²	4W @25°C

1. Permanent damage may occur if any of these limits are exceeded.

2. Power rating applies only to signals within the passband. Power rating above +25°C should be derated linearly to 0.9W at +125°C.

TYPICAL FREQUENCY RESPONSE

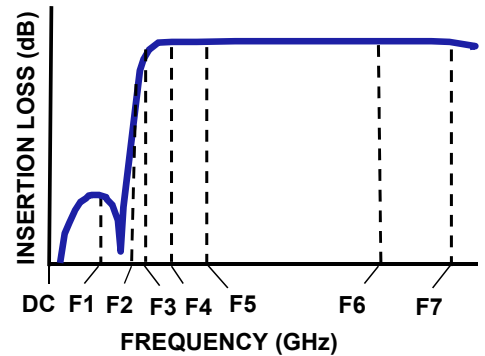

FUNCTIONAL DIAGRAM

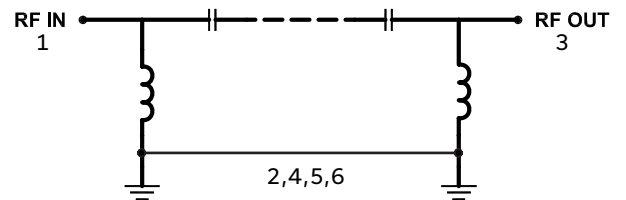



LTCC SMT

High Pass Filter

HFCG-2500+

PAD CONNECTIONS

RF IN	1
RF OUT	3
GROUND	2,4,5,6

PRODUCT MARKING: VU

DEMO BOARD MCL P/N: TB-HFCG-2500+
SUGGESTED PCB LAYOUT (PL-633)

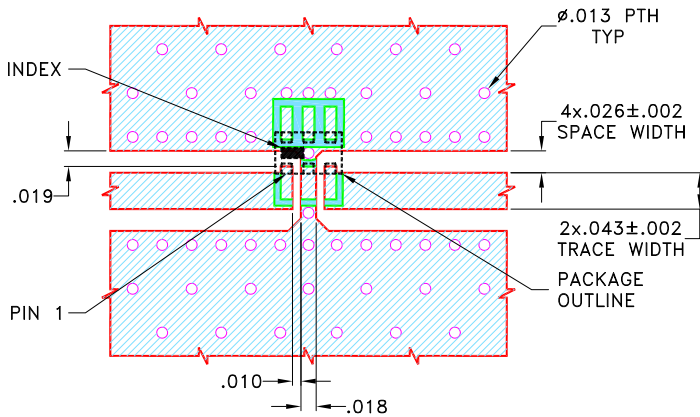

NOTES:

1. COPLANAR WAVEGUIDE PARAMETERS ARE SHOWN FOR ROGERS (R04350B) WITH DIELECTRIC THICKNESS $.020 \pm .0015$. COPPER: 1/2 Oz. EACH SIDE. FOR OTHER MATERIALS TRACE WIDTH AND GAP MAY NEED TO BE MODIFIED.
 2. BOTTOM SIDE OF THE PCB IS CONTINUOUS GROUND PLANE.
- DENOTES PCB COPPER PATTERN WITH SMOBC (SOLDER MASK OVER BARE COPPER)
 DENOTES PCB COPPER PATTERN FREE OF SOLDERMASK

OUTLINE DRAWING

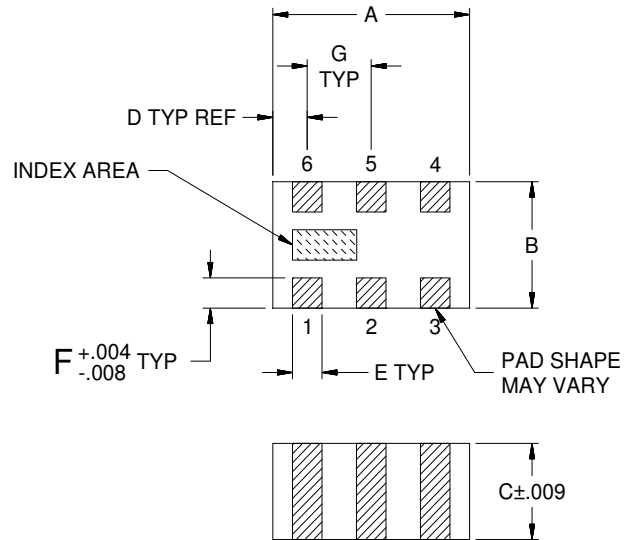

OUTLINE DIMENSIONS (Inches/mm)

A	B	C	D	E	F	G	Wt.
.079	.049	.037	.014	.012	.012	.026	grams
2.00	1.25	0.95	0.35	0.30	0.30	0.65	.008



LTCC SMT

High Pass Filter

HFCG-2500+

TYPICAL PERFORMANCE DATA AT 25°C

Frequency (MHz)	Insertion Loss (dB)	Return Loss (dB)
10	76.08	0.04
100	65.86	0.03
1000	48.66	0.12
1550	54.66	0.26
1950	31.74	0.41
2000	28.55	0.47
2100	22.40	0.67
2300	10.51	2.06
2500	2.65	11.94
2700	1.40	16.04
3500	0.55	30.24
5000	0.31	20.98
10000	0.31	16.50
13500	0.57	22.61
14500	0.79	19.66

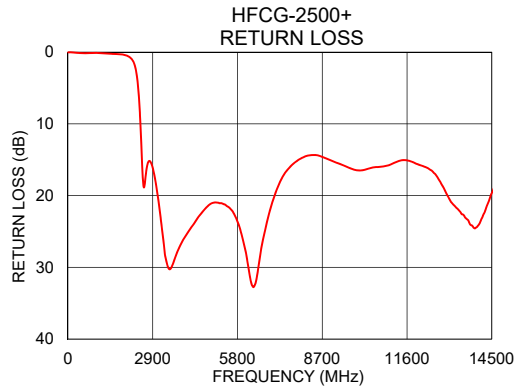
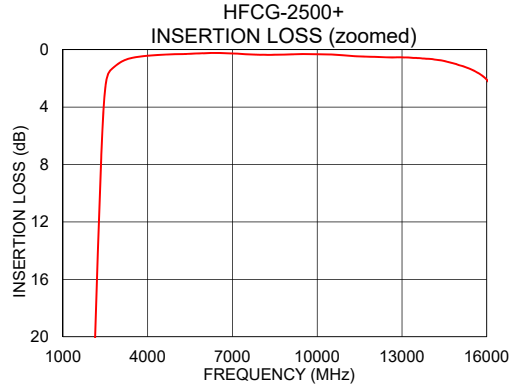
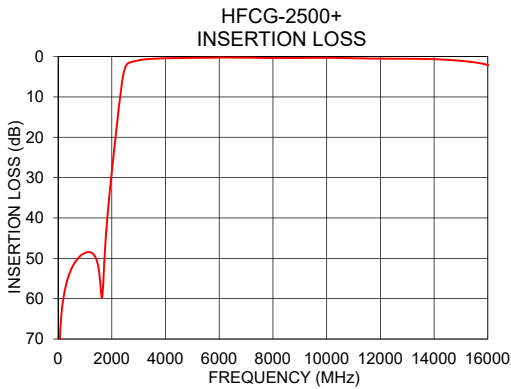

NOTES

- A. Performance and quality attributes and conditions not expressly stated in this specification document are intended to be excluded and do not form a part of this specification document.
- B. Electrical specifications and performance data contained in this specification document are based on Mini-Circuit's applicable established test performance criteria and measurement instructions.
- C. The parts covered by this specification document are subject to Mini-Circuits standard limited warranty and terms and conditions (collectively, "Standard Terms"); Purchasers of this part are entitled to the rights and benefits contained therein. For a full statement of the standard. Terms and the exclusive rights and remedies thereunder, please visit Mini-Circuits' website at www.minicircuits.com/MCLStore/terms.jsp



Typical Performance Data

FREQ. (MHz)	INSERTION LOSS			INPUT RETURN LOSS			OUTPUT RETURN LOSS		
	(dB)			(dB)			(dB)		
	@-55°C	@+25°C	@+125°C	@-55°C	@+25°C	@+125°C	@-55°C	@+25°C	@+125°C
10	75.98	76.08	75.97	0.00	0.04	0.06	0.08	0.12	0.14
50	71.83	72.58	72.14	0.01	0.03	0.05	0.08	0.12	0.15
100	65.69	65.86	65.92	0.02	0.03	0.05	0.09	0.13	0.16
200	59.75	59.75	59.78	0.01	0.07	0.09	0.11	0.16	0.19
300	56.39	56.45	56.45	0.05	0.10	0.14	0.14	0.19	0.22
400	54.16	54.16	54.19	0.07	0.13	0.18	0.15	0.20	0.25
500	52.51	52.54	52.55	0.09	0.15	0.21	0.16	0.22	0.27
600	51.25	51.29	51.30	0.08	0.15	0.22	0.17	0.23	0.29
700	50.28	50.32	50.36	0.07	0.15	0.21	0.17	0.25	0.31
800	49.54	49.58	49.60	0.05	0.13	0.20	0.18	0.26	0.32
900	48.96	49.04	49.06	0.03	0.12	0.19	0.19	0.27	0.34
1000	48.59	48.66	48.68	0.02	0.12	0.20	0.19	0.28	0.36
1100	48.38	48.46	48.49	0.03	0.14	0.22	0.19	0.29	0.37
1200	48.40	48.51	48.57	0.05	0.16	0.25	0.18	0.29	0.37
1300	48.73	48.88	49.00	0.08	0.19	0.29	0.18	0.29	0.38
1400	49.60	49.85	50.07	0.10	0.22	0.33	0.19	0.30	0.40
1500	51.72	52.25	52.76	0.12	0.25	0.36	0.20	0.32	0.43
1550	53.86	54.66	55.43	0.12	0.26	0.38	0.20	0.33	0.45
1600	57.70	58.54	58.58	0.12	0.26	0.39	0.21	0.35	0.47
1650	60.44	59.19	57.13	0.13	0.27	0.40	0.23	0.37	0.49
1700	56.04	53.55	51.18	0.13	0.28	0.41	0.24	0.38	0.52
1750	49.12	47.40	45.70	0.13	0.29	0.43	0.26	0.41	0.55
1800	43.97	42.64	41.28	0.14	0.31	0.46	0.28	0.44	0.59
1850	39.79	38.65	37.45	0.15	0.33	0.49	0.31	0.47	0.63
1950	32.72	31.74	30.68	0.20	0.41	0.60	0.38	0.56	0.74
2000	29.50	28.55	27.52	0.25	0.47	0.68	0.43	0.62	0.82
2100	23.33	22.40	21.40	0.42	0.67	0.94	0.58	0.82	1.06
2300	11.36	10.51	9.65	1.52	2.06	2.74	1.72	2.24	2.90
2470	3.47	3.26	3.14	7.40	9.25	11.43	8.22	10.17	12.59
2500	2.73	2.65	2.65	9.76	11.94	14.31	11.10	13.58	16.50
2700	1.22	1.40	1.59	15.99	16.04	15.80	17.18	16.84	16.40
3000	0.78	0.92	1.07	16.85	18.13	19.27	17.04	18.34	19.46
3200	0.57	0.72	0.86	22.06	24.08	26.31	22.33	24.44	27.00
3500	0.40	0.55	0.69	28.83	30.24	29.24	29.62	31.00	30.72
3700	0.33	0.48	0.63	28.31	28.28	26.13	27.44	27.91	26.60
4000	0.27	0.42	0.56	25.77	25.77	23.94	24.87	25.72	24.80
4200	0.24	0.39	0.53	24.34	24.55	23.23	23.71	24.62	24.08
4400	0.22	0.36	0.50	23.00	23.36	22.66	22.56	23.51	23.40
4600	0.20	0.34	0.48	21.75	22.28	22.18	21.68	22.68	23.02
4800	0.17	0.32	0.45	20.65	21.41	21.87	21.05	22.14	22.95
5000	0.16	0.31	0.45	20.26	20.98	22.09	20.92	21.88	23.20
5200	0.16	0.31	0.44	20.48	21.06	22.96	21.18	21.92	23.88
5400	0.14	0.29	0.43	20.73	21.34	23.93	21.67	22.31	24.86
5600	0.12	0.27	0.42	21.31	22.03	25.75	22.59	23.30	26.75
5800	0.10	0.26	0.41	22.64	23.60	29.02	24.36	25.22	29.26
6000	0.09	0.25	0.40	25.21	26.42	35.58	26.93	27.97	30.47
6200	0.07	0.23	0.40	29.08	30.65	35.35	30.77	31.66	29.17
6400	0.06	0.23	0.40	31.76	32.38	28.56	31.97	31.35	26.10
6600	0.06	0.23	0.42	28.34	27.73	24.29	27.69	26.73	23.11
6800	0.08	0.25	0.43	24.50	23.87	21.57	23.66	23.06	20.90
7000	0.08	0.26	0.44	21.27	20.84	19.50	20.82	20.42	19.25
7500	0.13	0.32	0.49	16.62	16.46	16.35	16.71	16.61	16.73
8000	0.15	0.35	0.52	14.66	14.77	15.30	14.80	15.03	15.91
8500	0.15	0.35	0.52	14.03	14.37	15.30	14.28	14.74	16.09
9000	0.12	0.33	0.52	14.55	15.10	16.31	14.49	15.16	16.67
9500	0.08	0.30	0.52	15.31	15.92	17.24	15.21	15.87	17.28
10000	0.08	0.31	0.56	15.92	16.50	17.80	15.70	16.20	17.23
11000	0.14	0.40	0.69	15.32	15.74	16.20	15.17	15.40	15.72
13500	0.25	0.57	0.90	21.97	22.61	23.81	23.10	23.56	25.08
14500	0.39	0.79	1.14	19.52	19.66	22.31	20.30	20.33	23.88

Typical Performance Data

FREQ. (MHz)	GROUP DELAY		
	(nsec)		
	@-55°C	@+25°C	@+125°C
2700	0.70	0.67	0.64
3000	0.44	0.43	0.42
3300	0.32	0.32	0.32
3500	0.28	0.27	0.27
3800	0.22	0.22	0.22
4100	0.19	0.19	0.18
4400	0.16	0.16	0.16
4700	0.14	0.14	0.14
5000	0.12	0.12	0.13
5300	0.11	0.11	0.11
5600	0.10	0.10	0.11
5900	0.10	0.10	0.10
6200	0.09	0.09	0.09
6500	0.09	0.09	0.09
6800	0.08	0.08	0.08
7100	0.08	0.08	0.08
7400	0.07	0.07	0.08
7700	0.07	0.07	0.07
8000	0.07	0.07	0.07
8300	0.07	0.07	0.07
8600	0.07	0.07	0.07
8900	0.07	0.07	0.07
9200	0.07	0.07	0.07
9500	0.07	0.07	0.07
9800	0.07	0.07	0.07
10100	0.07	0.07	0.07
10400	0.07	0.07	0.07
10700	0.07	0.07	0.07
11000	0.07	0.07	0.07
11300	0.07	0.07	0.07
11600	0.07	0.07	0.07
11900	0.07	0.07	0.07
12200	0.07	0.07	0.07
12500	0.07	0.07	0.08
12800	0.07	0.08	0.08
13100	0.08	0.08	0.08
13500	0.08	0.08	0.09
13700	0.08	0.09	0.09
14000	0.09	0.09	0.10
14500	0.10	0.10	0.11

Typical Performance Curves

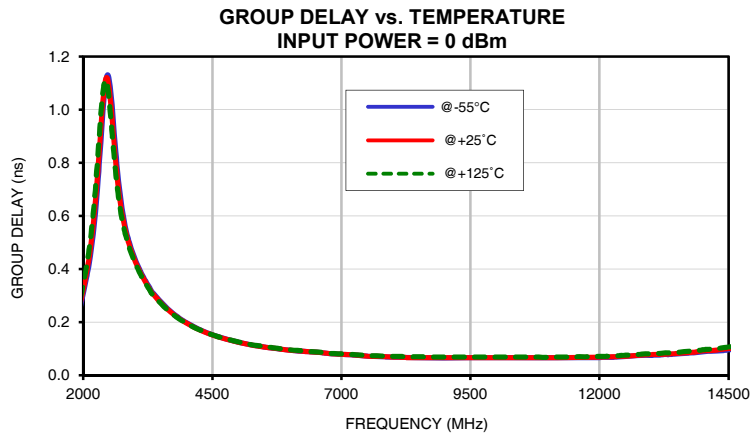
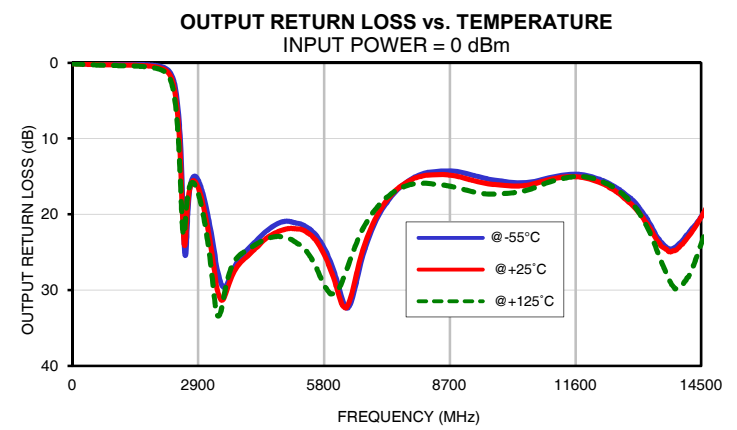
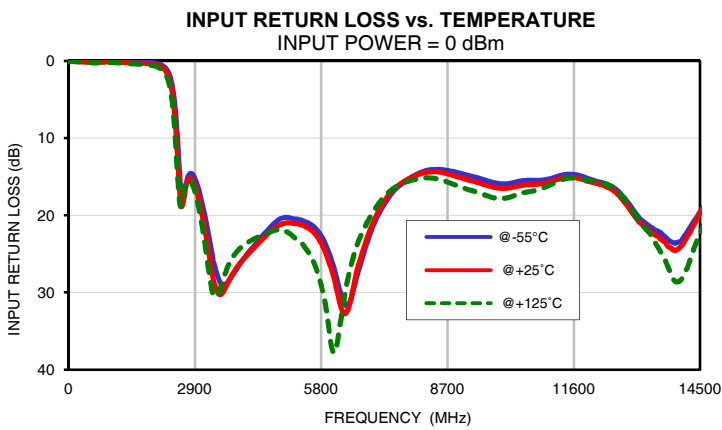
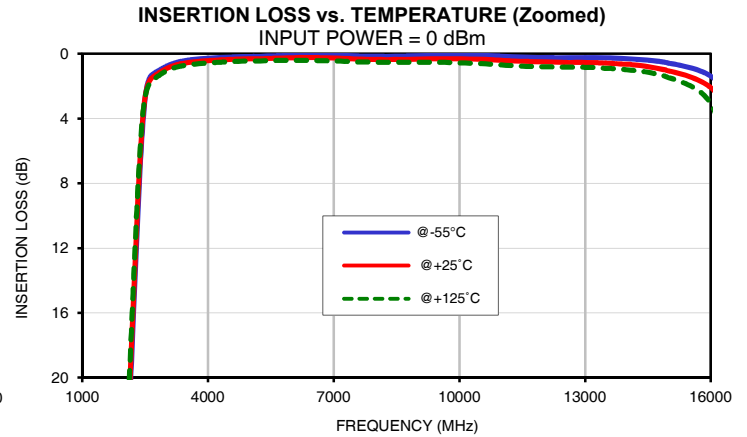
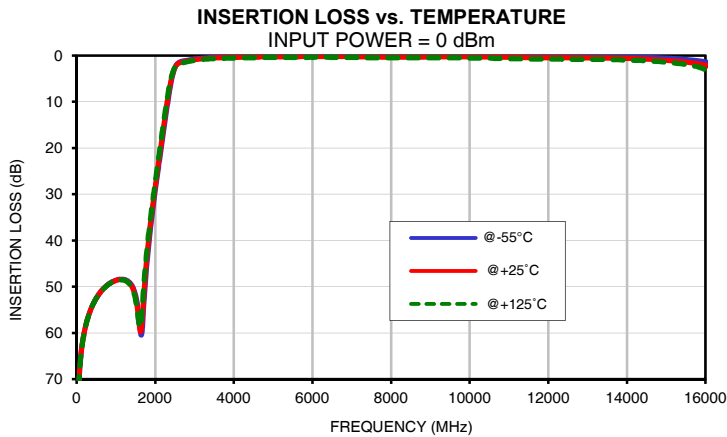

Outline Dimensions

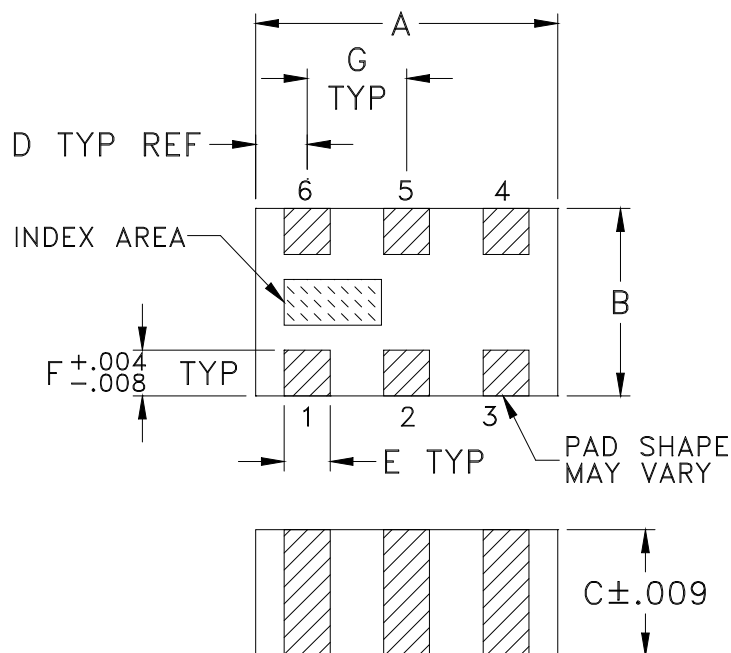

PCB Land Pattern

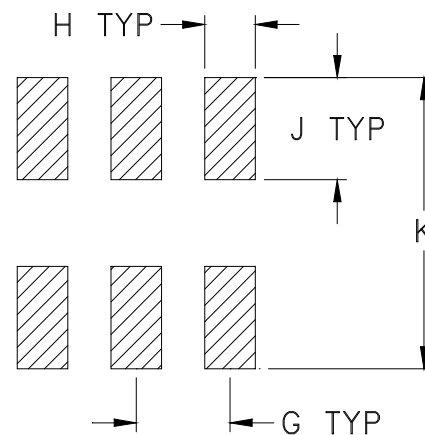

Suggested Layout,
Tolerance to be within ± 0.002

CASE #	A	B	C	D	E	F	G	H	J	K	WT.GRAM
GE0805C-9	.079 (2.00)	.049 (1.25)	.037 (0.95)	.014 (0.35)	.012 (0.30)	.012 (0.30)	.026 (0.65)	.014 (0.35)	.039 (1.00)	.110 (2.80)	.008

Dimensions are in inches (mm). Tolerances: 2Pl. $\pm .01$; 3 Pl. $\pm .005$

Notes:

- Open style, ceramic base.
- Termination finish: For RoHS Case Styles: Tin plate over Nickel plate. All models, (+) suffix.
For RoHS-5 Case Styles: Tin-Lead plate over Nickel plate. All models, no (+) suffix.



P.O. Box 350166, Brooklyn, New York 11235-0003 (718) 934-4500 Fax (718) 332-4661 For detailed performance specs & shopping online see Mini-Circuits web site



Provides ACTUAL Data Instantly From MINI-CIRCUITS At: www.minicircuits.com

RF/IF MICROWAVE COMPONENTS

Tape & Reel Packaging TR-F114

DEVICE ORIENTATION IN T&R

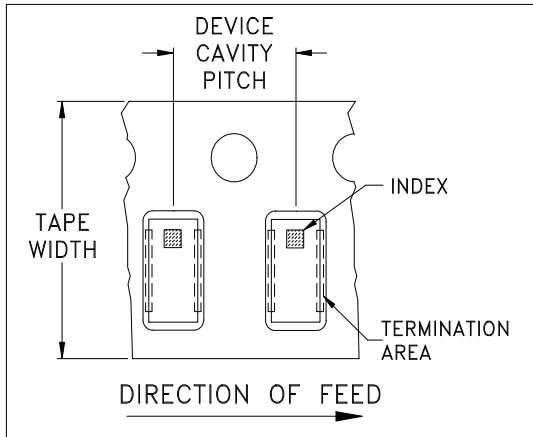

ILLUSTRATION 1

Applicable Case Styles	
GE0805C	JC0603C
GE0805C-1	JC0603C-4
GE0805C-1AP	JC0603C-6
GE0805C-7	
GE0805C-9	
GE0805C-10	
GE0805C-11	
GE0805C-12	

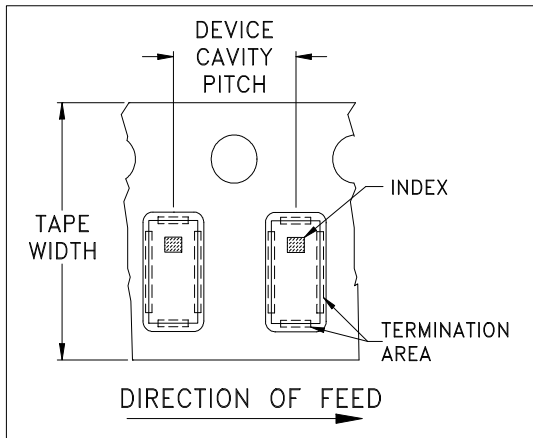

ILLUSTRATION 2

Applicable Case Styles	
GE0805C-2	JC0603C-1
GE0805C-3	JC0603C-2
GE0805C-4	JC0603C-3
GE0805C-5	JC0603C-5
GE0805C-6	JC0603C-7
GE0805C-8	JV1210C-1
GE0805C-15	

Tape Width, mm	Device Cavity Pitch, mm	Reel Size, inches	Devices per Reel	
8	4	7	Small quantity standards (see note)	20
				50
				100
				200
				500
				1000
			Standard	4000

Note: Please Consult individual model data sheet to determine device per reel availability.

Mini-Circuits carrier tape materials provide protection from ESD (Electro-Static Discharge) during handling and transportation. Tapes are static dissipative and comply with industry standards EIA-481/EIA-541.

Go to: www.minicircuits.com/pages/pdfs/tape.pdf



INTERNET <http://www.minicircuits.com>

P.O. Box 350166, Brooklyn, New York 11235-0003 (718) 934-4500 Fax (718) 332-4661

Distribution Centers NORTH AMERICA 800-654-7949 • 417-335-5935 • Fax 417-335-5945 • EUROPE 44-1252-832600 • Fax 44-1252-837010

Mini-Circuits ISO 9001 & ISO 14001 Certified

THIRD ANGLE PROJECTION

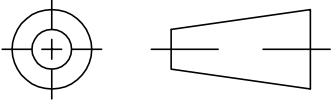

REVISIONS

REV OR	ECN No.	DESCRIPTION	DATE	DR	AUTH
	M174039	NEW RELEASE	MAY 19	DDR	VC

SUGGESTED MOUNTING CONFIGURATION FOR
GE0805C-9 CASE STYLE "06FL02" PIN CODE

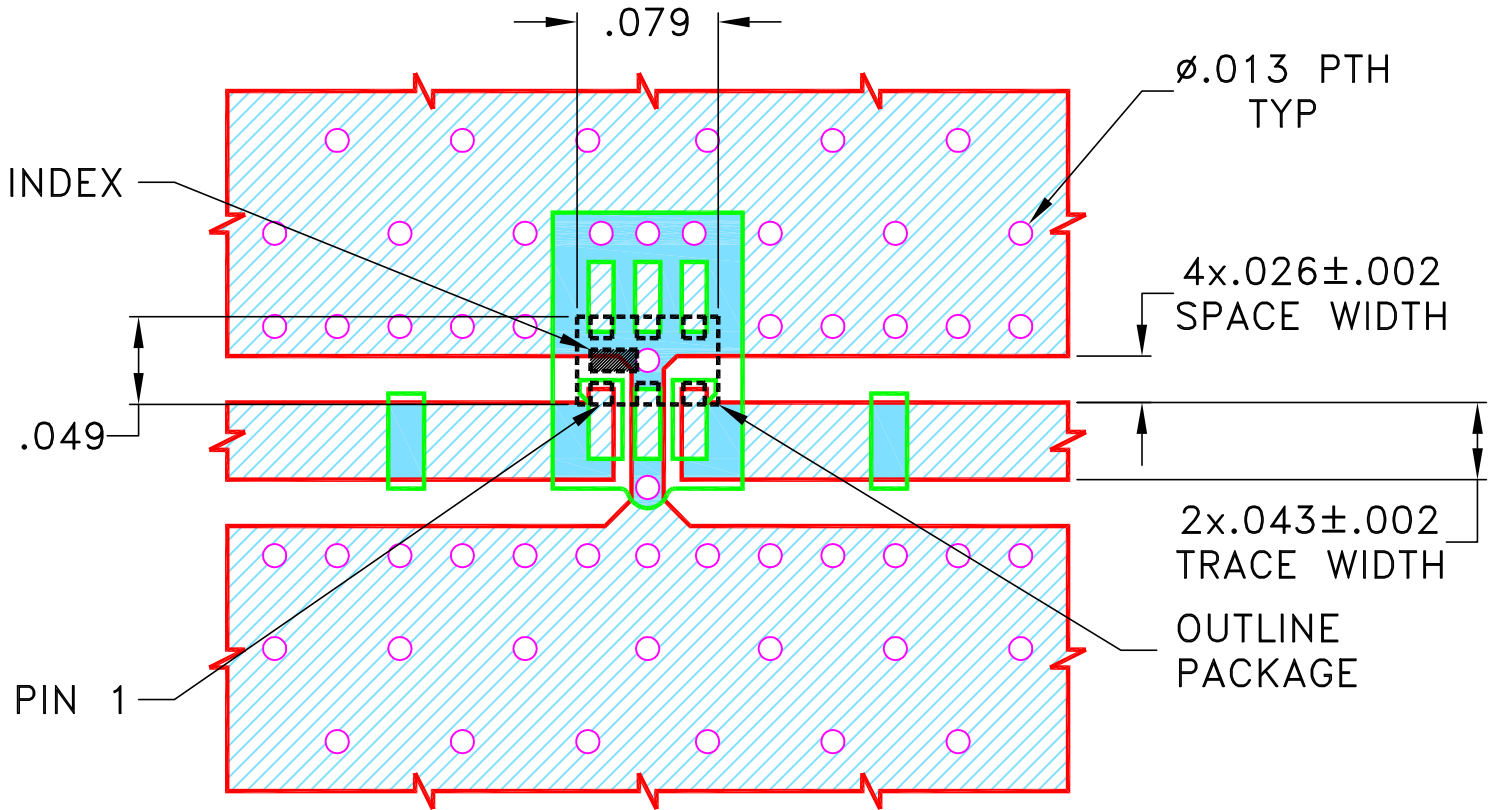

NOTES:

1. TRACE WIDTH IS SHOWN FOR ROGERS (R04350B) WITH DIELECTRIC THICKNESS .020"±.0015". COPPER: 1/2 Oz. EACH SIDE.
FOR OTHER MATERIALS TRACE WIDTH MAY NEED TO BE MODIFIED.
2. BOTTOM SIDE OF THE PCB IS CONTINUOUS GROUND PLANE.



DENOTES PCB COPPER LAYOUT WITH SMOBC
(SOLDER MASK OVER BARE COPPER)



DENOTES COPPER LAND PATTERN FREE OF SOLDERMASK

UNLESS OTHERWISE SPECIFIED	INITIALS	DATE
DIMENSIONS ARE IN INCHES	DRAWN DDR	08 MAY 19
TOLERANCES ON: 2 PL DECIMALS ±	CHECKED RV	08 MAY 19
3 PL DECIMALS ± .005"	APPROVED RKS	08 MAY 19
ANGLES ±		
FRACTIONS ±		



Mini-Circuits® 13 Neptune Avenue
Brooklyn NY 11235

PL, 06FL02, GE0805C-9
TB-1104+, 50 OHM

SIZE	CODE IDENT	DRAWING NO:	REV:
A	15542	98-PL-633	OR
FILE:	98PL633	SCALE:	9:1
		SHEET:	1 OF 1

THIS DOCUMENT AND ITS CONTENTS ARE THE PROPERTY OF MINI-CIRCUITS. EXCEPT FOR USE EXPRESSLY GRANTED, IN WRITING, TO ITS VENDORS, VENDEE AND THE UNITED STATES GOVERNMENT, MINI-CIRCUITS RESERVES ALL PROPRIETARY DESIGN, USE, MANUFACTURING AND REPRODUCTION RIGHTS THERETO. THESE CONTENTS SHALL NOT BE USED, DUPLICATED OR DISCLOSED TO ANY OUTSIDE PARTY, IN WHOLE OR IN PART, WITHOUT WRITTEN PERMISSION OF MINI-CIRCUITS.

Evaluation Board and Circuit

TB-HFCG-2500+

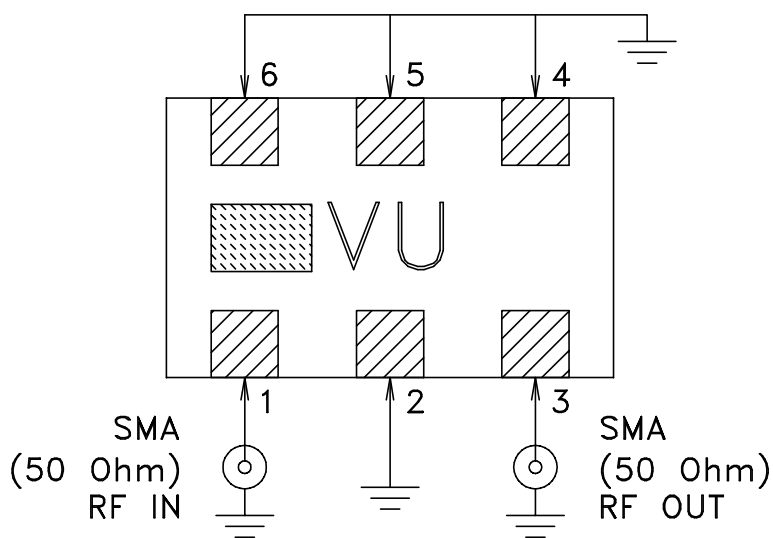
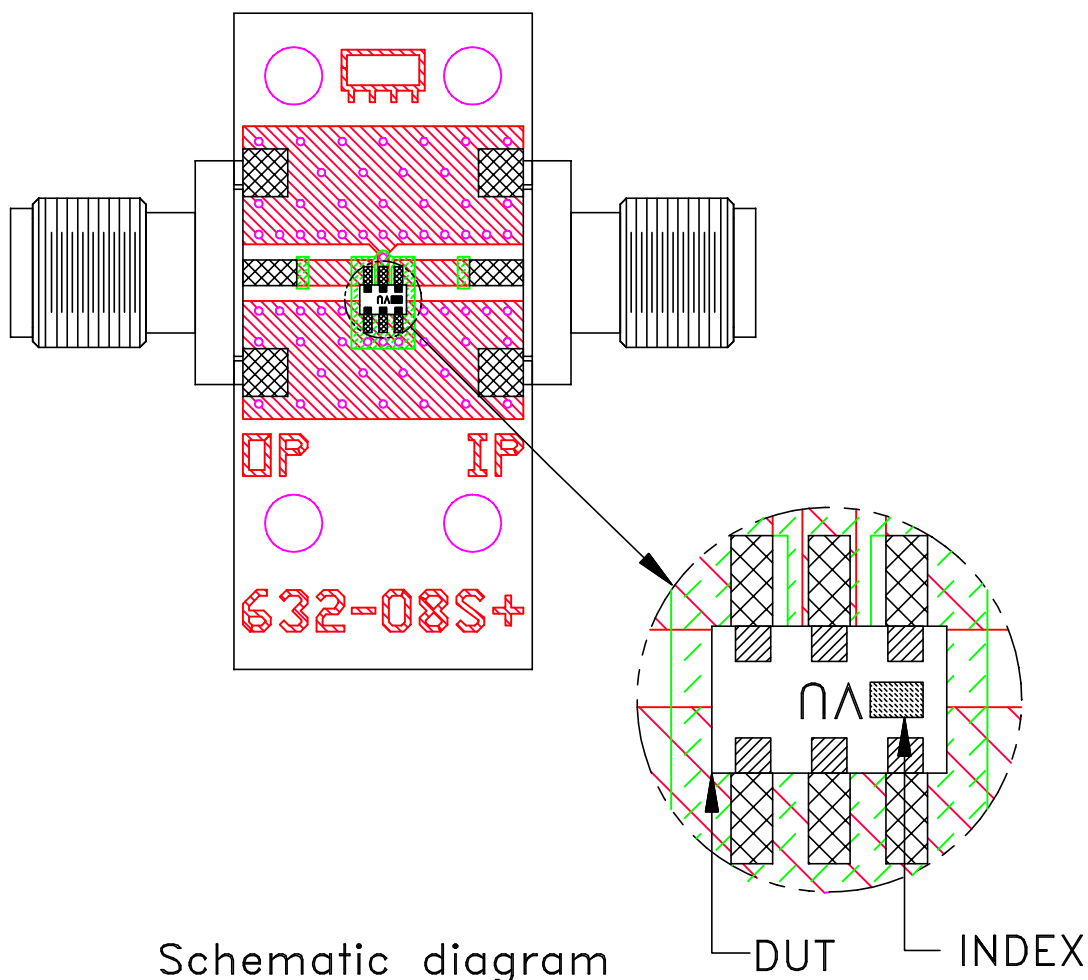

Notes:

1. PCB Material: ROGERS (R04350B) OR Equivalent, Dielectric Constant= 3.48 ± 0.05
Dielectric Thickness: $.020 \pm .0015$ inch
2. 50 Ohm SMA Female Connectors.

 **Mini-Circuits®**

All Mini-Circuits products are manufactured under exacting quality assurance and control standards, and are capable of meeting published specifications after being subjected to any or all of the following physical and environmental test.

Specification	Test/Inspection Condition	Reference/Spec
Operating Temperature	-55° to 125° C Ambient Environment	Individual Model Data Sheet
Storage Temperature	-55° to 125° C Ambient Environment	Individual Model Data Sheet
Humidity	90 to 95% RH, 240 hours, 50°C	MIL-STD-202, Method 103, Condition A, Except 50°C and end-point electrical test done within 12 hours
Solder Reflow Heat	Sn-Pb Eutectic Process 225°C peak Pb-Free Process 245° - 250°C peak	J-STD-020C, Table 4-1, 4-2 and 5-2, Figure 5-1
Solderability	10X Magnification	J-STD-002, Para 4.2.5, Test S, 95% Coverage
Vibration (High Frequency)	20g peak, 10-2000 Hz, 12 times in each of three perpendicular directions (total 36)	MIL-STD-202, Method 204, Condition D
Mechanical Shock	50g, 11 ms, 1/2-sine, 18 shocks: 3 each direction, each of 3 axes	MIL-STD-202, Method 213, Condition A