

Evaluation Board and Circuit

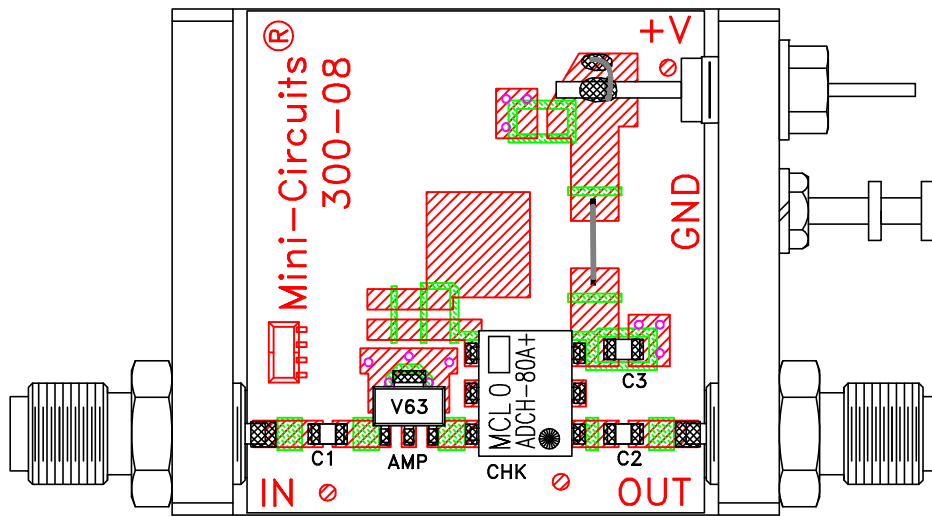

TB-410-83+

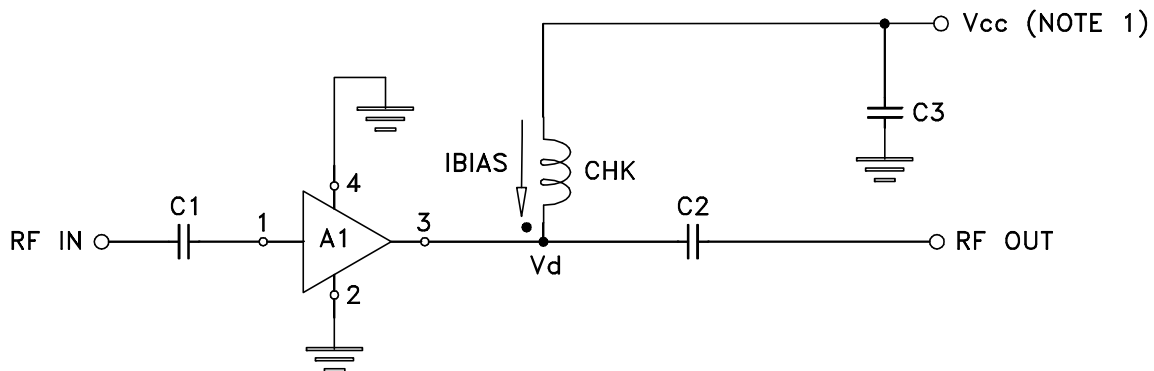

COMPONENT	VALUE
A1	GVA-83+
C1 (NOTE 4)	2400 pF
C2 (NOTE 4)	2400 pF
C3 (bypass)	0.1 uF
CHK	Mini-Circuits ADCH-80A+

Schematic Diagram

- NOTE:**
1. Vcc voltage: $+5 \pm 0.2V$.
 2. SMA Female connectors.
 3. PCB material: Rogers R04350 or equivalent, dielectric constant=3.5, dielectric thickness=.030 inch.
 4. Capacitors, C1 & C2 should be free of resonance up to the highest frequency specified.

 **Mini-Circuits®**