

Evaluation Board and Circuit

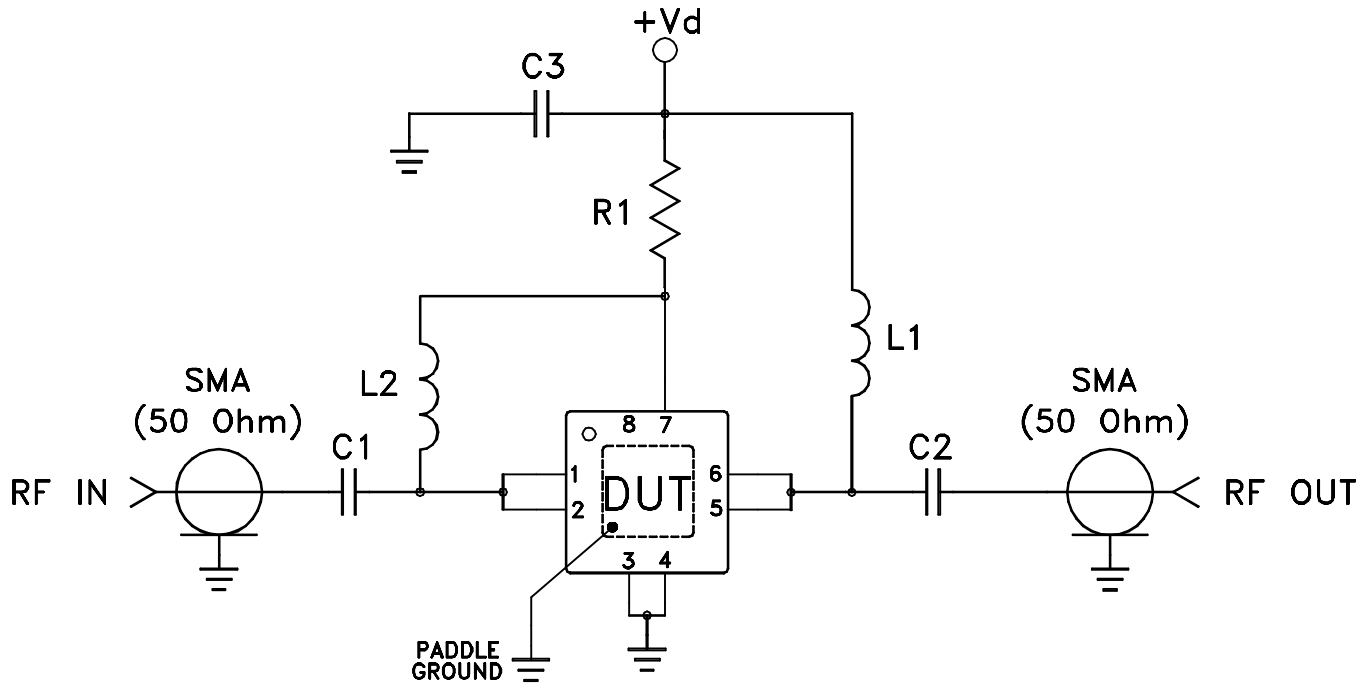
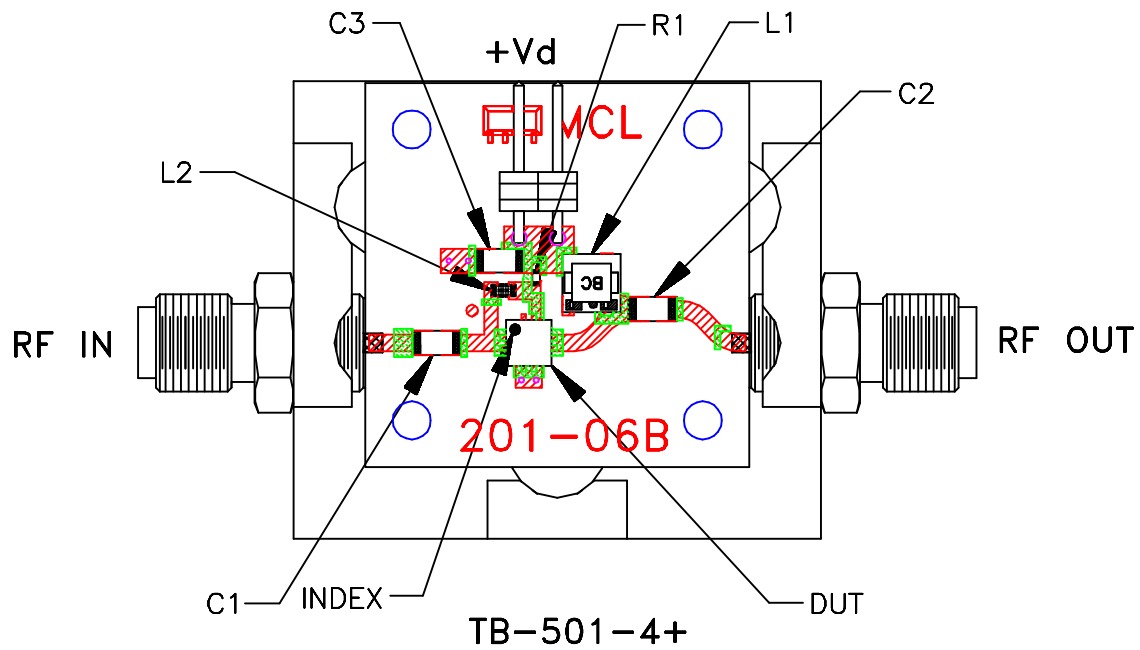

COMPONENT	VALUE/PART NUMBER
DUT	Mini-Circuits PMA-5454+
C1, C2, C3	0.1 uF
L1	Mini-Circuits TCCH-80+
L2	390 nH
R1	7.5k Ohm

Notes:

- 50 Ohm SMA Female connectors.
- PCB Material: R04350 or equivalent,
Dielectric Constant=3.5, Thickness=.020 inch.

Schematic Diagram

 **Mini-Circuits®**