

Evaluation Board and Circuit

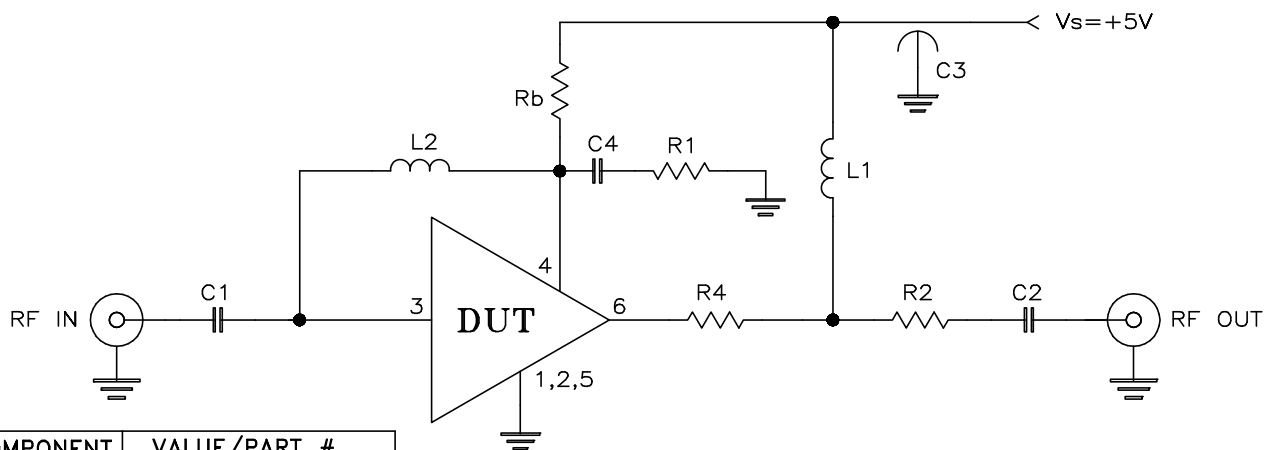
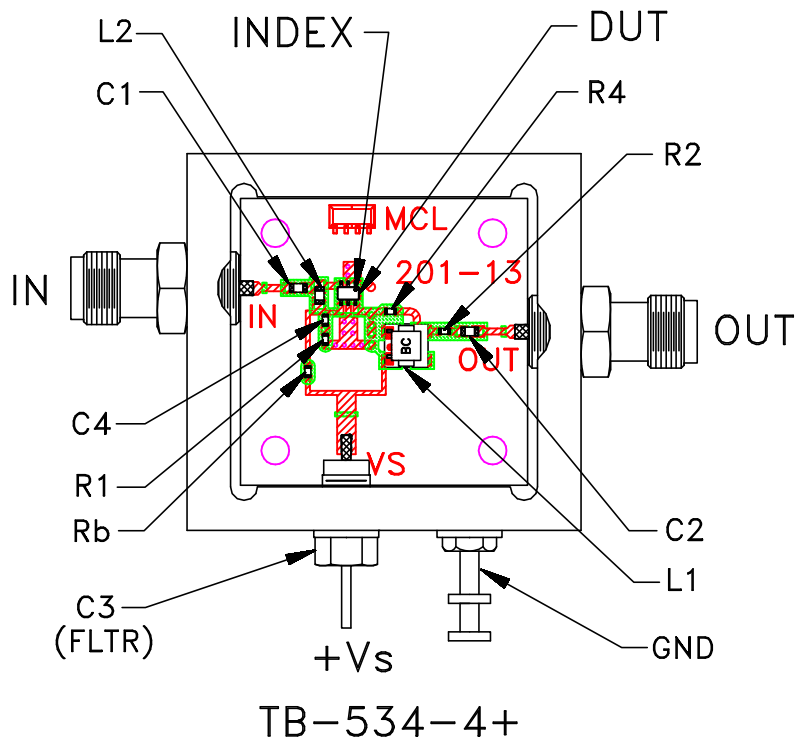

COMPONENT	VALUE/PART #
R1	49.9 Ω
R2, R4	0 Ω
Rb	7.5 k Ω
C1, C2	1000 pF
C3 (FLTR)	1500 pF
C4	10 pF
L1	TCCH-80+, MCL
L2	180 nH
DUT	PSA-5454+, MCL

Schematic Diagram

Notes:

1. 50 Ohm SMA Female connectors.
2. PCB Material: R04350 or equivalent,
Dielectric Constant=3.5, Thickness=.010 inch.

 **Mini-Circuits®**