

Evaluation Board and Circuit

For Pin Connections refer to Data Sheet of the DUT

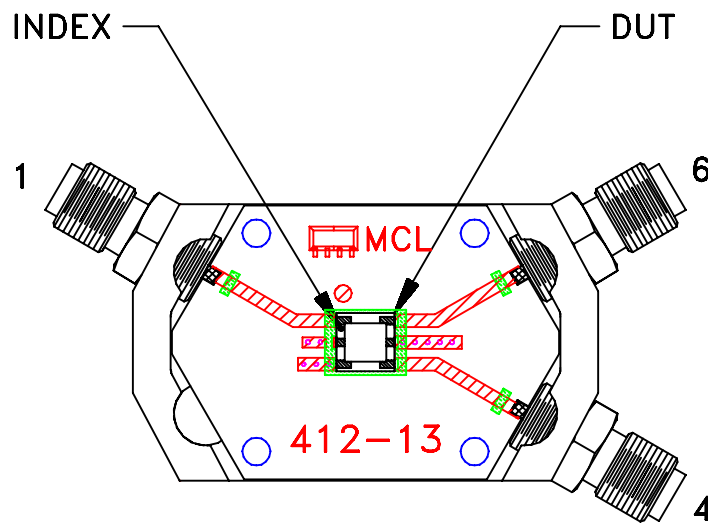

TB-575+

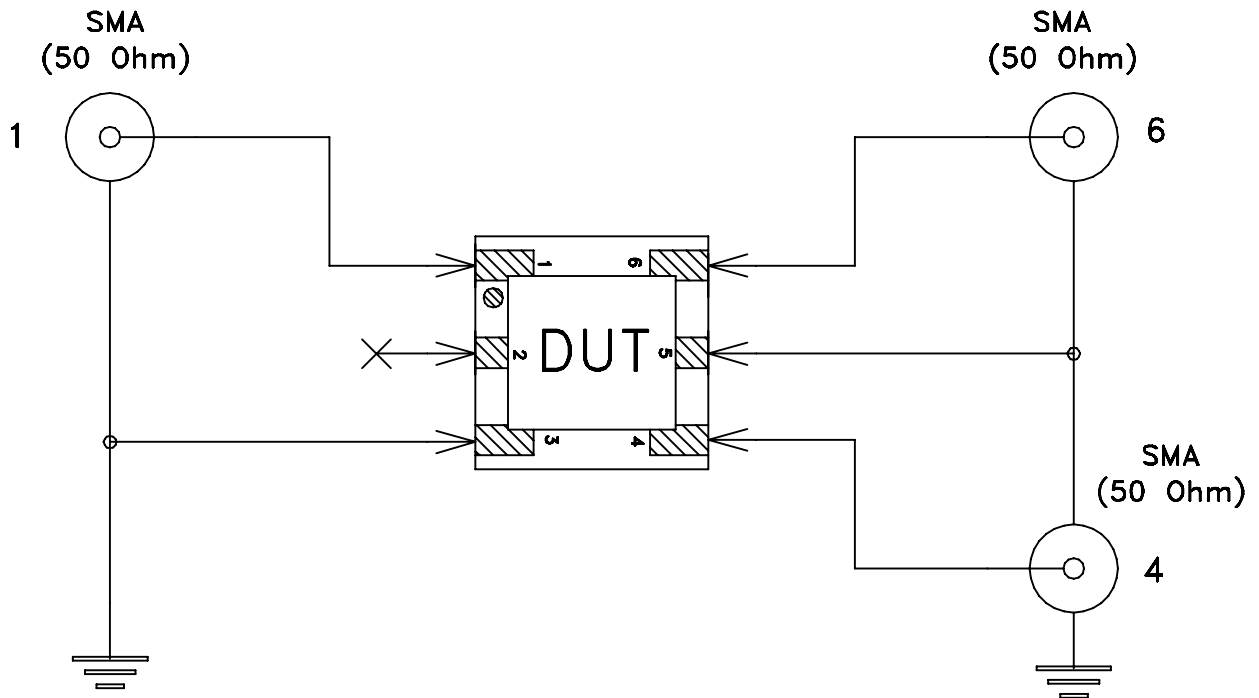

Schematic Diagram

Notes:

1. 50 Ohm SMA Female connectors.
2. PCB Material: R04350 or equivalent, Dielectric Constant=3.5, Thickness=.020 inch.

 **Mini-Circuits®**